Blend4Web. User Manual

Release v17.12.0

Triumph LLC

December 29, 2017

1	Overview	1
1.1	What's Blend4Web	1
1.2	"About Engines"	1
1.3	Graphics Engine, Game Engine	1
1.4	What's WebGL	2
1.5	WebGL Browsers Support	2
1.6	Advantages of WebGL	3
1.7	What's Blender	3
1.8	3D Modeling	3
1.9	Browser Technologies	4
1.10	Interactive Graphics	5
1.11	Video Cards and Drivers	5
2	Engine Features	6
3	Blender User Interface	13
3.1	3D View	14
3.2	Timeline	14
3.3	Graph Editor	15
3.4	Dope Sheet	15
3.5	NLA Editor	15
3.6	UV/Image Editor	16
3.7	Video Sequence Editor	16
3.8	Movie Clip Editor	17
3.9	Text Editor	17
3.10	Node Editor	18
3.11	Logic Editor	18
3.12	Properties	19
3.13	Outliner	26
3.14	User Preferences	27
3.15	Info	30
3.16	File Browser	31
3.17	Python Console	31

4	Installing and Updating	32
4.1	Installation	32
4.2	Updating	36
5	Workflow	39
5.1	Creating a New Project	41
5.2	Creating Scenes	41
5.3	Preparing a Scene to Use in Blend4Web	42
5.4	Exporting Scenes	42
5.5	Application Development	43
5.6	Project Building	43
5.7	Project Deploying	43
6	Project Management	45
6.1	Project Manager	46
6.2	Advanced Project Management	62
7	Scene Viewer	70
7.1	Navigation	71
7.2	The Side Panel	71
7.3	Indicators	82
8	Web Player	84
8.1	Usage	86
8.2	Navigation	86
8.3	Control Panel	86
8.4	Attributes	87
8.5	Scene Name as Title	88
8.6	Scene Errors	88
9	Add-on	90
9.1	Local Development Server	90
9.2	Running Viewer and Demos	94
9.3	Export Formats	95
9.4	Export Options	96
9.5	Initialization Errors	100
9.6	Compatibility Errors	101
9.7	Critical Export Errors	103
9.8	Non-Critical Export Errors	104
9.9	Other Messages	110
9.10	Add-on Translations	111
10	Scene Settings	113
10.1	Render Panel	115
10.2	Scene Panel	126
10.3	World Panel	134
11	Objects	139
11.1	Types	140

11.2	Static and Dynamic Objects	140
11.3	Settings	141
11.4	Object Constraints	148
11.5	Anchor Settings	150
11.6	Object Transform API	151
11.7	Get Object API	152
11.8	Object Selection	153
11.9	Copying Objects (Instancing)	154
11.10	Quaternions	155
11.11	Moving via TSR Vectors	158
11.12	Line Rendering	158
11.13	Levels Of Detail	159
12	Meshes	164
12.1	Static and Dynamic Meshes	164
12.2	Settings	165
12.3	Morphing	166
13	Normal Editor	168
13.1	Main Features of the Normal Editor	171
13.2	Interface	171
13.3	Activate	171
13.4	Show Normals	172
13.5	Rotate	172
13.6	Scale	173
13.7	Absolute and Offset Modes	174
13.8	Split Normals	174
13.9	Average	175
13.10	Restore	176
13.11	3D Cursor, Axis and Face	177
13.12	Copy/Paste	179
13.13	Copy From Mesh	180
14	Camera	183
14.1	Move Styles and General Settings	183
14.2	Limiting the Camera Movement	185
14.3	Viewport Alignment	193
14.4	Camera Controls API	195
15	Materials	201
15.1	Lighting Parameters	202
15.2	Transparency	203
15.3	Reflection	205
15.4	Rendering Properties	208
15.5	Viewport Properties	209
15.6	Engine Specific Parameters	210
15.7	Halo Materials	210
15.8	Material API	212
15.9	Inherit Material	215

16	Material Library	217
16.1	Library Structure	218
16.2	Material Structure	219
16.3	Adding Material to a Scene	223
17	Node Materials	226
17.1	Standard Nodes	227
17.2	Engine-Specific Nodes	228
17.3	Cycles Nodes	239
17.4	Limitations	240
18	Logic Editor	242
18.1	Basics	242
18.2	Control Flow	245
18.3	Animation	253
18.4	Camera	257
18.5	Object	261
18.6	Operations	268
18.7	Sound	273
18.8	Network	274
18.9	Time	279
18.10	Layout	283
18.11	Debug	285
18.12	Other Features	286
19	Lighting, Shadows and Background	287
19.1	Shading Types	287
19.2	Lighting with Light Sources	289
19.3	Environment Lighting (Ambient)	290
19.4	Shadows	292
19.5	Background	299
20	Postprocessing Effects	302
20.1	Motion Blur	302
20.2	Depth of Field	303
20.3	Screen-Space Ambient Occlusion	305
20.4	God Rays	307
20.5	Bloom	308
20.6	Outlining	309
20.7	Glow	310
20.8	Anti-Aliasing	311
21	VR and AR	312
21.1	Virtual Reality	312
21.2	Augmented Reality	316
22	Textures	318
22.1	Texture Types	318
22.2	Generic Settings	319

22.3	Diffuse Map	320
22.4	Specular Map	321
22.5	Normal Map	321
22.6	Height Map. Parallax Mapping	322
22.7	Stencil Map	323
22.8	Video Textures	325
22.9	Environment Map	327
22.10	Mirror Map	329
22.11	Skydome	330
22.12	Special Texture Types	332
23	Particle System. Fluids	336
23.1	Usage	337
23.2	Setup	338
23.3	Textures in Particle Systems	343
24	Particle System. Instancing	346
24.1	Particle System Setup	348
24.2	Grass	353
24.3	Tree Leaves	354
25	Animation	358
25.1	Animation Control	359
25.2	Object Animation	359
25.3	Skinning and Skeletal Animation	360
25.4	Vertex Animation	363
25.5	Default Animation	364
25.6	Non-Linear Animation	365
25.7	Audio Source Parametrization	367
25.8	Animation of Value and RGB Nodes	367
26	Outdoor Effects	370
26.1	Water	371
26.2	Atmosphere	379
26.3	Lens Flare	382
26.4	Wind	384
27	Color Management	388
27.1	Gamma Overview	388
27.2	Human Vision and Monitors	389
27.3	Gamma Formula	389
27.4	Gamma in Node Materials	390
27.5	Alpha Compositing	391
27.6	Color Correction	392
28	Audio	393
28.1	Audio Source Settings	394
28.2	Audio Mixer	397
28.3	Processing and Decoding	398

29	Physics	399
29.1	Preparing for Use	399
29.2	Static Physics Type	400
29.3	Dynamic Physics Type	401
29.4	Constraints	403
29.5	Wheeled Vehicles	405
29.6	Floating Objects	407
29.7	Floating Vehicles aka Watercrafts	408
29.8	Characters	409
29.9	Navigation Meshes	413
29.10	Use in Applications	416
30	For Application Developers	419
30.1	Application Development	419
30.2	Background Transparency	426
30.3	Resource Conversion	428
30.4	GZIP Compression	434
30.5	Code Examples	435
30.6	Loading Application Assets	436
30.7	Event-Driven Model	436
30.8	SDK File Structure	438
30.9	Loading Local Resources	441
30.10	Quality Profiles	441
30.11	Non-Standard Canvas Position and Orientation	443
30.12	Mobile Web Apps	444
31	For Engine Developers	446
31.1	Coding Style	446
31.2	Building the Engine	448
31.3	Building the Add-on	448
31.4	Dependencies	449
31.5	Naming Functions and Variables	449
31.6	Debugging	450
31.7	Shader Compilation	450
31.8	Updating Add-on Translations	456
32	Team Work. Using Git	457
32.1	Overview	457
32.2	Typical Workflow	458
32.3	Individual Settings	458
32.4	Checking the Status	459
32.5	Before the Commit	459
32.6	Preparing for Commit	460
32.7	Commit	462
32.8	Syncing Between Repositories	462
32.9	Resolving Conflicts	464
32.10	Tags	467
32.11	Other Useful Commands	467

33	Problems and Solutions	469
33.1	WebGL Support	469
33.2	Problems Upon Startup	470
33.3	WebGL Failed to Initialize	471
33.4	More In-Depth Troubleshooting	476
33.5	Known Issues	476
34	Release Notes	479
34.1	v17.12	479
34.2	v17.10	481
34.3	v17.08	483
34.4	v17.06	486
34.5	v17.04	487
34.6	v17.02	490
34.7	v16.12	495
34.8	v16.11	497
34.9	v16.10	500
34.10	v16.09	503
34.11	v16.08	505
34.12	v16.07	507
34.13	v16.06	509
34.14	v16.05	512
34.15	v16.04	515
34.16	v16.03	518
34.17	v16.02	520
34.18	v16.01	524
34.19	v15.12	527
34.20	v15.11	530
34.21	v15.10	534
34.22	v15.09	537
34.23	v15.08	541
34.24	v15.07	544
34.25	v15.06	547
34.26	v15.05	552
34.27	v15.04	555
34.28	v15.03	559
34.29	v15.02	562
34.30	v15.01	565
34.31	v14.12	569
34.32	v14.11	571
34.33	v14.10	572
34.34	v14.09	574
	Index	578

What's Blend4Web

Blend4Web is a web-oriented 3D engine - a software framework for authoring and interactive rendering of three-dimensional graphics and audio in browsers.

The platform is intended for visualizations, presentations, online-shops, games and other rich internet applications.

The Blend4Web framework is integrated tightly with Blender - a 3D modeling and animation tool (hence the name). The content is rendered by means of WebGL and other browser technologies, without the use of plugins.

Technically Blend4Web is a library for web pages, a Blender add-on and some tools for debugging and optimization.

The Blend4Web 3D engine has been developed by Triumph LLC employees since 2010. The engine was first released on March 28 2014.

“About Engines”

An engine is a separate part of software code which is used by external applications for implementing the required functionality.

Engine examples are: site engine, blog engine, online shop engine, wiki engine, search engine, game engine etc. The economical reason for the existence of software engines is multiple usage of the same functionality. For example developers may create relatively cheap online shops or games using one or another engine.

Graphics Engine, Game Engine

A graphics engine performs special functions in displaying graphics. It is an intermediary between:

- high-level application part (game logic, business logic) and
- low-level system part (for example, the graphics library [WebGL](#) and underlying drivers).

A graphics engine may be combined with the sound system, the physics engine, the artificial intelligence system, the networking system and the scene and logic editors producing a three-dimensional engine - an integrated environment for authoring 3D applications.

What's WebGL

WebGL (Web Graphics Library) is one of the modern browser technologies which allows authoring 3D graphics applications. In other words WebGL is “3D in a browser”.

WebGL Browsers Support

At the moment WebGL is supported in to a varying degree by all browsers.

Desktop Browsers

- Chrome
- Yandex Browser
- Firefox
- Opera
- Safari 8+
- Internet Explorer 11
- Microsoft Edge

Mobile Platforms

- Android
- BlackBerry
- Firefox OS
- iOS 8
- Sailfish OS
- Tizen
- Ubuntu Touch

For further details see the [dedicated section](#) in the Problems and Solutions chapter.

Advantages of WebGL

- works in browsers without installing additional software (plugins)
- crossplatform, intended for all desktop and embedded systems
- [open standard](#), does not require licensing fees
- supported by the leading participants of the IT market (Google, Apple, Microsoft, Nvidia, Samsung, Adobe and others)
- based on OpenGL which is familiar to developers
- can be integrated with other [browser technologies](#)

What's Blender

Blender is a popular piece of software for 3D modeling and animation and is free and open source. Models and scenes which are created in this software can be displayed, for example, by means of a [three-dimensional engine](#) on a web page.

3D Modeling

Authoring graphics resources requires trained specialists - 3D artists.

A typical workflow may include the following stages:

- choosing photos and/or creating concepts and sketches (views from the front - from the side - from the above) of the future model or scene
- modeling - a 3D model consisting of polygons is created
- UV mapping - the model is unwrapped for further overlaying of textures (flat images)
- texturing - textures are overlaid on the 3D model
- materials setup - materials are assigned for different parts of the model and tuned (for example, a wooden door with a metal handle)
- rigging - the controlling elements (“skeletal bones”) are attached to the model to animate it
- animation - the model is set in motion to visualize actions for example - of characters
- export - can be performed on any stage to display the 3D model in its final form, for example, on a web page

In addition, realism improving techniques are often used in the process of creating 3D models which require additional stages:

- creating a high-poly model - a detailed version of the model is created
- “baking” of a normal map - details from the high-poly model are transferred to the main model in the form of a special texture (normal map)
- creating a specular map - different reflection color and ratio are assigned to different model parts
- baking environment maps - is performed to visualize the surrounding environment reflection on the model surface
- setting up the camera and the light sources on the scene
- physical simulation parameters setup - particles, cloth

The time required to author 3D models and animation depends on their complexity and required quality and may vary from 1-2 days (for example a game item) to 1-2 weeks (for example a detailed aircraft model) and even to several months (realistic characters with clothing, hair, face sets, with animation and figure parameters setup).

Browser Technologies

Browser is a program for viewing Internet content. At the dawn of Internet technologies the browser’s role was to view text pages with the inclusion of static images (“hyper-text”). Modern browsers are full-scale platforms for multimedia web applications.

Among the already implemented and promising browser features which are used in Blend4Web the following technologies can be noted:

- three-dimensional graphics, [WebGL](#)
- [Typed Array](#)
- Timing control for script-based animations ([requestAnimationFrame](#))
- two-dimensional graphics, [HTML Canvas 2D Context](#)
- sound processing, [Web Audio API](#)
- binary data loading, [XMLHttpRequest Level 2](#)
- [Fullscreen](#)
- [Pointer Lock](#)
- multithreading, [Web Workers](#)
- [Device Orientation](#)

Other promising technologies:

- [Scalable Vector Graphics \(SVG\)](#)
- safe file access, [File API](#), [File API: Directories and System](#)

- real-time communication between browsers, [WebRTC](#)
- persistent network connection, [The WebSocket API](#)
- [Gamepad](#)

Interactive Graphics

Applied to computer graphics the term “interactive” means that the user can interact with a constantly changing image. For example the user can change the view direction in a 3D scene, move the objects, trigger animation and carry out other actions normally associated with computer games.

Graphics interactivity is achieved by utilizing a frequent change of images, so the user action (for example a mouse movement or the pressing of a key) between frames leads to the image changing in the next frame. Images must replace each other so frequently that the human eye could not recognize them individually (at least 30 frames per second).

“Real-time graphics” or “real-time rendering” are also similar in meaning to the term.

Video Cards and Drivers

Interactive graphics is provided by a special-purpose hardware part of modern computers so called graphics processor which can be implemented as a discrete device (video card) or as a part of the central processing unit.

Main graphics processors vendors for desktop computers are: - Nvidia (GeForce, Quadro), AMD (Radeon), Intel (HD), for embedded devices - ARM (Mali), PowerVR (SGX), Nvidia (Tegra), Qualcomm (Adreno) (trade marks are specified in brackets).

Program access to graphics processor resources is carried out via an intermediate program called driver. It’s important for the correct working of interactive graphics programs to have drivers of the latest version in the system. Drivers can be installed (or upgraded) from corresponding websites of graphics processors vendors. See detailed info in the section [WebGL Failed to Initialize](#).

Engine Features

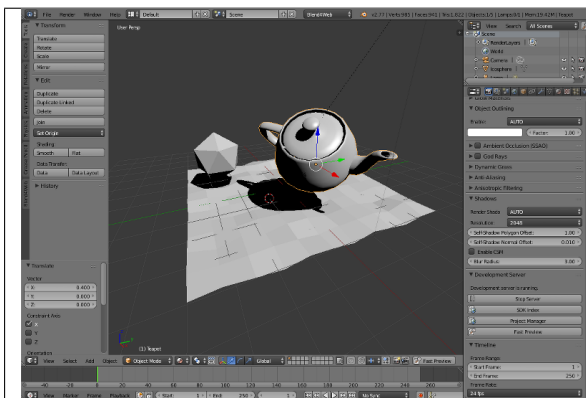

BLENDER INTEGRATION

Creating interactive applications has never been easier! You can simply create a 3D scene in Blender and then use it in Blend4Web with the help of the following features:

- Fast and Convenient Scene Export
- One-Click Scene Preview
- Full Support for Blender's Environment and Material Settings
- Tools for Creating and Managing Projects

RENDERING

Blend4Web offers a great many features to make your creations look amazing.

Some of them include:

- 3D Scenes of Any Complexity
- Cascaded Shadow Mapping
- Dynamic Foliage
- Particle Systems
- Level of Detail
- Post-processing Effects
- VR Support





MATERIALS

Powerful and easy-to-use material creation system makes it possible to create any material you might need, from a simple cartoon-like to an almost photo-real one.

Some of the features:

- Node Materials
- Parallax Offset Mapping
- Render-To-Texture
- Video Textures
- Full Support for Blender Material Nodes
- Refractions and Reflections

ANIMATION

Blend4web supports almost every animation technique available in Blender, including:

- Skeletal Animation
- Vertex Animation
- Object Animation
- Wind Bending
- Material Animation
- Animation Baking
- Flow Control Using API or Logic Editor



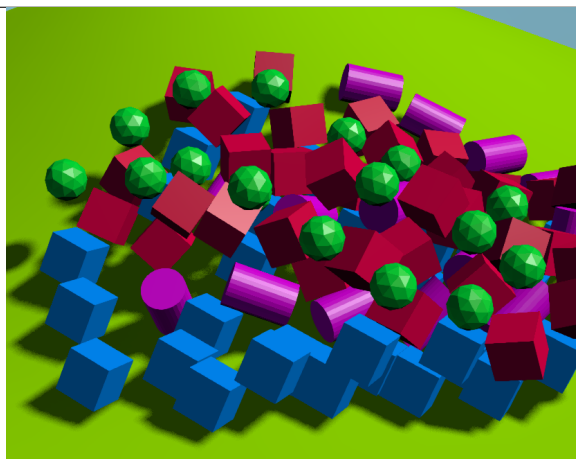

PHYSICS

If you are creating a physical simulation or simply want your scene to behave realistically, then Blend4Web's powerful physics system is at your service.

Its features include:

- Collisions
- Rigid Body Physics
- Joint System
- Ray Casting
- Floating Objects
- Vehicles

SOUND

Sound is important in making scenes and applications feel more responsive to user's actions and generally more alive.

Here are some of the means that Blend4Web offers you to control how your creations will sound:

- Flexible Playback Control
- 3D Positioning
- Doppler Effect
- Dynamic Compressor
- Cross-fade Sound Animation
- Real-Time Mixing

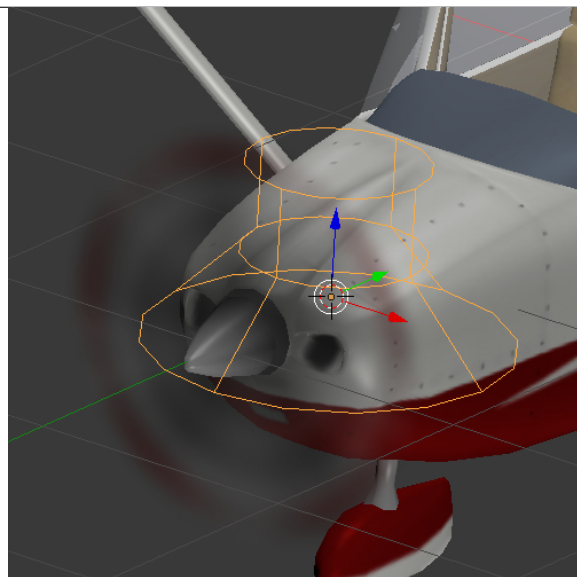

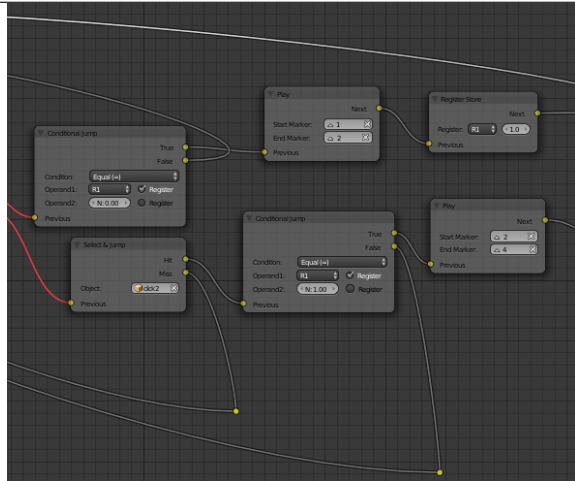

LOGIC EDITOR

Using this visual editor, you can create logic node trees to control the behavior of your scenes and to add interactivity without writing single line of code!

Logic Node Editor features:

- Object Picking
- Animation Control
- Variables and Computations
- Server Data Exchange

SCRIPTING

Blend4Web uses JavaScript scenarios to control every aspect of an application. Some Blend4Web's JavaScript API features include:

- Module Structure
- Event-Driven Model
- GLSL Shaders
- Code Minification and Obfuscation

```
"use strict"

// register the application module
b4w.register("simple_app", function(exports, require) {}

// import modules used by the app
var m_app      = require("app");
var m_data     = require("data");

/**
 * export the method to initialize the app (called at 0ms)
 */
exports.init = function() {
  m_app.init({
    canvas_container_id: "main_canvas_container",
    callback: init_cb,
    show_fps: true,
    console_verbose: true,
    autoresize: true
  });
}
```

Blender User Interface

Table of Contents

- Blender User Interface
 - 3D View
 - Timeline
 - Graph Editor
 - Dope Sheet
 - NLA Editor
 - UV/Image Editor
 - Video Sequence Editor
 - Movie Clip Editor
 - Text Editor
 - Node Editor
 - Logic Editor
 - Properties
 - Outliner
 - User Preferences
 - Info
 - File Browser
 - Python Console

Blender is a free open source 3D creation suite that supports an entire 3D pipeline from objects modeling to texturing, rigging and animating to rendering, compositing and even video editing. Blender can also be used to create interactive application, including web-based ones.

Blender is a cross-platform software that runs on Windows, Linux and macOS platforms equally well.

Blender interface consists of several windows. The number and types of windows present on the screen is not strictly defined and can be changed by a user manually or by selecting a preset from the Screen Layout menu at the top of the screen.

3D View

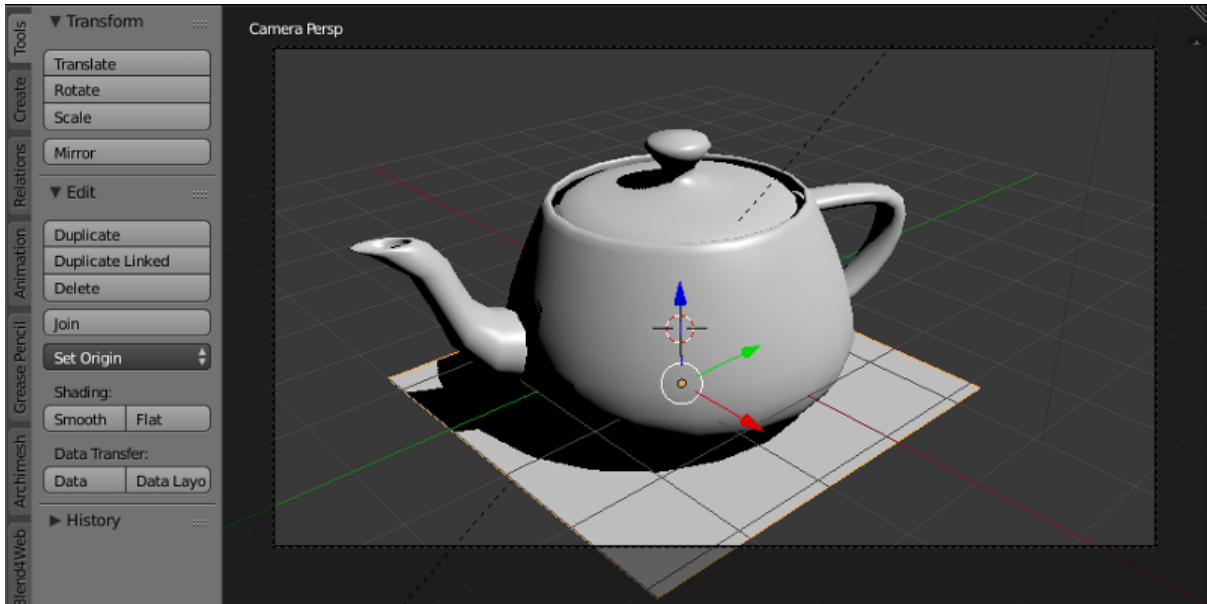

The main window of the program, showing a currently loaded 3D scene (through a camera or otherwise). 3D objects that compose any 3D scene are created, edited and animated in this window.

This window is open by default.

Timeline



This window (usually located on the bottom of the screen) shows various data that concern animation. This includes the current frame, the total number of frames (i.e. the length of the animation in the current scene) and keyframes for the selected object. The keyframes themselves are also created in this window.

This window is open by default.

Graph Editor

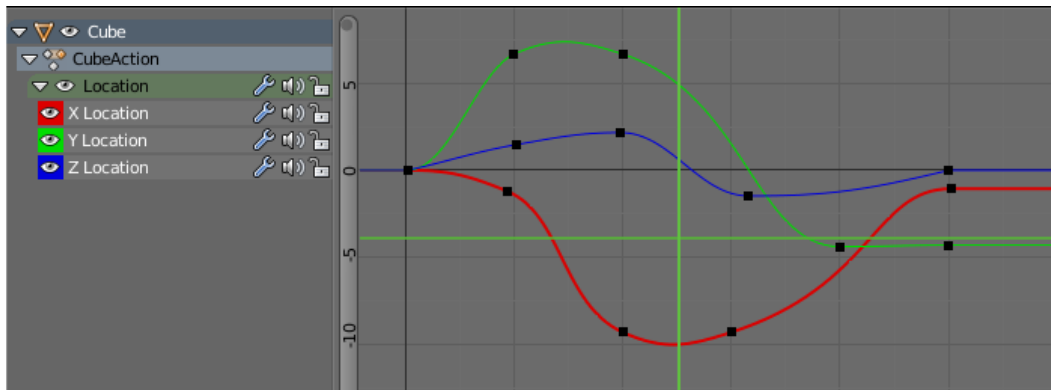

A tool for modifying various aspects of object animation using f-curves. Graph Editor can be used in Blend4Web same way it is used in Blender.

Dope Sheet

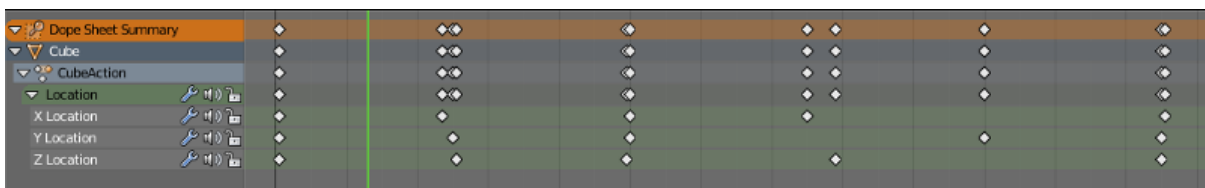

A tool for managing keyframes. Dope Sheet can be used in Blend4Web same way it is used in Blender.

NLA Editor



A tool for editing non-linear animations. Blend4Web engine supports NLAs; the user manual features a [dedicated section](#) on them.

UV/Image Editor

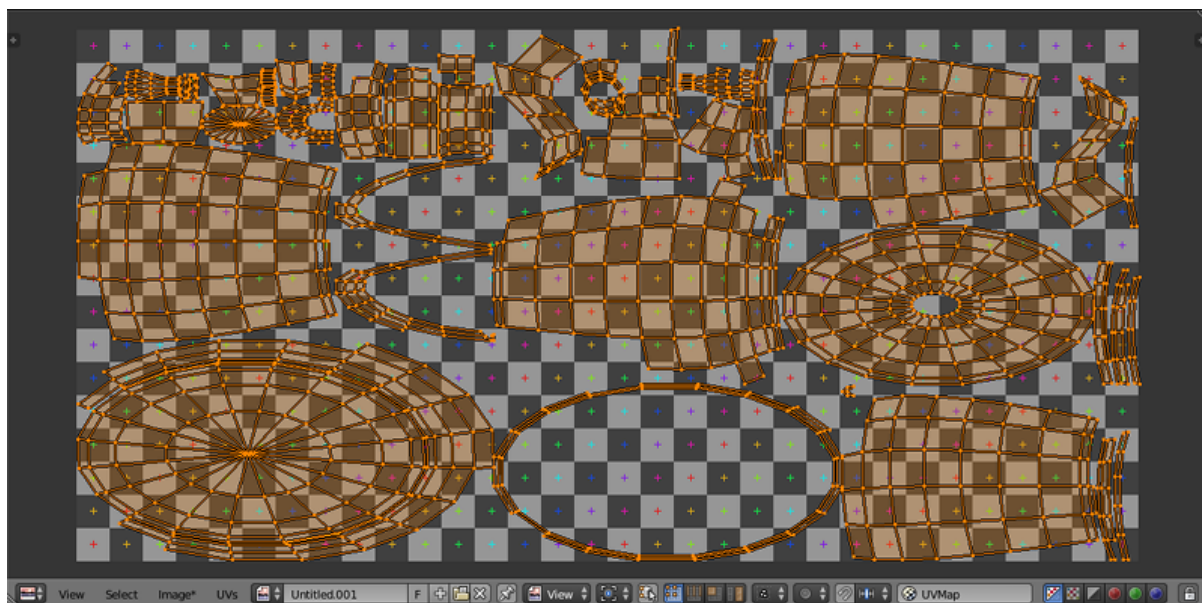

This tool can be used for editing both object UV maps and various 2D assets such as texture images.

UV maps are used in Blend4Web as well.

Video Sequence Editor

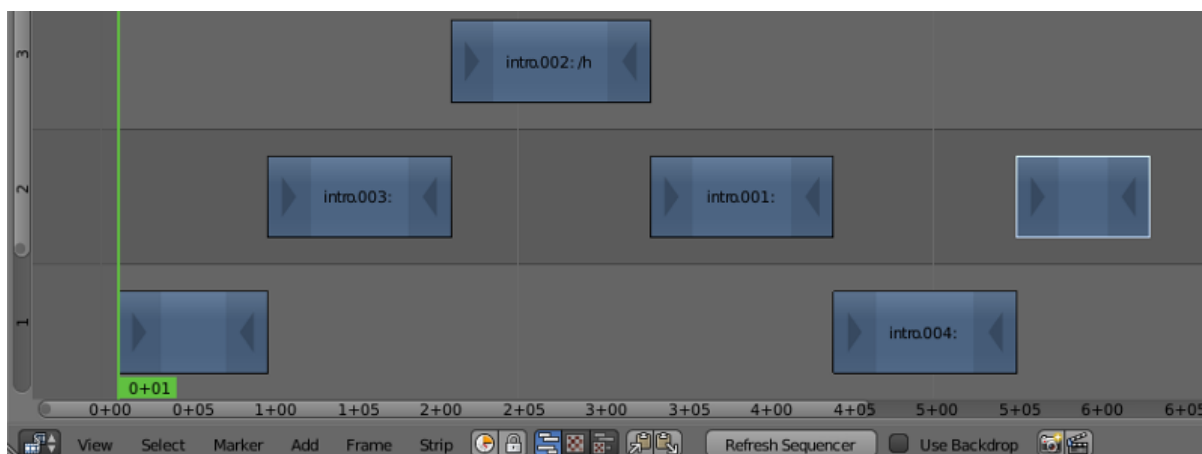

An interface for editing video sequences. This is a fully-fledged video editing system that can be used to trim video files, apply effects to them and combine them into one video. It is not used in Blend4Web engine.

Movie Clip Editor

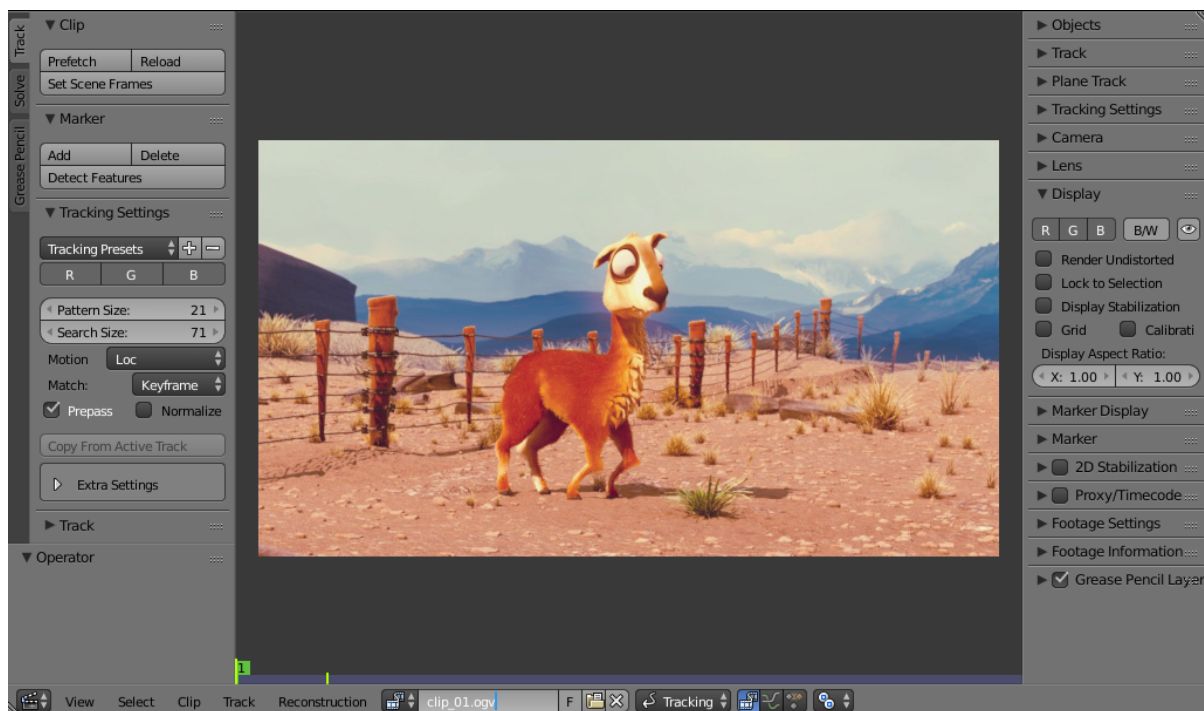

A tool for editing movie clips. It is generally used for motion tracking and for masking movies. It is not used in Blend4Web engine.

Text Editor

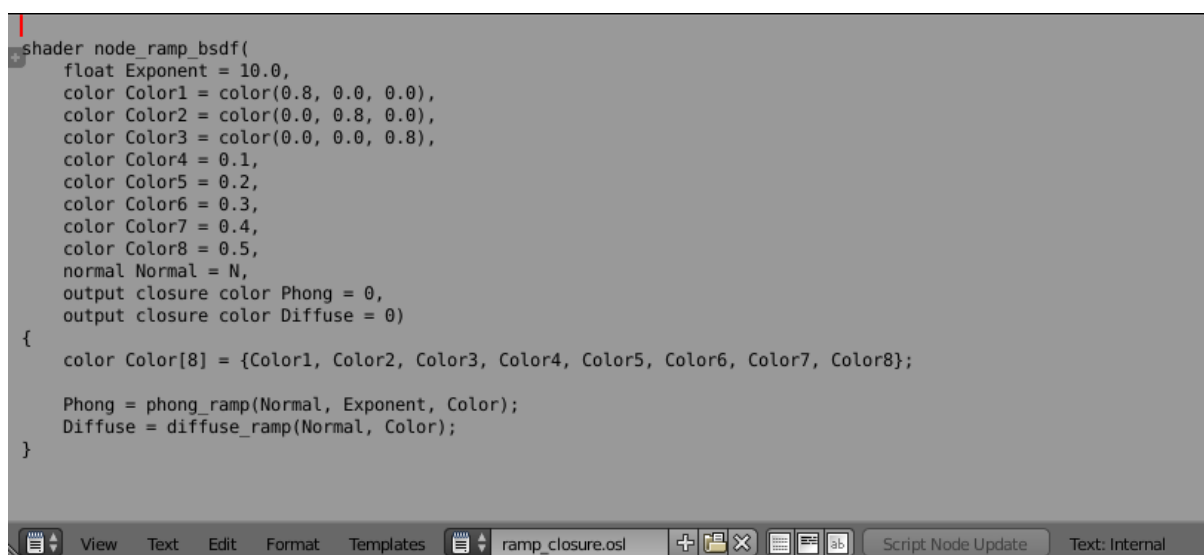

A simple text editor is included in Blender. It supports word wrapping, syntax highlighting, line numbers, find and replace functions and some other features.

Text editor is not used in Blend4Web for editing project files, as [Project Manager](#) features its own built-in editor for editing project files. However, text files created in Text Editor

(or imported to a .blend file using it) can be used as description sources for [Meta Tags](#) in Blend4Web.

Node Editor

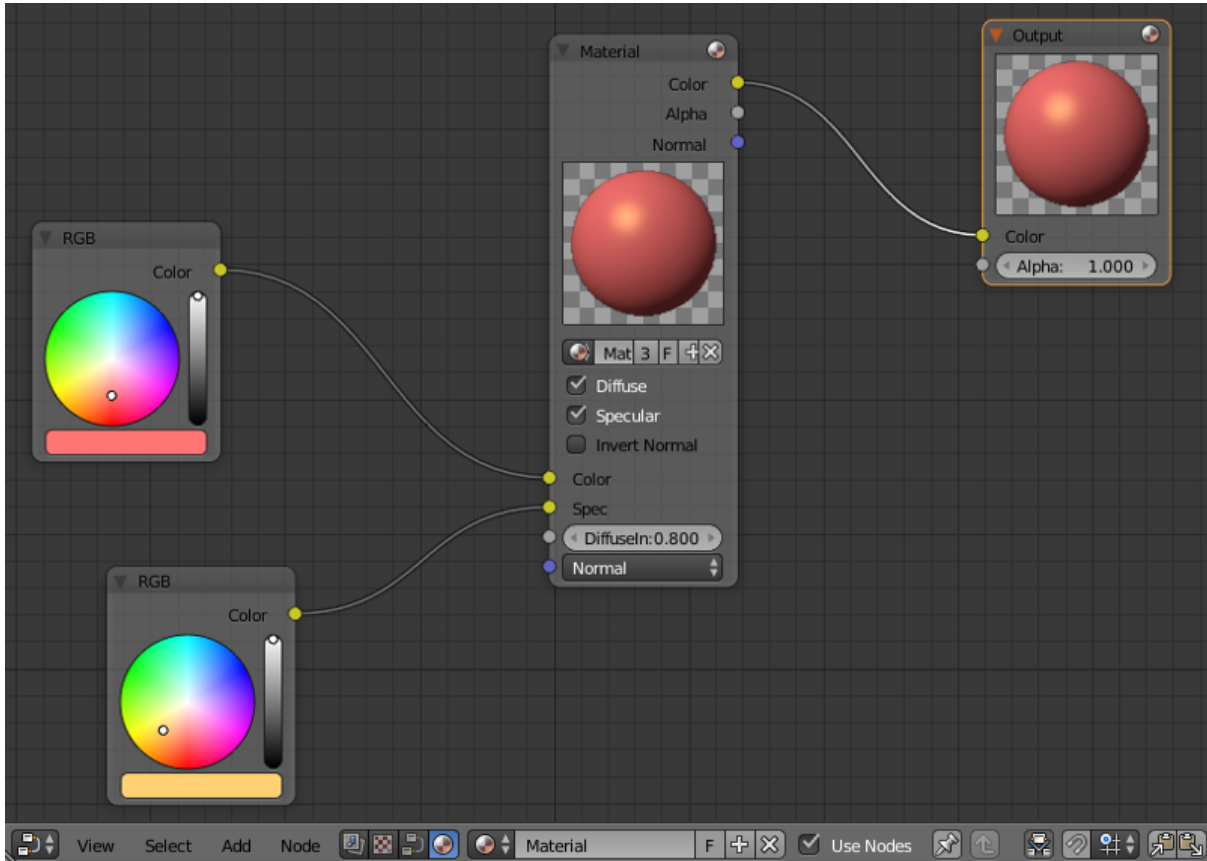

An interface for creating node-base materials, textures and post-processing effect. [Material nodes](#) are supported in Blend4Web engine, while texture and compositing nodes are not. Blend4Web also features another type of nodes for creating [scene logic](#).

Logic Editor

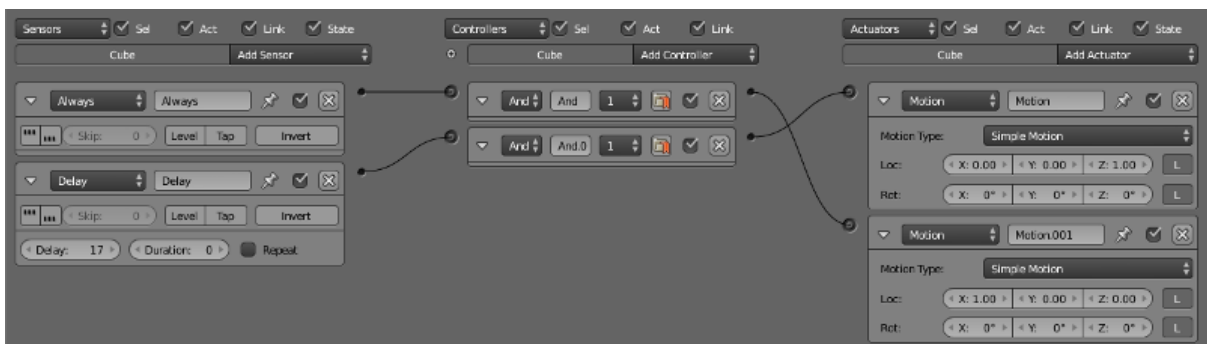

A tool for editing logic blocks used in Blender Game Engine.

Note: Blend4Web engine does not use Blender Logic Editor. Instead, it features a similar, but separate tool for editing scene logic: the node-based [Logic Editor](#).

Properties



The second main window of the program. Contains various settings, some of which only concern currently selected object, and other apply to the whole of the scene.

This window is usually located at the right of the 3D View window.

The Properties window consists of several tabs. Each one of these tabs house a specific group of parameters. The tabs are:

Render

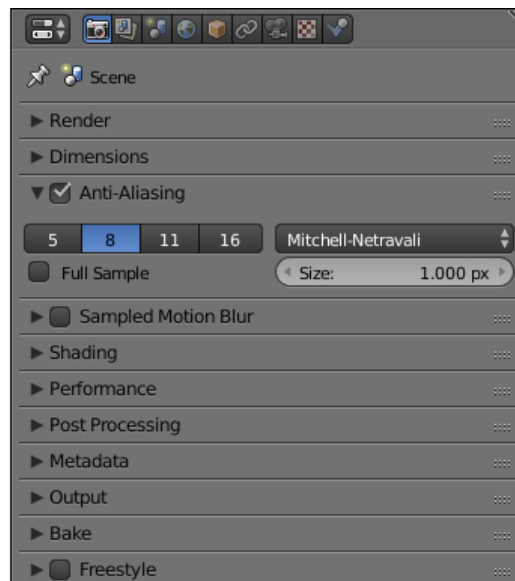

This tab contains options that concern rendering.

In Blend4Web mode, the Render tab features a slightly different set of options that are described [here](#).

Render Layers

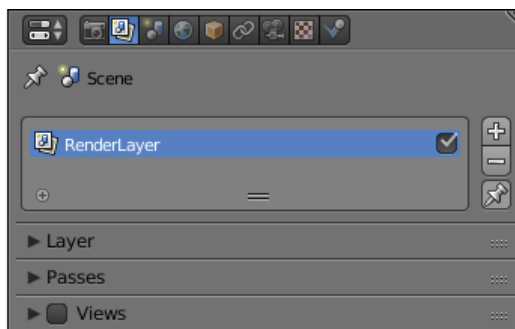

This tab can be used to separate the rendered image into several “layers” (such as diffuse colors, shadows, normal maps etc.) that can than be used for compositing in Blender or in other software. This tab is not used in Blend4Web engine.

Scene



Contains various parameters that concern 3D scene as a whole.

This tab is supported in Blend4Web, but has a different set of options that are described [here](#) in greater detail.

World

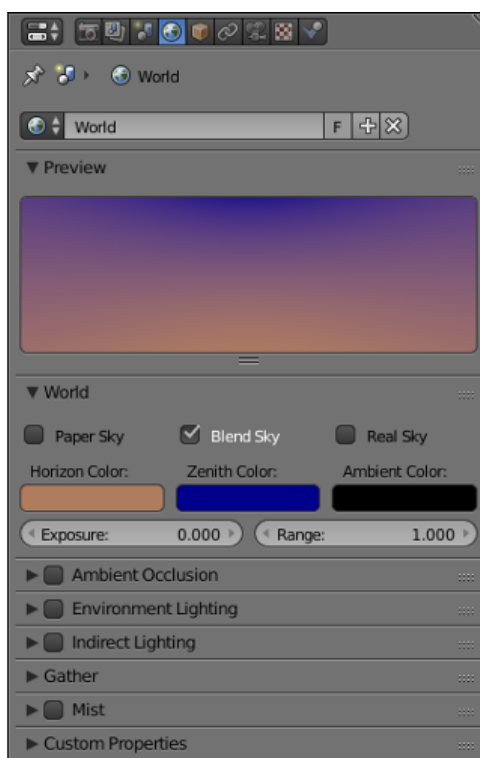

Settings that control the environment of the scene can be found in this tab. This includes such parameters as background colors, environment lighting, mist etc.

This tab is also used Blend4Web engine to set the environment. The settings themselves differ a bit from the ones in Blender. The differences are described [here](#).

Object

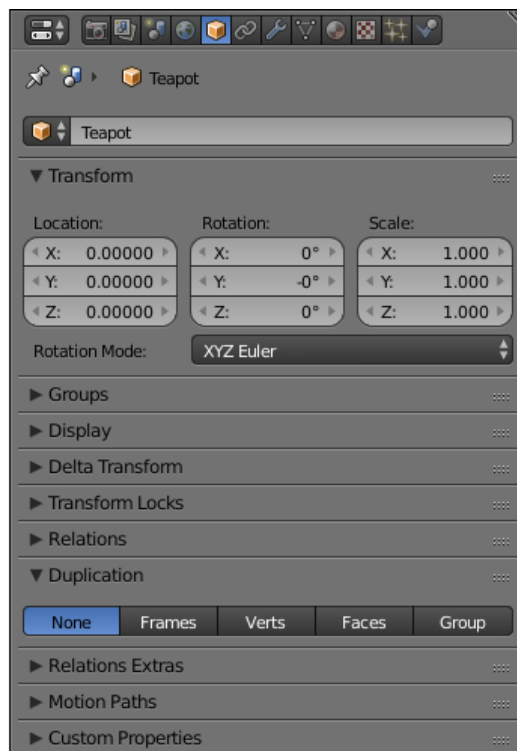

This tab contains various object settings such as name, location, groups and so on. Object parameters are extensively used in Blend4Web engine and are described in a [dedicated section](#) of this manual.

Constraints

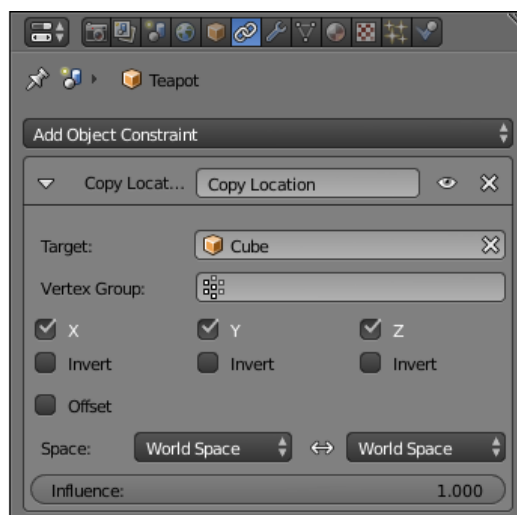

Constraints can be used to restrict object's movement in various ways, or to set it along a certain path. Constraints are often utilized by 3D artists to simplify the process of creating complex animations and to make it more convenient. This tab contains tools for adding constraints to a selected object, setting them up or remove them, if necessary.

The Constraints tab can be used in Blend4Web. However, at the moment the engine does not support some of the object constraints available in Blender. See the [dedicated section](#) to learn how to use object constraints in Blend4Web.

Modifiers

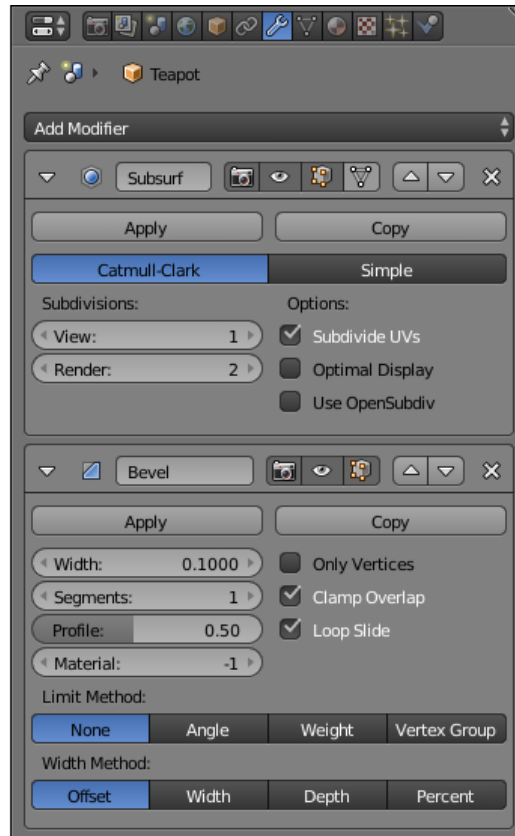

This list contains all modifiers attached to the currently selected object. Modifiers can be added, configured and removed on this tab.

Modifiers are supported in Blend4Web engine, but by default are not applied to objects upon export. You can apply modifiers using [Apply Modifiers](#) or [Apply Scale and Modifiers](#) options.

Data

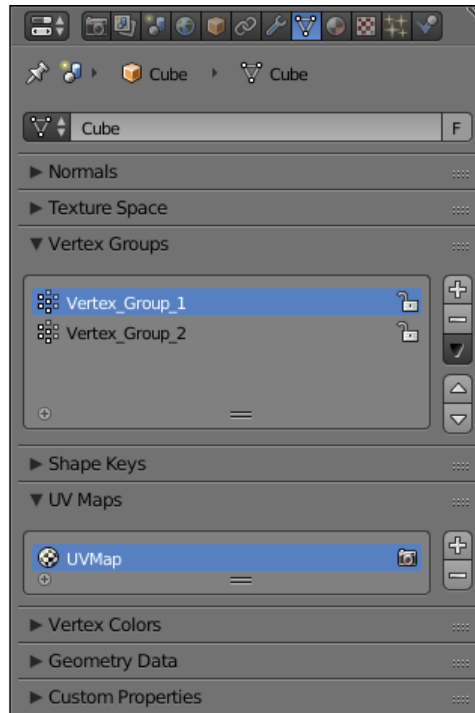

This tab contains information on object's vertex groups and colors, UV maps, shape keys and other similar stuff. It is supported in Blend4Web and does not feature any additional options.

Material

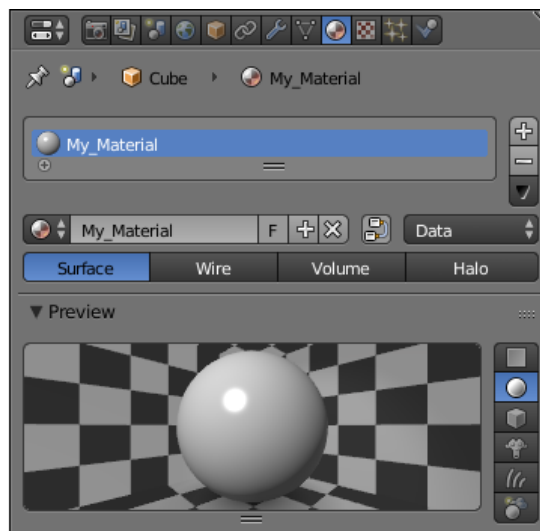

The material (or multiple materials) of an object can be set here.

Blend4Web engine utilizes materials in mostly the same way Blender does. The differences are described in a [dedicated chapter](#).

Texture

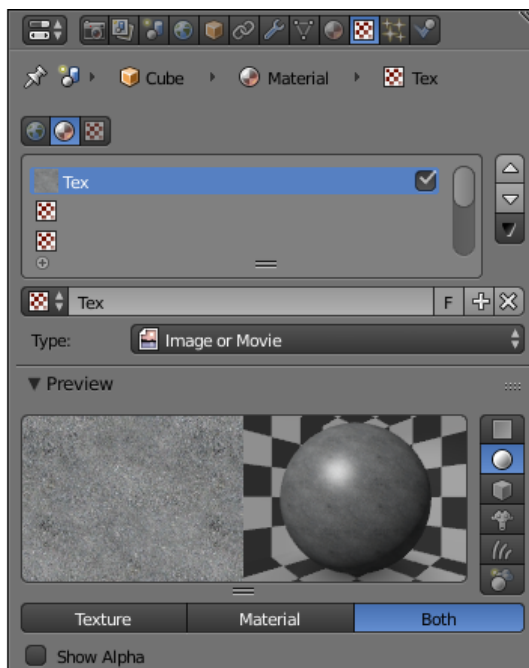

This tab is intended for setting up textures for materials and the environment alike.

The same tab is used to set up textures in Blend4Web. Working with textures is described in a [dedicated chapter](#).

Particles



Here, particle systems are created and set up.

Particles are supported in Blend4Web engine as well and can be used to create fluids and object instances.

Physics

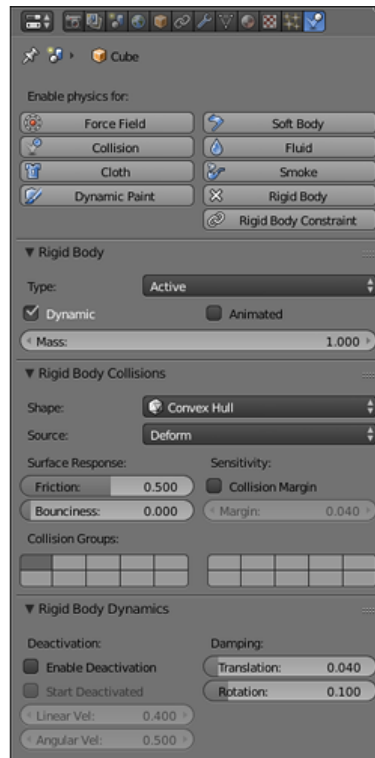

Physical settings of a selected object: a physical model associated with an object, its bounding volume and so on. Physics is utilized in Blend4Web engine and has an [entire chapter](#) dedicated to it.

Outliner



Contains so-called scene graph, a tree-like structure that organizes all data present in the .blend file.

By default, this window is located in the top right corner of the Blender window.

User Preferences

This window contains various Blender settings. These settings are separated into several categories each one of which occupies one tab located at the top of the window. The tabs are:

Interface

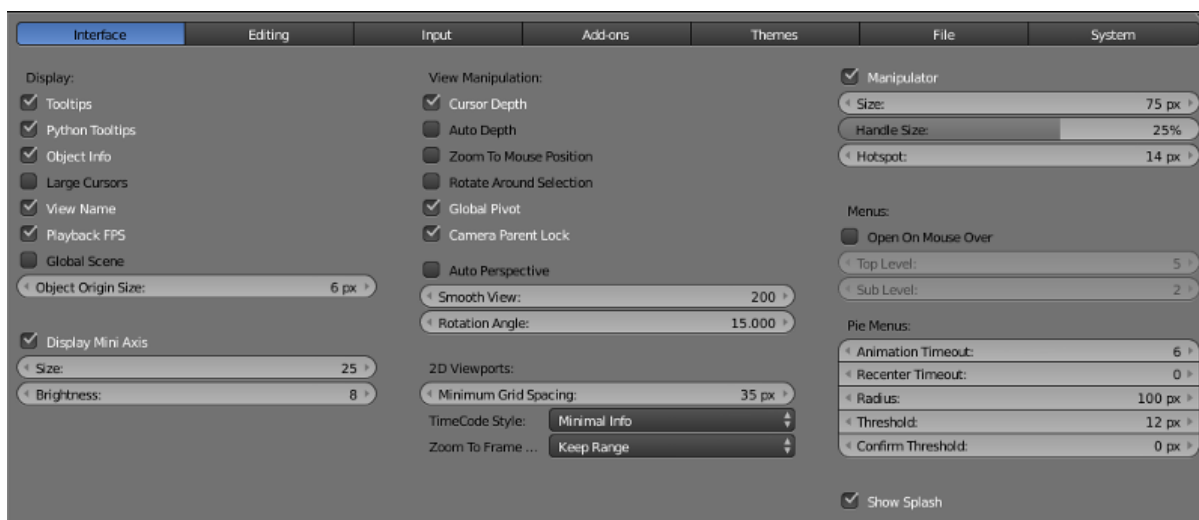

This tab contains various setting for adjusting the interface of the program.

Editing



This tab allows you to set how various object editing tools interact with your input.

Input

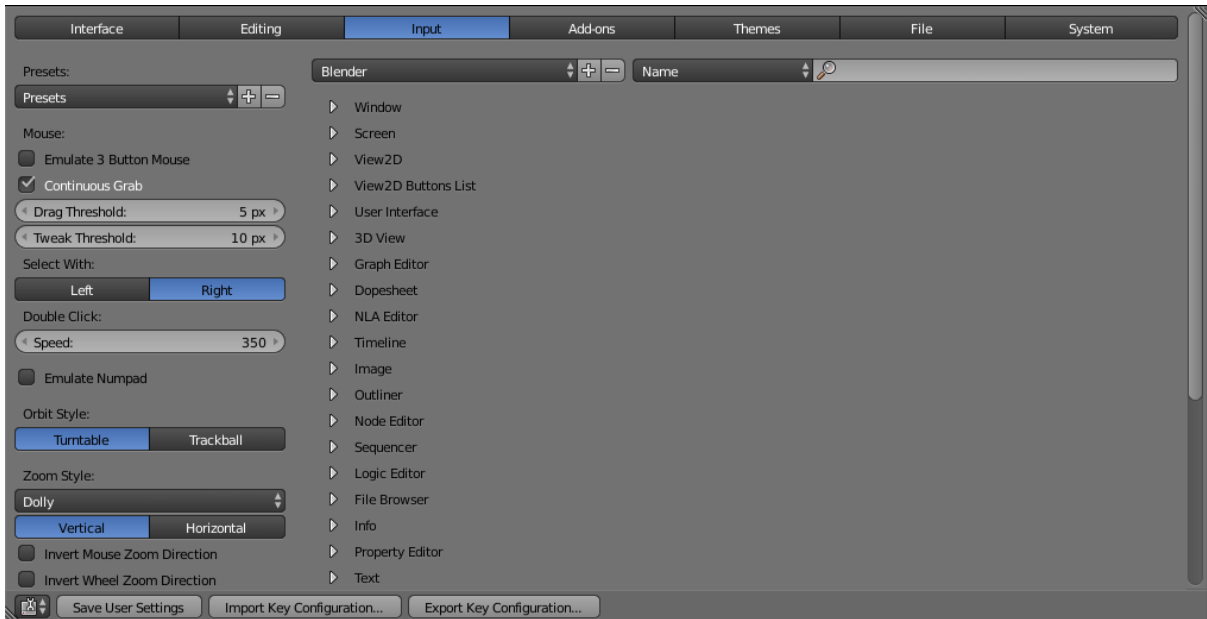

User-interaction settings. Hot keys are set here, as are the way Blender reacts to mouse and keyboard events.

Add-ons



Various Blender add-ons are installed, configured and removed here. This includes Blender4Web add-on.

Themes

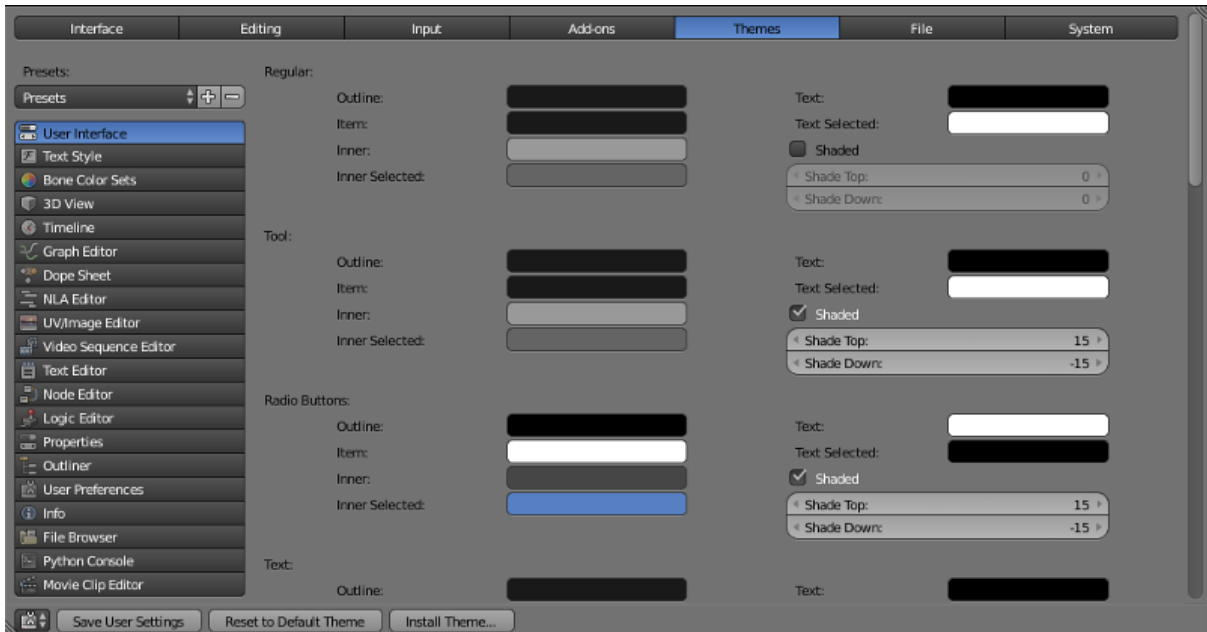

This tab allows the user to customize Blender interface and color scheme, both manually or by selecting one of the pre-existing interface themes.

File

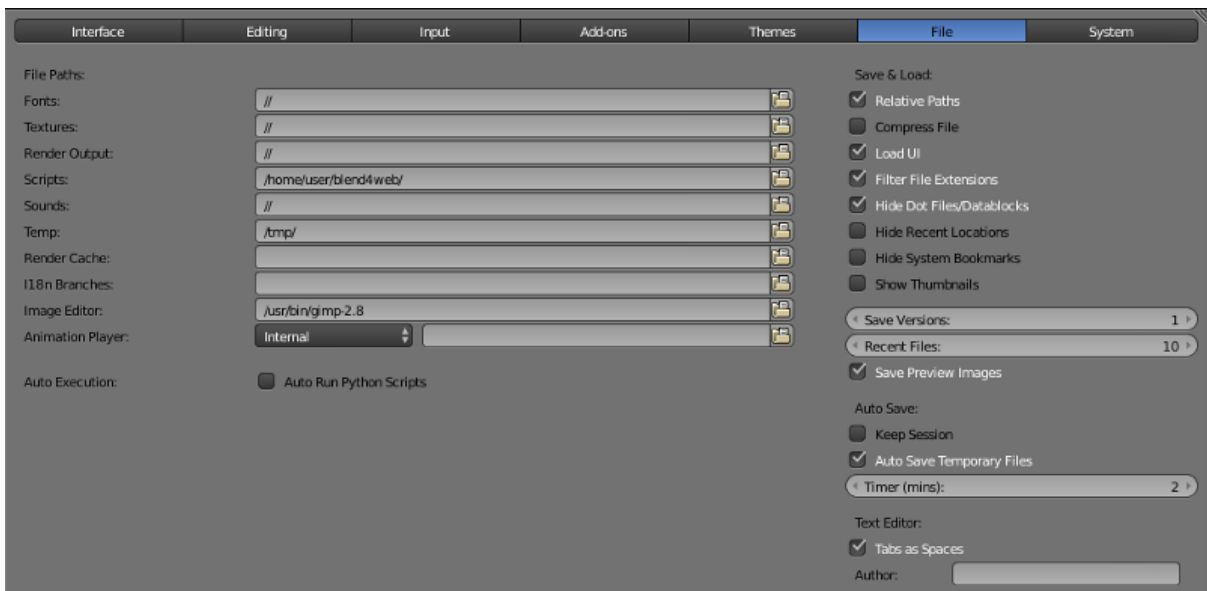

This tab is used to configure default file path for blend files, textures, rendered images and other files. Auto-save preferences are also set up here.

The Scripts field on this tab is used for installing Blend4Web engine. The process of installation is thoroughly described in the [dedicated chapter](#).

System

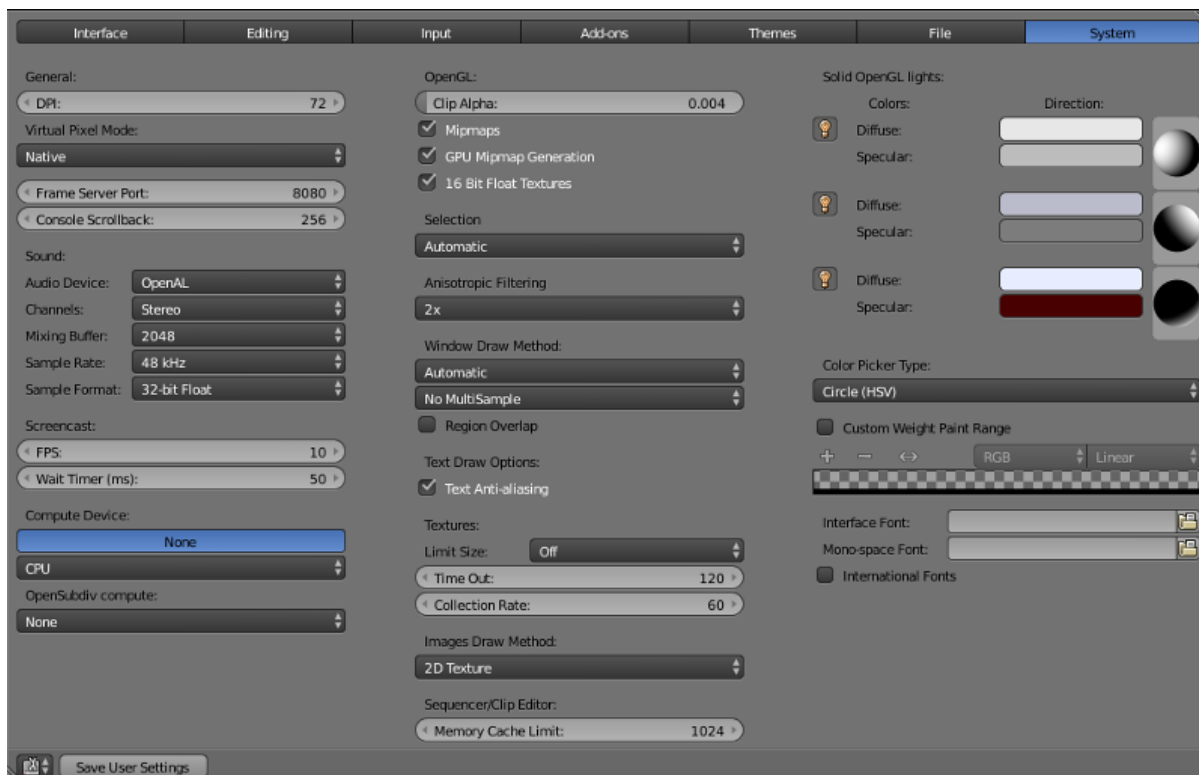

Various system settings, including resolution, rendering device, viewport settings and interface language.

Info

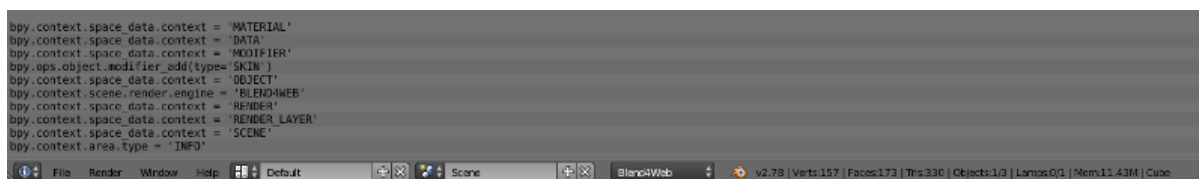

The main menu bar with a list of error messages. This window is open by default and can be found at the top of the screen (right above the 3D View window).

Note: The list of errors is folded by default.

Tip: You can expand it by dragging the border of the Info window down.

File Browser

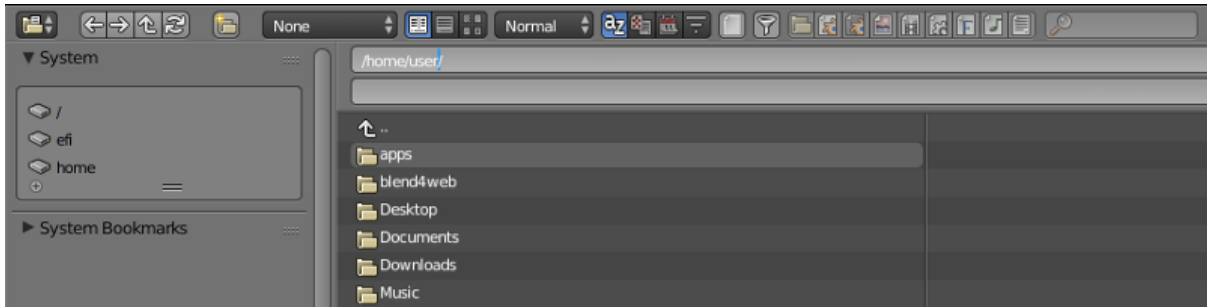

This is a built-in file manager that can be used for various file-related operations, mostly opening/saving .blend files and importing/exporting scenes and assets.

Python Console

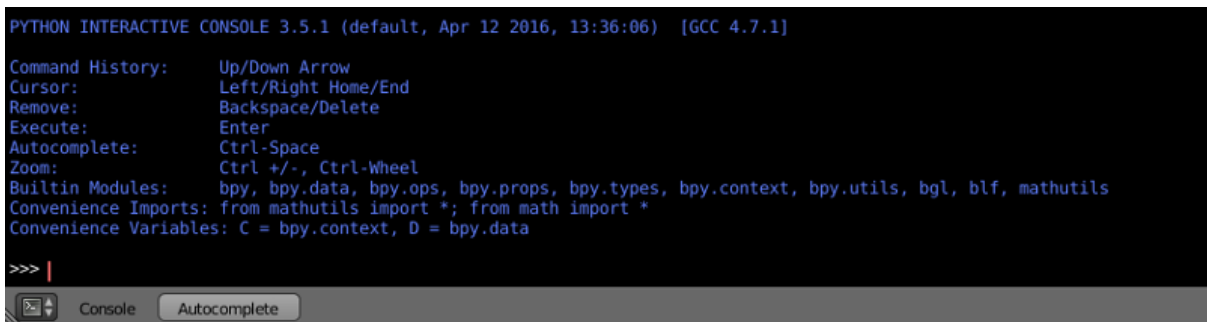

This is a tool intended for an experienced user. The Python Console offers a quick way to execute commands, complete with auto-complete feature, a command history and full access to the entire Python API.

Installing and Updating

Table of Contents

- Installing and Updating
 - Installation
 - * Installing Blender
 - * Installing Blend4Web SDK
 - * Installing Blend4Web Add-On
 - * Switching to Blend4Web Mode
 - Updating
 - * Updating the SDK
 - * Updating the Addon
 - * Updating Saved Projects

Installation

There are two versions of the Blend4Web framework: Blend4Web SDK and Blend4Web Add-On. In order to decide which one best suits your needs, you will need to decide which kinds of applications you are planning on developing.

If you plan on using all features that Blend4Web engine has to offer, you should install Blend4Web SDK.

If your intention is to develop small-scale projects, or if you are planning on using only a limited number of features of the Blend4Web engine (the normal editor, for example), you might consider installing the [Blend4Web Add-On](#) instead.

Note, the Add-On can only export scenes to [HTML format](#) and has limited functionality. For example, it does not include the [project manager](#), example scenes, user manual and other additional resources. However, it still has everything you might need to create a simple application.

Installing Blender

Authoring 3D scenes is carried out directly in **Blender** which is open source software and is distributed free of charge.

Before installation, please download and install the compatible Blender version, according to [this table](#).

A current stable version of Blender should be used. It can be downloaded from the [official site](#) or from [Blender4Web site](#).



Installing Blender4Web SDK

Stable versions of the distribution are available as an archive (blend4web_ce_YY_MM.zip – free SDK, blend4web_pro_YY_MM.zip – commercial SDK). Simply unpack this archive somewhere.

1. Run Blender.
2. Open the User Preferences panel File > User Preferences....
3. Open the File tab.
4. Set the path to the SDK directory in the Scripts field.
5. Click the Save User Settings button.

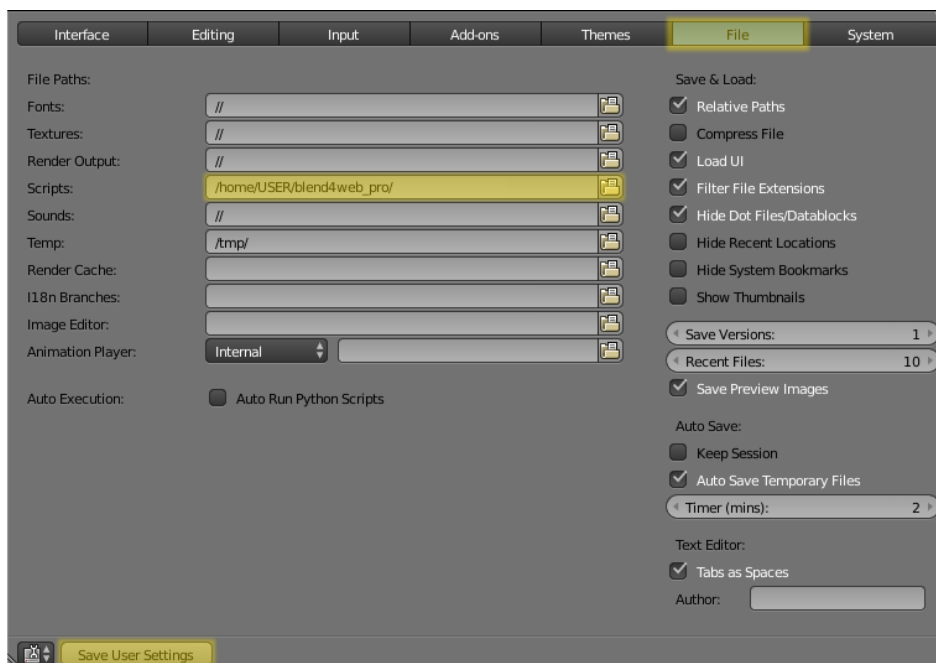

6. Restart Blender.
7. Once again, open the User Preferences panel File > User Preferences....
8. Open the Add-ons tab.
9. Enable the Blend4Web add-on.
10. Once again, click the Save User Settings button.

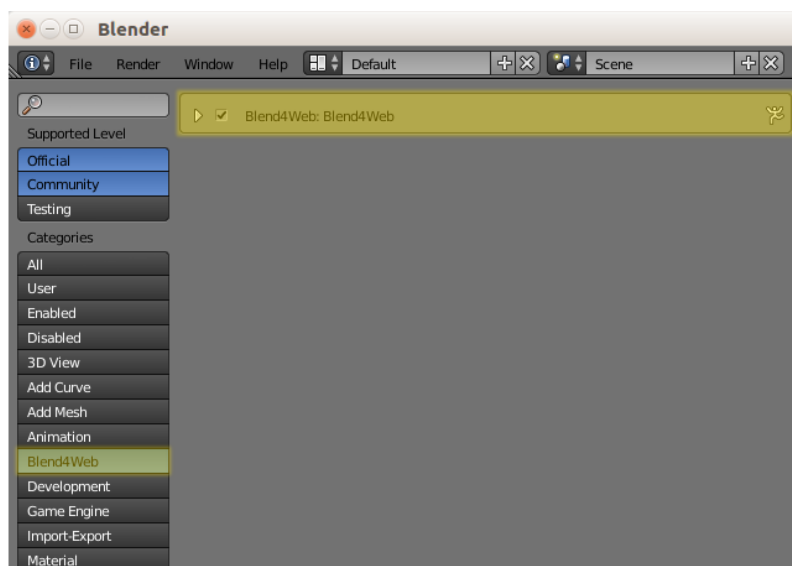

To verify it worked:

In the File > Export menu, the Blend4Web (.json) and Blend4Web (.html) options should appear.

Installing Blend4Web Add-On

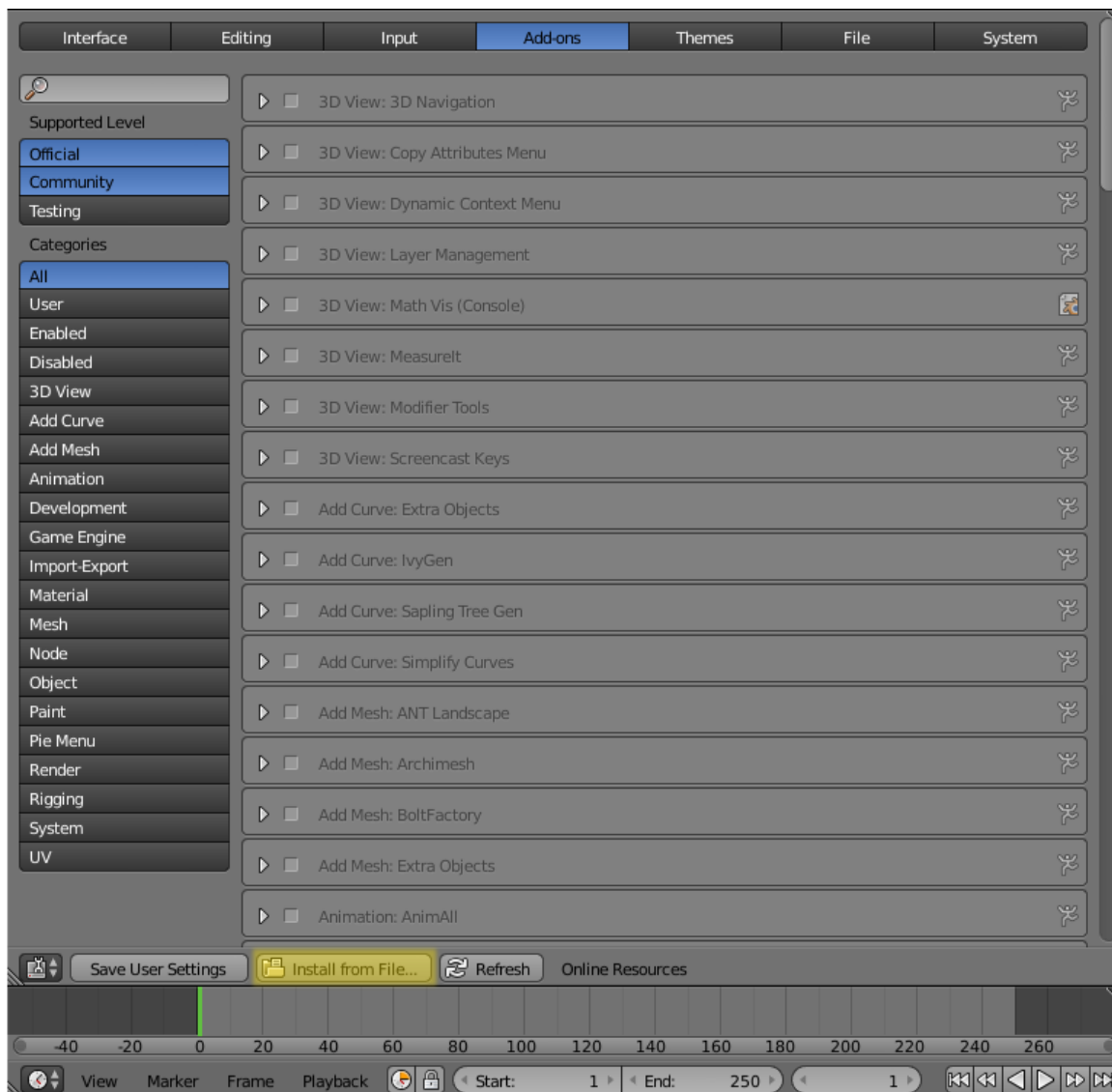

It can be installed the same way as any other [Blender](#) add-on.

1. Run Blender.
2. Open the User Preferences panel `File > User Preferences....`
3. Open the Add-ons tab.
4. Press the Install From File... button.
5. Select the archive containing Blend4Web add-on and press Install From File... button.
6. Press the Save User Settings button.
7. Restart Blender.
8. Once again, open the User Preferences panel `File > User Preferences....`
9. Open the Add-ons tab.

10. Find the Blend4Web Add-on in the list.
11. Check the box on the left side of its title to enable it.
12. Press the Save User Settings button once again.

Now, everything should work properly.

Switching to Blend4Web Mode

To reveal the engine settings, select Blend4Web from the upper panel menu:

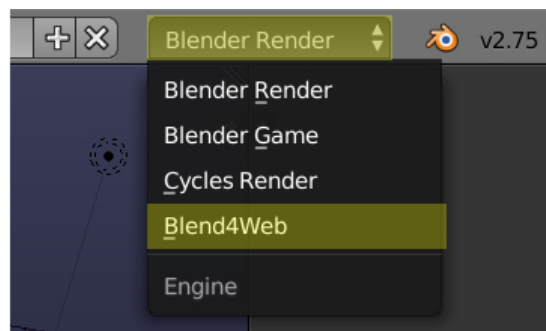

Updating

Updating the SDK

Before updating, we recommend to backup all projects in development using the [project export](#) tools.

To update the SDK, follow these steps:

1. Download the new version of the SDK.
2. Run Blender.
3. Open the User Preferences window.
4. Open the Add-ons panel.
5. Disable Blend4Web Add-on.

Note: We recommend not to use the Remove button to disable the Add-on for updating the SDK, as doing so will completely delete the add-on, including its files in the SDK.

6. Unpack the new version of the SDK from the archive.

Note: There are two methods to do this.

Firstly, you can completely delete the SDK folder and, after that, extract the new version folder, as if you were installing the SDK for the first time.

Secondly, you can simply overwrite the outdated SDK files with the new ones. This method is considered less “pure”, but in most cases it should not cause any problems.

7. Open the File panel in the User Preferences window.
8. Set the path to the SDK folder in the Scripts field.
9. Press the Save User Settings button.
10. Restart Blender.
11. Open the User Preferences window once again.
12. Open the Add-ons panel.
13. Enable Blend4Web add-on.
14. Press the Save User Settings button once again.
15. Check if everything works correctly.

After updating is complete, you can import all saved projects using the [project import](#) tools.

Updating the Addon

If you are only using the Blend4Web add-on, follow this instruction instead.

Before installing a new version of the add-on, you may firstly remove the existing one. To do this, unfold the information tab of the Blend4Web addon and press the Remove button. Removing the old version is not required before installing a new one, but doing so makes sure there won't be any conflicts.

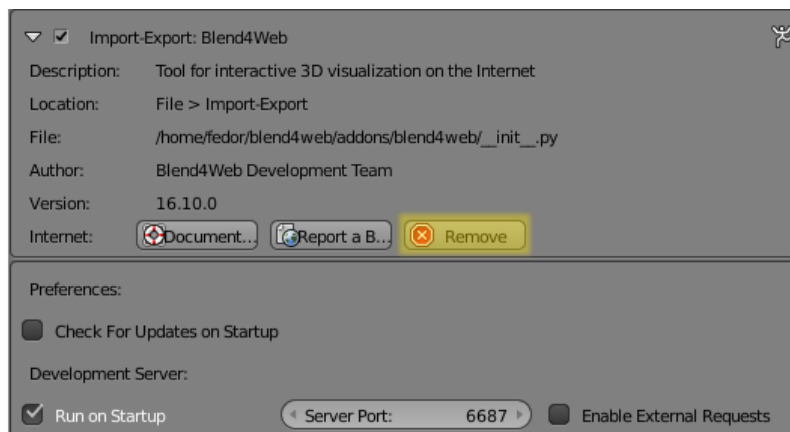

1. Download the archive that contains the new version of the add-on, and save it to any place on your hard drive.
2. Run Blender.
3. Open the User Preferences window.
4. Switch to the Add-ons panel.
5. Install the new version of the add-on from the archive you downloaded.
6. Press the Save User Settings button.
7. Restart Blender.

Everything should be working now.

Updating Saved Projects

After you have updated your SDK (or Add-on), you can import projects that you exported before updating back to the Project Manager. To do this, follow the following instructions:

1. Open Project Manager.
2. Import your projects using the Import Project(s) button.
3. Reexport the projects' .blend files using the re-export scenes link.
4. Use the check modules link for every imported project to make sure there are no missing or unused modules in the program code. If there are, you may try to fix the problems using the Update Modules button.
5. Then use build command to make the build versions of the imported projects work again.
6. The developer version of the projects using Copy or Compile engine binding type should also be build to properly work with the new version of the SDK (the developer versions of the projects with other binding types should work fine without it).

Workflow

Table of Contents

- Workflow
 - Creating a New Project
 - Creating Scenes
 - Preparing a Scene to Use in Blend4Web
 - * Displaying Scenes in the Viewer
 - Exporting Scenes
 - Application Development
 - Project Building
 - Project Deploying

Developing any product is a creative process with many participants who have different skills and experience. However, no matter how complex it is and what is the target it's always possible to separate the production stage in which the bulk of assets and source code is authored.

Any work with the Blend4Web engine should start with running Blender.

Select Blend4Web from the render engine list at the top panel in the main Blender window, and you will see how the program interface have changed. Some parameters will disappear, and new ones will take their place. The most important of these new parameters are located in the Properties window (usually placed at the right side of the main window), on the Render panel.

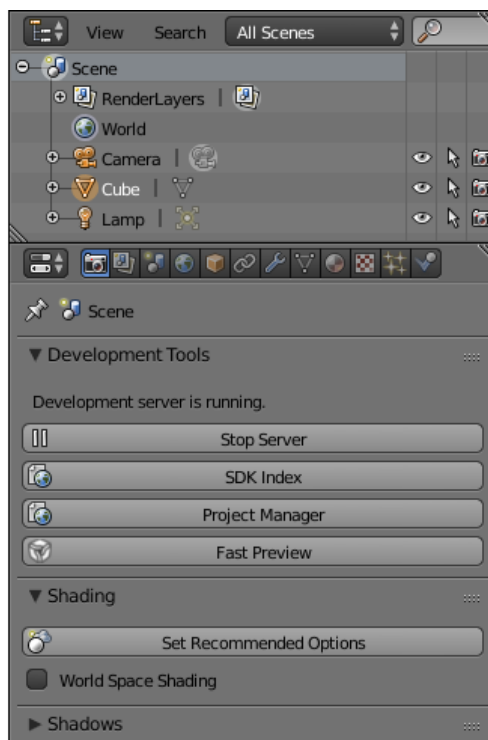

Note: If the Development Tools tab shows the Development server is off message, this means that the development server is not working. It can be enabled with the Start Server button on the same panel. The server can also be configured to run on startup with the Run On Startup option found in the add-on settings (User Preferences → Add-Ons → Blend4Web).

If any problems occur as you try to run development server, please consult the [Problems and Solutions](#) chapter.

The SDK Index button opens the [index page](http://localhost:6687) that can be found by this address: <http://localhost:6687>.

The Fast Preview button opens the [Scene Viewer](#) and loads the scene that is open in Blender at the moment. This is a useful feature for planning and debugging your scenes.

The Project Manager button opens the [Project Manager](#) — a powerful and easy to use tool for working with Blend4Web projects. Using Project Manager is the most simple way to start working with Blend4Web.

When using Blend4Web the workflow is the following:

1. Creating a New Project.
2. Creating Scenes
3. Preparing a Scene to Use in Blend4Web
4. Exporting scenes.
5. Application Development.
6. Project Building.

7. Project Deploying.

Creating a New Project

The work on a project, of course, should always start with creating it.

The easiest way to create a new project is to use the [Project Manager](#). To do it, run the Project Manager (either from Blender or from index page) and press the Create New Project button at the top of the Project Manager's main window.

The other way is to use the `project.py` command line script, which is more versatile. Working with this script is described [here](#).

Creating Scenes

Scenes are contained in blend files. Project Manager can automatically create a blend file with a basic scene upon creating a new project. Additional blend files can be created and attached to a project.

Scenes for Blend4Web are created in the same manner as the scenes for Blender itself, with only minor differences. The process of working on a scene could be separated into several stages:

1. Modeling the scene objects
2. [Setting up materials](#)
3. [Animating objects](#)
4. [Creating scene logic](#) (this part is exclusive for Blend4Web engine and does not apply to regular Blender scenes)

It should be noted that not every project may require all of these stages. More simple scene might not feature any animations or even any materials aside from the default ones.

The order of the stages is also not strict and can be interchanged to a certain degree (for example, you won't probably animate an object before creating it, but you can create a material for it beforehand).

Besides the usual stages such as modeling, texturing, animation etc a scene should be prepared for working in the engine.

General recommendations:

1. We strongly recommend to save your blend files in the `projects/project_name/blender` directory. Auxiliary files which are not intended for loading in your app (for example, references), should be located there as well.
2. Images and media files should be external and located in the `projects/project_name/assets` directory.

- Files from which you export should contain resources which are actually required in your application (objects, materials, textures, animation etc).
- Scene components should have distinct names. They should not be named “Cube.001”, “Material” or “Armature”.
- We recommend you to link components from other files (libraries).

Preparing a Scene to Use in Blend4Web

Besides the usual stages such as modeling, texturing, animation etc a scene should be prepared for working in the engine.

Displaying Scenes in the Viewer

When using the [local development server](#) it's possible to preview current scene using [Fast Preview](#) button located at the bottom of Blender's 3D View window, and also on the [Render -> Development Server](#) panel in Blender. In this case the scene will be exported inside some temporary storage and loaded in the Viewer app.

The other method is using [Run in Viewer](#) export option. In this case the scene will be displayed in the Viewer app immediately after the export.

Exporting Scenes

The export procedure converts the scene from the Blender format to one of the formats used by Blend4Web.

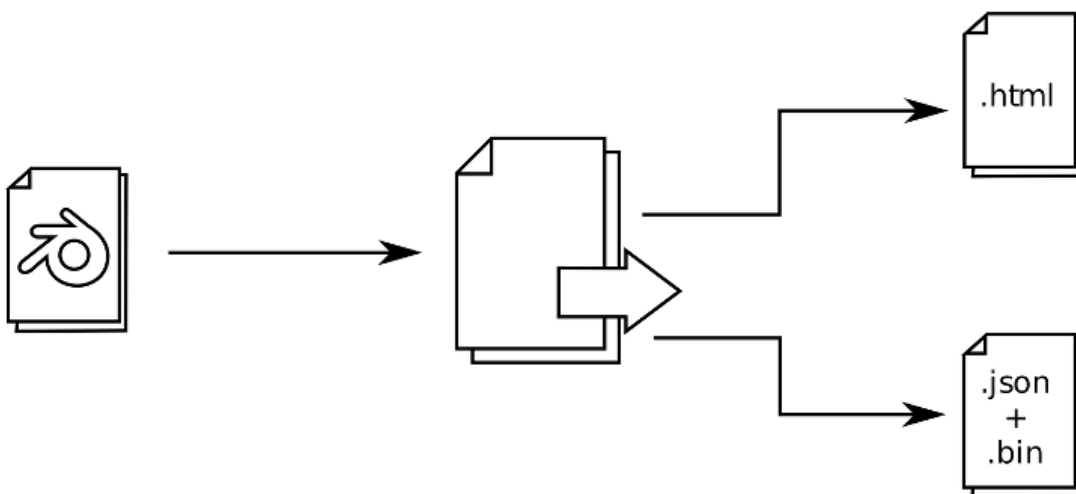

There are two formats: JSON and HTML.

The HTML format is used for simple stand-alone applications, where all the resources are packed into one HTML file that can then be easily deployed to a web page.

The JSON format can be used for creating such projects as well, but it also offers numerous extra features making it possible to create complex projects that require programming. Format differences and export options are described in the [Export Formats](#) chapter.

To export the scene, select Blend4Web (.json) or Blend4Web (.html) option from the File > Export menu, or type b4w export in the operator search menu (available by pressing Spacebar).

Note: If the scene uses Blender features not yet supported by the Blend4Web engine, errors may occur during export. Export errors are listed in [this table](#).

Export options are described in detail in the [corresponding section](#).

Application Development

This section only applies to the project types other than Web Player HTML and Web Player JSON.

At this stage an application is created. Logic for scene loading and user interaction is written using JavaScript. The application developer notes are given in the [corresponding section](#).

Project Building

After development of a project is completed, it should be built so it can then be used outside of the SDK.

Project building can be performed by clicking the build project link in the [Project Manager](#).

Before building a project, you might want to [convert media resources](#) used in the project, which can help to minimize its size.

Project Deploying

After project development is completed, the project can be deployed so it can be used outside of the Blend4Web SDK. Project deployment is performed by clicking the deploy project link that can be found in the Operations command list on the right side of the project entry in the main window of the [Project Manager](#).

Clicking this link will cause Project Manager to perform all necessary operations and to deploy the project.

The deployed project has a form of an archive that contains all project files. This archive can be saved to any place on your disc with the use of a standard Save File dialogue in the web browser you are using.

A complete project can be placed on a web server.

To do it, extract the project files from the archive downloaded from the Project Manager and upload them to your web server (while retaining inner file structure) by means of FTP, SSH or any other file transfer protocol supported by the server. After doing this, you only need to place the project on a web page using, for example, an iframe container.

Deploying project to web server is described in a [dedicated section](#) of the [Project Manager](#) chapter.

Project Management

Table of Contents

- Project Management
 - Project Manager
 - * Project Creation Wizard
 - * Creating a Web Player Application
 - * Project Information
 - * Project Editing
 - * Project Config
 - * Project Import
 - * Project Export
 - * Deploying the Project
 - Advanced Project Management
 - * Dependencies
 - * Projects List
 - * Project Structure
 - * Project Configuration File (.b4w_project)
 - * Creating a Project
 - * Developing multiple apps inside a project
 - * Building Projects
 - * Automatic Blend File Export
 - * Resource Conversion
 - * Deploying Projects
 - * Remove Project
 - * Upgrading Apps for New SDK Versions

Since version 15.09, the SDK includes a project management feature, which makes it possible to:

- browse the full list and file structure of the projects;
- launch apps, run exported scenes in the Viewer, open source blend files in Blender;
- create and configure new apps, including those based on ready-made templates;
- build apps and pack them to be conveniently deployed on a remote server;











- convert app resources (textures, audio and video files) into alternative formats to ensure cross-browser and cross-platform performance;
- automatically re-export all scenes of an app, including export to JSON and HTML formats;
- remove projects.

Project Manager

The Project Manager app can be run from the Tools section of the SDK's index page. Upon launching, the app outputs a list of all current projects in the SDK.

Project Manager

[Back to Index](#)
[Create New Project](#)
[Import Project\(s\)](#)
[Export Project\(s\)](#)
[Hide Stock Projects](#)
[Help](#)

Icon	Project Name / Apps	Project Directory / Build Directory	Blend Files	JSON Files	Operations
	boat_p28 (view) (edit) (config) player: boat_p28.json	blender/capri/vehicles/boat_p28	blender/capri/vehicles/boat_p28 (view)	deploy/assets/capri/vehicles/boat_p28/ (view) boat_p28.json	re-export scenes convert resources deploy project remove project
	capri (view) (edit) (config) dev: capri.html build: capri.html	apps_dev/capri deploy/apps/capri	blender/capri/ (view)	deploy/assets/capri/ (view)	build project check modules re-export scenes convert resources deploy project remove project
	car_bv_eb164 (view) (edit) (config) player: car_bv_eb164.json	blender/capri/vehicles/car_bv_eb164	blender/capri/vehicles/car_bv_eb164 (view)	deploy/assets/capri/vehicles/car_bv_eb164/ (view) car_bv_eb164.json	re-export scenes convert resources deploy project remove project
	demos_postprocessing (view) (edit) (config) player: bloom.json player: dof.json player: god_rays.json player: motion_blur.json player: ssao.json	apps_dev/demos_postprocessing deploy/assets/postprocessing	blender/postprocessing/ (view)	deploy/assets/postprocessing/ (view)	re-export scenes convert resources deploy project remove project
	farm (view) (edit) (config) dev: farm.html build: farm.html	apps_dev/farm deploy/apps/farm	blender/location_agriculture/ (view)	deploy/assets/location_agriculture/ (view) export/location_agriculture.json	build project check modules re-export scenes convert resources deploy project remove project
	firstperson (view) (edit) (config) dev: firstperson.html build: firstperson.html	apps_dev/tutorials/firstperson deploy/apps/tutorials/firstperson	blender/tutorials/firstperson/ (view)	deploy/assets/tutorials/firstperson/ (view) firstperson.json	build project check modules re-export scenes convert resources deploy project remove project
	mi_34c1 (view) (edit) (config) player: mi_34c1.json player: mi_34c1_demo_scene.json	blender/capri/vehicles/mi_34c1	blender/capri/vehicles/mi_34c1 (view)	deploy/assets/capri/vehicles/mi_34c1/ (view) mi_34c1.json mi_34c1_demo_scene.json	re-export scenes convert resources deploy project remove project
	naturemorte (view) (edit) (config) player: naturmort.json	blender/fridge blender/fridge/naturmort	blender/fridge/naturmort/ (view) naturmort.blend	deploy/assets/fridge/naturmort/ (view) naturmort.json	re-export scenes convert resources deploy project remove project
	petigors_tale (view) (edit) (config) dev: petigors_tale.html dev: quest.html build: petigors_tale.html build: quest.html	apps_dev/petigors_tale deploy/apps/petigors_tale	blender/petigors_tale/ (view)	deploy/assets/petigors_tale/ (view)	build project check modules re-export scenes convert resources deploy project remove project
	space_disaster (view) (edit) (config) dev: space_disaster.html build: space_disaster.html	apps_dev/space_disaster deploy/apps/space_disaster	blender/space_disaster/ (view)	deploy/assets/space_disaster/ (view) space_disaster.json	build project check modules re-export scenes convert resources deploy project remove project
	watch_scene (view) (edit) (config) player: watch_scene.json	blender/capri/props/watch_scene	blender/capri/props/watch_scene (view)	deploy/assets/capri/props/watch_scene/ (view) watch_scene.json	re-export scenes convert resources deploy project remove project

The commands for project management are located at the top of the page.

Project Manager

Back to Index	Create New Project	Import Project(s)	Export Project(s)	Hide Stock Projects	Help
-------------------------------	------------------------------------	-----------------------------------	-----------------------------------	-------------------------------------	----------------------

Back to Index Returns to the Blend4Web SDK index page.

Create New Project Opens the project creation wizard.

Import Project(s) Opens the project import dialogue.

Export Project(s) Opens the project export page.

Hide Stock Projects Can be used to hide stock projects. If such projects are already hidden, this command is replaced with the Show Stock Projects command.

Help Opens the [Help](#) file.

Commands for managing a specific project is located at its right.

Note: Some commands may not be available depending on the type of the project.

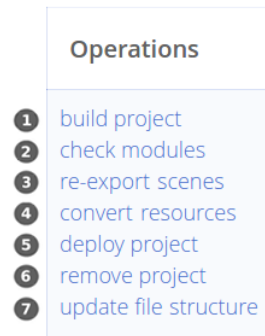

1. Build project (not available for Web Player JSON and Web Player HTML projects).
2. Check for missing or unnecessary API modules (not available for Web Player JSON and Web Player HTML projects).

Activating this option will make the Project Manager check the modules used by the application and output the results of the check to the console. Possible warning messages are listed below:

- (a) If one or more API modules are missing from the project's folder, the following message will be displayed:

Module 'module_name' is missing in the 'project_name.html' project, please include it or run 'Update Modules'.

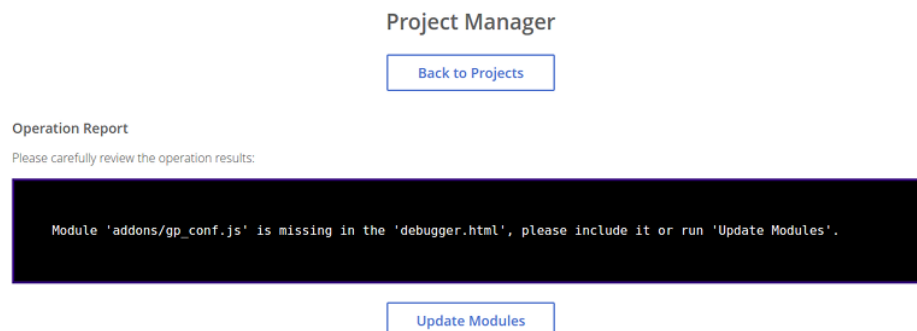

These missing modules can be appended to the project with the Update Modules button.

- (a) If the project has one or more API modules that are not used anywhere in the program code, the following message will be displayed:

Incorrect module 'module_name' in the 'project_name.html', please remove it or run 'Update Modules'.

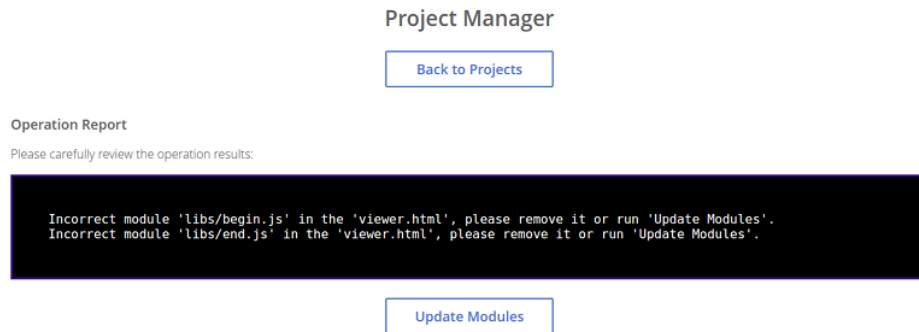

These incorrect modules can be removed from the project with the Update Modules button.

- (a) In case no problems with missing/unnecessary modules have been detected, the following message will be displayed:

Module check complete. No problems detected in the 'module_name.html'.

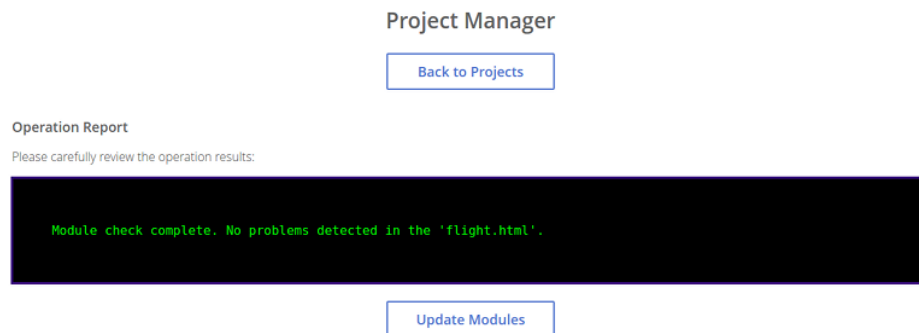

3. Re-export blend files from the project.
4. Convert media resources.
5. Export and download a project archive.
6. Remove the project.
7. Update file structure. Available only for the project created with versions of Blend4Web older than 16.12.

Note: All project paths are retrieved from its .b4w_project config file.

Beside the project's name are located the links to the

1. project information page,
2. project file editor and
3. project configurator.

The application type is also specified there. An application can have one of the following types:

Player The application can be played using the Web Player.

Dev Application for development.

Build Compiled application.

Project Creation Wizard

The tool for creating new projects is included in the Project Management app and executed by the [Create New Project] button on the main page of this app.

Create a new project

Back to Projects
Help

1	Project Name (required) <small>for better compatibility, use only letters and underscores</small>	<input style="width: 95%;" type="text" value="my_project"/>
2	Project Title (optional) <small>choose a human-readable name</small>	<input style="width: 95%;" type="text"/>
3	Project Author / Company (optional) <small>choose a human-readable name</small>	<input style="width: 95%;" type="text"/>
4	Create Application Starter Files <small>create starter html/js/css files</small>	<input checked="" type="checkbox"/>
5	Create Scene Starter Files <small>create starter blend/json/bin files</small>	<input checked="" type="checkbox"/>
6	Use Material Library <small>copy material library blend and asset files into your project directory</small>	<input type="checkbox"/>
7	Copy Project Management Script <small>simplifies project management for users who prefer using command line tools</small>	<input type="checkbox"/>
8	Application Type <small>if unsure, leave the default value see help for more info</small>	Custom Type <input checked="" type="radio"/> Copy <input type="radio"/> Compile <input type="radio"/> None WebPlayer Type <input type="radio"/> Web Player JSON <input type="radio"/> Web Player HTML
9	JavaScript Obfuscation Level <small>if unsure, leave the default value see help for more info</small>	<input checked="" type="radio"/> Simple <input type="radio"/> Advanced <input type="radio"/> Whitespace Only
10	Web Player Params <small>default Web Player URL params</small>	<input type="checkbox"/> Show FPS (show_fps) <input type="checkbox"/> Auto-rotate camera (autorotate) <input type="checkbox"/> Disable social network buttons (no_social) <input type="checkbox"/> Background transparency (alpha) <input type="checkbox"/> Use compressed textures (compressed_textures) <input type="checkbox"/> Use compressed textures pvr (compressed_textures_pvr) <input type="checkbox"/> Use min capabilities (min_capabilities) <input type="checkbox"/> Use gzip compression (compressed_gzip)

Create Project

The [Back to Projects] button can be used to return to the Project Manager’s main page, while the [Help] button can be used to access the [Help file](#).

1. Project name is used to name project directories such as “projects/project_name”, “projects/project_name/assets”, “projects/project_name/blender” and “projects/project_name/build”.
2. Project title as shown in the browser.
3. Project author’s name.
4. Add application templates. Standard application templates: html file, css file, js file will be added to the project directory “projects/project_name”.

5. Add scene templates. Standard json file will be added to the “projects/project_name/assets” directory; blend file will be added to the “projects/project_name/blender” directory.
6. Use Material Library. Blend files of the material library will be copied to the project directory “projects/project_name/blender”, while the asset files will be copied to “projects/project_name/assets” folder.
7. Copy project manager script. The project.py script will be copied to the project directory.
8. Project’s type. Several options are available:
 - Copy - engine files will be directly copied from the deploy/apps/common/ to the application folder.

When the project is deployed, only application files are compiled, while engine files are left intact (so you cannot modify the engine itself);
 - Compile - engine sources are compiled with application scripts.

This option can be used to modify the code of the engine itself;
 - None - Project Manager will not copy the engine files to the application folder, nor will it perform any operations upon building the application. Application developers will have to manually perform everything they need;
 - Web Player JSON - json-file placed inside the project is run with the help of web-player inside SDK;
 - Web Player HTML - project is packed into single html-file, containing all required resources.
9. Javascript optimization level.
 - “Simple” - variable names are replaced in the code;
 - “Advanced” - code optimization is performed;
 - “Whitespace Only” - only whitespaces are removed from the code.
10. Web Player URL attributes. This tab is available only if Engine Binding Type parameter is set to Web Player JSON or Web Player HTML.
 - “Show FPS” is used to display the FPS counter in the player’s top right corner.
 - “Auto-rotate camera” enables automatic camera rotation just after the scene loads.
 - “Disable social network buttons” disables social networks buttons on the control panel.
 - “Background transparency” enables transparency for the rendering area.
 - “Use compressed textures” enables loading of minified and [compressed textures](#) (in DDS format).

- “Use compressed textures pvr” enables loading of minified and [compressed textures](#) (in PVR format).
- “Use min capabilities” makes Web Player run application as if it was running on a low-end system (on a mobile device, for example).
- “Use gzip compression” enables using [gzip](#) compression.

Creating a Web Player Application

The main advantage of Web Player applications is the ease of deploying such applications on a website.

<p>Application Type</p> <p>if unsure, leave the default value</p> <p>see help for more info</p>	<p>Custom Type</p> <p><input checked="" type="radio"/> Copy <input type="radio"/> Compile <input type="radio"/> None</p> <p>WebPlayer Type</p> <p><input type="radio"/> Web Player JSON <input type="radio"/> Web Player HTML</p>
--	---

Creating a Web Player application is simple. All you have to do when creating a new project is select the Web Player JSON or Web Player HTML option under the Application Type tab.

The parameters that are available for a Web Player project are mostly the same as for any other type of project. The only exception is the group of parameter known as the Web Player Params.

Project Settings

<p>Web Player Params</p> <p>default Web Player URL params</p>	<p><input type="checkbox"/> Show FPS (show_fps)</p> <p><input type="checkbox"/> Auto-rotate camera (autorotate)</p> <p><input type="checkbox"/> Disable social network buttons (no_social)</p> <p><input type="checkbox"/> Background transparency (alpha)</p> <p><input type="checkbox"/> Use compressed textures (compressed_textures)</p>
--	--

This panel is only available if the Web Player JSON or Web Player HTML option has been enabled. The parameters listed here are in essence URL attributes that the Web Player application will use while running the project.

Project Building and Deploy

After the work on a project is completed, it can be built and deployed to a web server. All of this is described in a [dedicated section](#).

Project Information

This page contains information regarding the selected project and can be viewed by the [\[info\]](#) link beside the project's title.

Project Info

[Back to Projects](#)
[Help](#)
[Config](#)

Project Name	flight
Project Title	The Island
Project Author / Company	Blend4Web
Project Icon	.b4w_icon.png
Applications	[detected automatically]
Engine Binding Type	External
Size	130 Mb
Project Path (Development Directory)	apps_dev/flight
Project Config	apps_dev/flight/.b4w_project
Build Directory	deploy/apps/flight
Blend Directory(s)	blender/flight_over_island
Assets Directory(s)	deploy/assets/flight_over_island
URL Params	
JavaScript Obfuscation Level	advanced
JS Compilation Pass-Through List	
CSS Compilation Pass-Through List	
Build Ignore List	
Deployment Assets Directory	
Deployment Assets URL Prefix	
Deployment Ignore List	

[Back to Projects](#)
[Help](#)
[Config](#)

Commands

Back to Projects Returns to the Project Manager's main page.

Help Opens the Help file.

Project Parameters

Project Name The name of the project.

Project Title Project title as shown in the browser.

Project Author / Company The name of the project's author or the title of the developer company.

Project Icon The icon of the project.

Applications Project applications.

Engine Binding Type The type of the project.

Project Path (Development Directory) Project's directory.

Project Config Project's config file.

Build Directory Project build directory.

Blend Directory(s) Directories where project's blend files are located.

Assets Directory(s) Directories where project's media assets are located.

URL Params The list of [URL parameters](#) used to start the application.

JavaScript Obfuscation Level JavaScript optimization level.

JS Compilation Pass-Through List The list of pass-through exceptions for the project's JavaScript files compilation.

CSS Compilation Pass-Through List The list of pass-through exceptions for the project's style sheets compilation.

Build Ignore List The list of exceptions for project's builds.

Deployment Assets Directory Directory where assets will be placed for deployed project.

Deployment Assets URL Prefix URL path prefix to assets directory inside deployed project as reported by `get_assets_path()`.

Deployment Ignore List The list of exceptions for project's deploy.

Project Editing

A simple web-based interface for editing project files is available by the [edit] link beside the project's title.

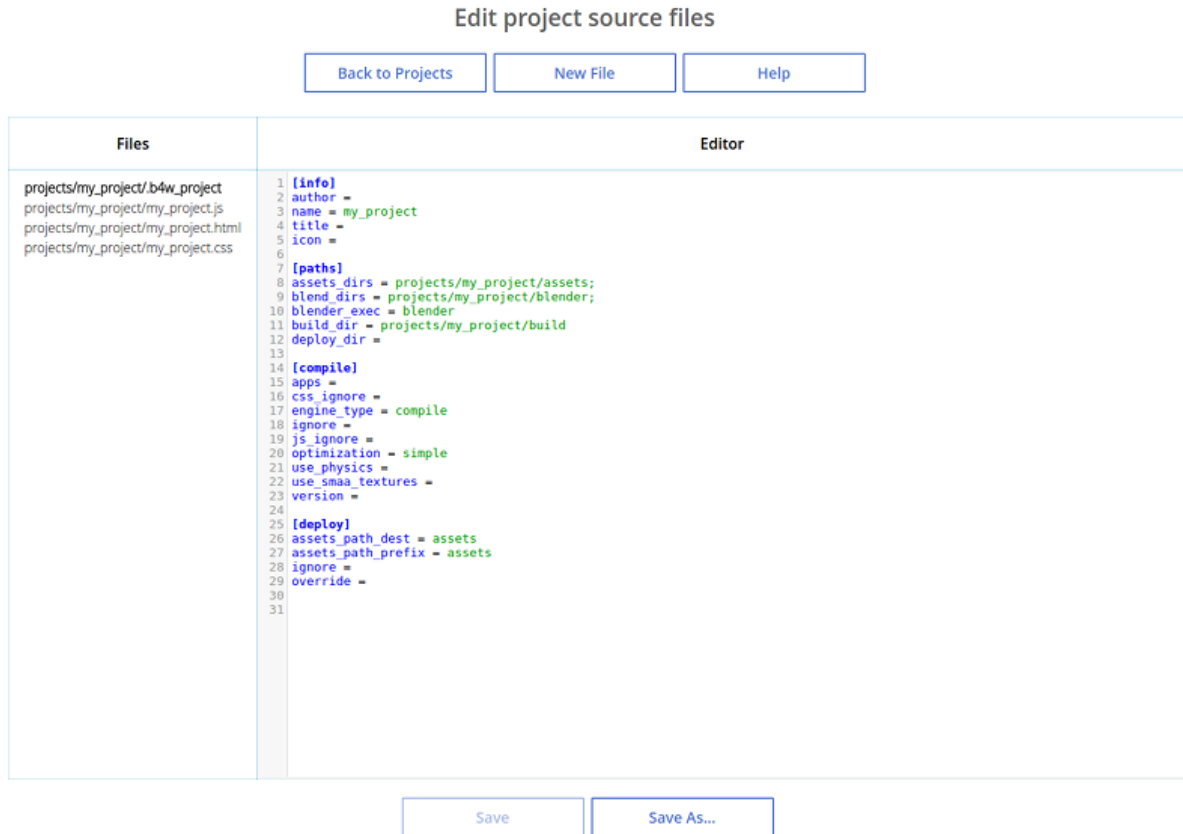

The left part of the editor window contains a list of all .html, .css and .js files from the project directory (projects/my_project). The right part contains the content of a currently selected project file (no file is selected by default) with highlighted syntax.

Note: This interface can only be used to edit files from developer version of a project, but not from the built version.

New .html, .js and .css files can be added to the project directory by clicking the [New File] button.

The [Save] and [Save As...] buttons that can be found at the bottom of the page are used for saving currently selected project file.

Project Config

This is a web interface that allows the developer to view and change project settings after the project is created.

Project Config

[Back to Projects](#) [Help](#)

Info	
Name	Environment Settings Example
Title	<input type="text" value="Environment Settings Example"/>
Author	<input type="text"/>
Icon	 <input type="button" value="Choose File"/> No file chosen
Build	
Apps	<input type="text"/>
Use Physics	<input checked="" type="checkbox"/>
Engine Binding Type	<input type="radio"/> External <input checked="" type="radio"/> Copy <input type="radio"/> Web Player JSON <input type="radio"/> Compile <input type="radio"/> None <input type="radio"/> Web Player HTML
JavaScript Obfuscation Level	<input checked="" type="radio"/> Simple <input type="radio"/> Advanced <input type="radio"/> Whitespace Only
JS Compilation Pass-Through List	<input type="text"/>
CSS Compilation Pass-Through List	<input type="text"/>
Build Ignore List	<input type="text"/>
Paths	
Developer Project Path	apps_dev/Environment Settings Example
Build Project Path	<input type="text" value="deploy/apps/Environment Settings Example"/>
Blend Directory(s)	<input type="text" value="blender/Environment Settings Example"/>
Assets Directory(s)	<input type="text" value="deploy/assets/Environment Settings Example"/>
Blender Exec	<input type="text" value="blender"/>
Deployment Path	<input type="text"/>
Deploy	
Deployment Assets Directory	<input type="text" value="assets"/>
Deployment Assets URL Prefix	<input type="text" value="assets"/>
Deployment Ignore List	<input type="text"/>
Override Deployment Path	<input type="checkbox"/>
URL GET Params	
	<input type="text"/>

[Back to Projects](#) [Save Config](#)

This page include all settings available during project creation along with some additional parameters. Some of the parameters are read-only (and thus cannot be changed after the project is created).

Info Settings Group

Name The name of the project.

This is a read-only parameter.

Title Project title as shown in the browser.

Author The name of the project's author or the title of the developer company.

Icon The icon of the project in the Project Manager.

The icon can be replaced with the Choose File button. If an icon is not specified (as it is by default), Blend4Web logo is used.

Build Setting Group

Apps The list of the project's .HTML files that are used for compiling applications. Each .HTML file is considered a separate application.

Use Physics Enables and disables adding physics engine files to the project. Can be turned off if the project does not use physics.

This parameter is always disabled for a WebPlayer HTML type project and always enabled for a WebPlayer JSON type. For other types of projects, it can be set manually.

Application Type The type of the project.

This is a read-only parameter, as projects with different types have different inner structure.

JavaScript Obfuscation Level JavaScript optimization level for compiling application.

This parameter is read-only for the None, WebPlayer HTML and WebPlayer JSON type projects.

JS Compilation Pass-Through List The list of pass-through exceptions for the project's JavaScript files compilation.

CSS Compilation Pass-Through List The list of pass-through exceptions for the project's CSS files.

Build Ignore List The list of exceptions for project's builds.

Paths Setting Group

Developer Project Path The path to the application for development.

This is a read-only parameter.

Build Project Path The path to the compiled application.

Blend Directory(s) Path(s) to the blend file directory(ies).

Assets Directory(s) Path(s) to the assets directory(ies).

Blender Exec The path to the Blender executable file.

Deployment Path The path to the folder for project final deployment.

Deploy Setting Group

Deployment Assets Directory Directory where assets will be placed for deployed project.

Deployment Assets URL Prefix URL path prefix to assets directory inside deployed project as reported by `get_assets_path()`.

Deployment Ignore List The list of exceptions for project's deploy.

Override Deployment Path Deletes deployment directory, if it already exists.

URL GET Params

The additional GET parameters for the URL link to the application in the Project Manager interface are specified in this field.

Project setting can be saved by pressing the [Save Config] button at the bottom of the screen.

Project Import

Tools for importing projects are available by the [Import Project(s)] link.

Clicking this link opens standard Open File dialog where you can select the project you need to import.

Project Export

Project exporting window can be accessed by the [Export Project(s)] link.

Export Project(s)

Back to Projects
Hide Stock Projects
Help

Select	Name	Title	Author
<input type="checkbox"/>	azure_grotto	Azure Grotto	Blend4Web
<input type="checkbox"/>	capri	Capri	Blend4Web
<input type="checkbox"/>	capri_char	Capri Char	Blend4Web
<input type="checkbox"/>	webplayer	Web Player	Blend4Web
<input type="checkbox"/>	website	Website	Blend4Web

Archive Name: .zip

Export Project(s)

Commands

Back to Projects Returns to the Project Manager's main page.

Hide Stock Projects Hides stock projects. If such projects are already hidden, this command is replaced with the [Show Stock Projects] command.

Help Shows the Help page.

Export Project(s) Can be used to export selected projects.

Project Parameters

Select Shows if the project is selected for export.

Name The name of the project's directory.

Title Project's title.

Author Project author's name.

Archive Name The name of an archive to which exported projects are packed.

Deploying the Project

After you have completed your project, select the deploy project option from the Operations panel on the Project Manager main page. The project will be exported and packed into a single archive.

Project Manager

[Back to Projects](#)

Operation Report

Please carefully review the operation results:

```
Compressing deployed project
Project Environment Settings Example has been deployed
```

[Download](#)

After that, this archive can then be downloaded by to the folder where your web browser stores all downloaded files by pressing the Download button. It should be noted that the process of downloading can take a significant amount of time depending on the size of the archive.

To place the project on a webpage, you have to extract this archive and upload its files to a web server using FTP, SSH or any other protocols supported by the server.

Note: The internal structure of the archive and relative paths to its files should be retained after uploading the project files to a web server.

A Web Player HTML application can then be placed on any webpage by using an iframe container. Here is an example of HTML code that can be used for this:

```
<!DOCTYPE html>
<html>
<head>
  <title>An Example Application</title>
</head>
<body>
  <iframe width="800" height="500" allowfullscreen src="/projects/myproject/myproject.html"></iframe>
</body>
</html>
```

Deploying a JSON project is performed similarly, but instead of a single HTML file it uses a combination of the Web Player app and a JSON file that contains the actual scene.

```
<!DOCTYPE html>
<html>
<head>
  <title>Another Example Application</title>
</head>
<body>
  <iframe width="800" height="500" allowfullscreen src="/myproject/webplayer.html?load=/projects/myproject/myproject.json"></iframe>
</body>
</html>
```

Advanced Project Management

Advanced project management is used by experienced developers which require more flexibility and need to automate process of project development.

For advanced project management use the `project.py` script and manually edit `.b4w_project` configuration files.

The `project.py` script can be found in the `./apps_dev/` folder of the Blend4Web SDK directory. If the Copy Project Management Script option has been set while creating the project, the script can also be found in the root folder of the project.

Dependencies

The project management system works in all operating systems. However, some operations can require installing additional dependencies. In order to check whether all dependencies are met, use the following command:

```
./project.py check_deps
```

For MS Windows users:

```
python project.py check_deps
```

For script operation it's required to install java and set the `PATH` system variable.

Note: Java is included by default in the Windows version of the SDK. In Linux and macOS it should be installed manually.

[Resource Converter](#) also uses its own set of external tools that are described in [another section](#).

Projects List

The list of all projects in the SDK can be viewed with the following command:

```
python3 project.py -p myproject list
```

Project Structure

This is how the structure of a project titled `my_project` and placed in the `./projects` directory in the root of the SDK folder should look:

```
blend4web/  
  projects/  
    my_project/
```

```
assets/  
  my_project.json  
  my_project.bin  
blender/  
  my_project.blend  
build/  
  my_project.html  
  my_project.min.css  
  my_project.min.js  
.b4w_project  
my_project.js  
my_project.css  
my_project.html
```

This app consists of 3 different directories.

1. `my_project/assets`. Contains media files (textures and sounds, as well as the `.bin` and `.json` files) of project's scenes.
2. `my_project/blender`. Contains `.blend` files of project's scenes.
3. `my_project/build`. Contains files of the built application.

Project's main file `.b4w_project`, as well as the `.js`, `.html` and `.css` files, is placed in the root of the `my_project/` folder.

Additionally, the `deploy` command can create yet another directory, but it's usually placed outside of the SDK and its name and path depend on directory structure on the target server.

Note: Starting from the version 16.12, project structure has been changed. Projects that use old structure still do work, but should be considered obsolete. We recommend to use the `update file structure` button to upgrade the structure of such projects to a new one.

This button can be found in the `Operations` panel at the right side of the project's entry in the `Project Manager` list. It is only available for user projects (not for stock ones) that use the obsolete project structure.

Project Configuration File (`.b4w_project`)

Project configuration file includes all necessary information of your project, including name, metadata, directories, info for application building and deployment.

Project configuration file can be edited manually, but a more convenient way is to use [Project Editing](#) interface.

```
[info]  
author = Blend4Web  
name = my_project
```

```
title = MyProject
icon =

[paths]
assets_dirs = projects/my_project/assets;
blend_dirs = projects/my_project/blender;
blender_exec = blender
build_dir = projects/my_project/build
deploy_dir =

[compile]
apps =
css_ignore =
engine_type = external
ignore =
js_ignore =
optimization = simple
use_physics =

[deploy]
assets_path_dest = assets
assets_path_prefix = assets
ignore =
override =
```

This is a standard INI configuration file, which includes sections, properties and values.

Section [info]

Contains project metadata:

author The name of the project's author or the title of the developer company.

name The name of the project.

title Project title as shown in the browser.

icon The icon of the project.

Section [paths]

Contains project paths:

assets_dirs Directories where project's media assets are located.

blend_dirs Directories where project's blend files are located.

blender_exec Path to Blender executable.

build_dir Project build directory.

deploy_dir Project deployment directory.

Section [compile]

apps Project applications.

css_ignore The list of pass-through exceptions for the project's style sheets compilation.

engine_type The type of the project.

ignore The list of exceptions for project's builds.

js_ignore The list of pass-through exceptions for the project's JavaScript files compilation.

optimization JavaScript optimization level.

use_physics Indicates whether your project will use physics or not. Default - use physics.

use_smaa_textures Indicates whether your project will use SMAA textures or not. Currently unused.

version Project version.

Section [deploy]

assets_path_dest Directory where assets will be placed for deployed project.

assets_path_prefix URL path prefix to assets directory inside deployed project as reported by `get_assets_path()`.

ignore The list of exceptions for project's deploy.

override Replace existing output directory during deployment phase. Use with caution.

Section [url_params]

Optional section for Web Player projects. Contains [URL params](#) used to start project applications.

Creating a Project

```
./project.py init my_project
```

This command will create a project with the specified name in the current directory. By default the project directory will only contain a config file.

Available parameters:

- -A | --copy-app-templates (optional) create standard app templates in the project directory (`my_project_dev.html`, `my_project.js`, `my_project.css`).
- -C | --author (optional) write an author's or a company's name in the config file.
- -o | --optimization (optional) write the script optimization level in the config file.

- -P | --copy-project-script (optional) create a copy of the project.py script in the project directory.
- -S | --copy-scene-templates (optional) create standard scene templates in the directories projects/my_project/assets and projects/my_project/blender (my_project.json/.bin and my_project.blend correspondingly).
- -T | --title (optional) write a title in the config file. Upon building, it will be used inside the <title> HTML element.
- -t | --engine-type (optional) write an engine type in the config file.

Example:

```
./project.py init -AS -C Blend4Web -o simple -T MyProject -t external my_project
```

This command will create a directory named my_project, inside which the following files will be placed: my_project.js, my_project.css, my_project_dev.html and .b4w_project.

The .b4w_project file will look like:

```
[info]
author = Blend4Web
name = my_project
title = MyProject
icon =

[paths]
assets_dirs = projects/my_project/assets;
blend_dirs = projects/my_project/blender;
blender_exec = blender
build_dir = projects/my_project/build
deploy_dir =

[compile]
apps =
css_ignore =
engine_type = external
ignore =
js_ignore =
optimization = simple
use_physics =
use_smaa_textures =
version =

[deploy]
assets_path_dest = assets
assets_path_prefix = assets
ignore =
override =
```

Developing multiple apps inside a project

A project can contain multiple apps. This can be provided by listing the corresponding HTML files in the config file separated with semicolon:

```
...
[compile]
apps = myapp1;myapp2;
...
```

If the apps field is empty, every html file in the project directory will be considered an application.

Building Projects

```
python3 project.py -p my_project compile
```

Builds a project in the projects/my_project/build directory.

Available parameters:

- "-a | --app" (optional) specify an HTML file, relative to which the project app will be built.
- "-c | --css-ignore" (optional) add CSS styles to exceptions in order to not compile them.
- "-j | --js-ignore" (optional) add scripts to exceptions in order to not compile them.
- "-o | --optimization" (optional) specify the optimization level for JavaScript files: whitespace, simple (by default) or advanced.
- "-v | --version" add version to paths of scripts and styles.

Compiler Requirements

- In the root of the directory the single html file must be stored if -a option is disabled
- Scripts and styles can be stored in the app's root and in the subfolders

Automatic Blend File Export

```
python3 project.py -p my_project reexport
```

This command will re-export blend files in JSON and HTML formats.

Available parameters:

- "-b | --blender-exec" path to the blender executable.
- "-s | --assets" specify directory with scene assets.

Resource Conversion

```
python3 project.py -p my_project convert_resources
```

Converts external resources (textures, audio and video files) into alternative formats to ensure cross-browser and cross-platform performance.

Available parameters:

- "-s | --assets" specify directory with scene assets.

Converting of resources is described in detail in the [corresponding section](#).

Deploying Projects

```
python3 project.py -p my_project deploy DIRECTORY
```

Save a project to an external directory together with all dependencies.

Available parameters:

- "-e | --assets-dest" destination assets directory ("assets" by default).
- "-E | --assets-prefix" assets URL prefix ("assets" by default).
- "-o | --override" remove directory if it exists.
- "-s | --assets" override project's assets directory(s).
- "-t | --engine-type" override project's engine type config.

Remove Project

```
python3 project.py -p my_project remove
```

Removes a project. Removed directories are retrieved from project configuration file.

Upgrading Apps for New SDK Versions

While upgrading for new SDK versions often two problems arise:

1. Modules of the new and old versions of the engine do not match.
2. Old and new engine API do not match.

In order to update the list of modules imported in developer version of application go to project source directory `apps_dev/my_project` and execute module list generator script:

```
python3 ../../scripts/mod_list.py
```

For MS Windows users:

```
python ../../scripts/mod_list.py
```

Note: To run the scripts the Python 3.x needs to be installed in your system.

The console will print the list of modules - copy them and paste into the main HTML file:

```
<head>
  <meta charset="UTF-8">
  <meta name="viewport" content="width=device-width, initial-scale=1, maximum-scale=1">
  <script type="text/javascript" src="../../src/b4w.js"></script>
  <script type="text/javascript" src="../../src/anchors.js"></script>
  <script type="text/javascript" src="../../src/animation.js"></script>
  <script type="text/javascript" src="../../src/assets.js"></script>
  <script type="text/javascript" src="../../src/batch.js"></script>
  <script type="text/javascript" src="../../src/boundings.js"></script>
  <script type="text/javascript" src="../../src/camera.js"></script>
  ...
</head>
```

To eliminate API incompatibilities you may require refactoring of your app. All changes are described in [release notes](#).

Scene Viewer

Table of Contents

- Scene Viewer
 - Navigation
 - The Side Panel
 - * Information Panel
 - * Basic Control Buttons
 - * Additional Panels
 - Tools & Debug
 - Animation
 - NLA
 - Shape Keys
 - Materials
 - Lighting
 - Ambient
 - Shadows
 - Sky
 - Sea
 - Mist
 - Wind
 - Wind Bending
 - Screen Space Amb Occlus
 - God Rays
 - Bloom
 - Motion Blur
 - Glow Materials
 - Depth of Field
 - Color correction
 - Audio
 - Stereo View
 - Input Devices
 - Indicators

Running The Scenes Viewer.

Navigation

To control the camera hold down a mouse button and move the mouse. Control can also be performed using the W, A, S, D, R, F keys: forward, left, back, right, up, down. Arrows and numpad keys can be used as well. In the Target camera mode it's possible to focus on the selected object using the Z or .(dot) keys.

The Side Panel

The side panel consists of three areas: the information board, basic control buttons and the list of drop-down panels with additional control elements differentiated by functionality.

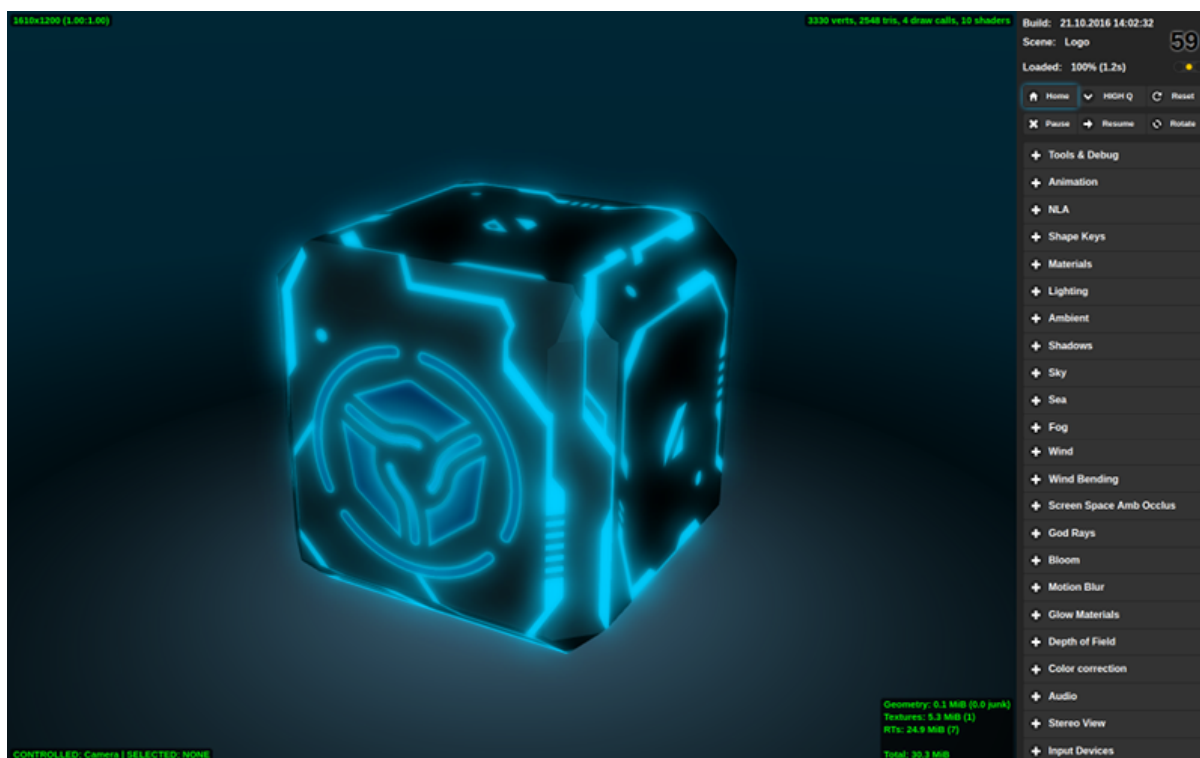

Control elements list in top-to-bottom order

Information Panel

Build The engine build date and time. In the developer version this shows the page load time.

Scene The name of the loaded scene. Path to the file pops-up on mouse hover.

Loaded Loading progress and time.

Basic Control Buttons

Home Reloads the last scene exported from Blender using the Fast Preview button or, if Scene Viewer hasn't been run from Blender, the default scene is loaded.

Reset This button deletes the saved name of the last viewed scene and reloads the page back to display the default scene.

LOW Q - HIGH Q - ULTRA Q Drop-down menu for choosing the performance profile of the engine.

See also:

[Quality Profiles](#)

Pause Pause rendering.

Resume Resume rendering.

Rotate Enables and disables camera orbiting the loaded scene. Disabled by default.

Additional Panels

Tools & Debug

This panel contains a range of debugging tools, including:

Overview Outlining Mode Turning this option on makes all objects in the scene [selectable](#) and enables [outline animation](#) to be played upon selecting them. This feature is enabled by default.

Auto View Mode Pressing this button will cause Scene Viewer to load every scene from the Scenes list within one second of each other. This feature can be used to check all available content for console errors.

Canvas Resolution Factor This parameter can be used to increase the resolution of a canvas. The value can vary from 1 to 10. Default value is 1.0 (canvas resolution is equal to the physical resolution of the Scene Viewer window).

Note: The highest available resolution of a canvas may be limited by a web browser.

Make Screenshot This button can be used to make screenshots of the Scene Viewer's window. Screenshots are stored in the same folder that web browsers use for storing downloaded files.

Debug View Modes The list of different rendering modes that can be used for debug purposes. Available modes are:

NONE - normal rendering mode. This is the default mode.

OPAQUE WIREFRAME - the scene is rendered in flat white color with darker wireframe. The color used for rendering the wireframe can be adjusted by using the Wireframe Edge Color parameter.

TRANSPARENT WIREFRAME - the scene is rendered as in normal mode, but wireframes are added on top of it. Like in the previous mode, the color used for rendering the wireframe can be adjusted by using the Wireframe Edge Color parameter.

FRONT BACK VIEW - renders front and back sides of the polygons with different colors.

BOUNDINGS - this mode adds wireframe spheres that envelope [objects](#) and [meshes](#). The spheres can be blue (for static objects/meshes) or red (for dynamic objects).

CLUSTER VIEW - in this view mode, every object in a specific cluster (used for [batching](#)) is rendered with a specific color.

BATCH VIEW - in this view mode, every batch is rendered using a specific (flat) color. The colors used in rendering can be changed to randomly generated colors by clicking the Change Colors button.

RENDER TIME - the scene is rendered in different colors to represent the complexity of various parts of the scene. The lightest parts are rendered using shades of green, heavier - shades of orange, and the most resource-demanding parts of the scene are colored red.

Change Colors This button randomly changes the colors that are used in the CLUSTER VIEW and BATCH VIEW rendering modes. This feature is useful in cases when colors that are picked randomly by the engine are too similar and make it difficult to distinguish parts of the image.

Render Time Threshold (ms) This parameter sets a “threshold” time for the RENDER TIME view mode. If the engine spends more time on rendering a certain object than the time set by this value, this object will be colored red. The default value is 1.5 ms.

Wireframe Edge Color This parameter allows you to change the color of the wireframe edges used in the OPAQUE WIREFRAME and TRANSPARENT WIREFRAME view modes.

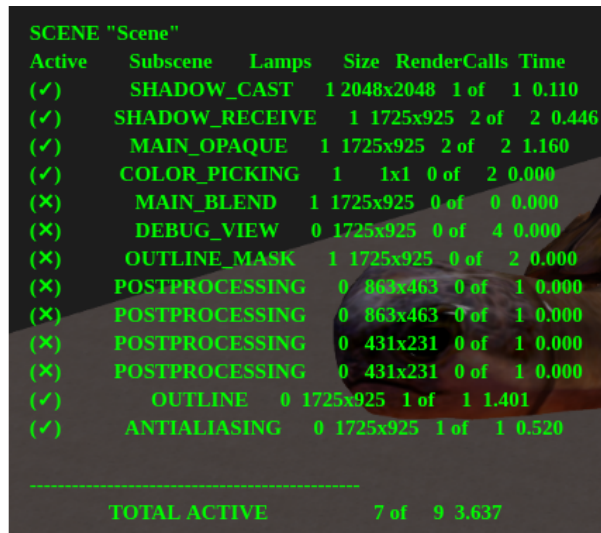

SCENE "Scene"						
Active	Subscene	Lamps	Size	RenderCalls	Time	
(✓)	SHADOW_CAST	1	2048x2048	1 of 1	0.110	
(✓)	SHADOW_RECEIVE	1	1725x925	2 of 2	0.446	
(✓)	MAIN_OPAQUE	1	1725x925	2 of 2	1.160	
(✓)	COLOR_PICKING	1	1x1	0 of 2	0.000	
(✗)	MAIN_BLEND	1	1725x925	0 of 0	0.000	
(✗)	DEBUG_VIEW	0	1725x925	0 of 4	0.000	
(✗)	OUTLINE_MASK	1	1725x925	0 of 2	0.000	
(✗)	POSTPROCESSING	0	863x463	0 of 1	0.000	
(✗)	POSTPROCESSING	0	863x463	0 of 1	0.000	
(✗)	POSTPROCESSING	0	431x231	0 of 1	0.000	
(✗)	POSTPROCESSING	0	431x231	0 of 1	0.000	
(✓)	OUTLINE	0	1725x925	1 of 1	1.401	
(✓)	ANTIALIASING	0	1725x925	1 of 1	0.520	

TOTAL ACTIVE			7 of 9 3.637			

HUD Info

This button shows a list of rendered subscenes and its parameters, including:

SCENE The name of the current scene.

Active Shows whether the subscene is active or not.

Subscene The name of the subscene.

Lamps The number of light sources in the subscene.

Size The size of the render of the subscene.

RenderCalls The number of draw calls in the subscene.

Time The amount of time the engine spends on rendering the subscene.

TOTAL ACTIVE The number of draw calls in all present subscenes and the time that the engine spends on rendering them.

Enabling this parameter may decrease performance of a scene. This option is disabled by default.

GL Debug This parameter, when activated, causes the engine to process low-level errors. This can significantly decrease performance. It is disabled when you start Scene Viewer for the first time, and afterwards, the application will save the state of this option for the next time.

Min Capabilities Mode This parameter makes Scene Viewer run a loaded scene as if it was running on a low-end system (on a mobile device, for example). This allows an artist to find out which materials in the scene may not work as intended with low-end configuration. Disabled by default.

Animation

Animation controls. When viewing animated models, you can select an object and switch its animation with a drop-down menu, switch cyclic animation mode, stop and resume animation, set the required frame (the animation should be stopped to do this).

Available parameters:

Play All Pressing this button will play all available animations.

Stop All Pressing this button will stop playback of all animations that are currently being played.

Object A list of scene objects that have animations.

Animation Slot The list of all animation slots that can be used to apply some animation to an object.

Animation A list of all animations available for a selected object.

Cyclic If this parameter is enabled, the animation will be played repeatedly. If it isn't, the animation will stop after being played once. Enabled by default.

Range This value shows the length of the selected animation.

Status This value shows the status of the animation, i.e. if it is being played or stopped.

Playing Animation > Play Plays the selected animation.

Playing Animation > Stop Stops the selected animation.

Set Frame Shows the current frame of the animation and can be used to set the current frame.

Skeletal Mix Factor The factor of mixing different skeletal animations together. Default value is 1.0.

NLA

A tool to control Non-Linear Animation (if it is present in the scene). For this panel to work, NLA option should be enabled in the scene's settings.

Available parameters:

Range Shows the start and the end frame of the NLA strip.

Status Shows the status of NLA animation, i.e. if it is being played or stopped.

Playing NLA > Play This button can be used to play NLA animation.

Playing NLA > Stop This button can be used to stop NLA animation that is currently being played.

Set Frame If an animation is stopped at the moment, this parameter can be used for setting a specific frame of NLA animation.

Shape Keys

Shape Keys control. When viewing models that has shape keys, you can select an object, one of its shape keys and the influence that the key has on the object.

Available parameters:

Object This list contains all scene objects that have Shape Keys.

Shape Key This list contains all Shape Keys attached to a selected object.

Set Value This parameter sets the level of influence of a selected Shape Key on an object. The value can vary from zero to 1.

Materials

Material properties setup. A material can be selected using the drop-down menu. For now, this feature only supports a limited number of properties and only stack (non-node) materials applied to dynamic objects (node materials and static objects are not supported).

Available parameters:

Material A list of all stack materials present in a scene.

Color This parameter defines the base color of a selected material.

Reflectivity This parameter sets the reflectivity factor of a selected material. Its value is equal to zero by default.

Fresnel The power of the Fresnel effect for the reflection. Set to zero by default.

Fresnel Factor A factor of the Fresnel effect. Set to zero by default.

Parallax Scale The scale parameter of the parallax effect. This value can vary from zero to 0.1. Default value is 0.

Parallax Steps The number of steps used for building a parallax surface. The value can vary from 1 to 30. Default value is 5.

Lighting

Setup for direct lighting parameters. A light source can be selected using the drop-down menu. Changing color and intensity is supported. Daytime and sun lighting parameters can also be tweaked on this panel.

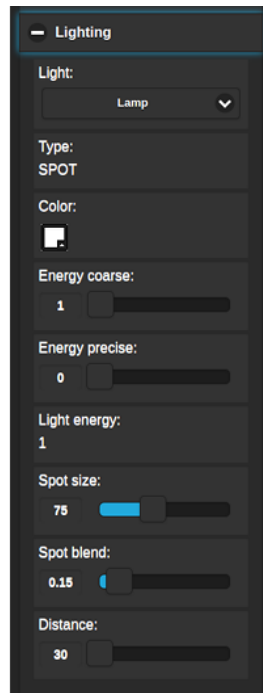

Available parameters:

Light This list contains all light sources present in the scene.

Type The type of the selected light source. This parameter cannot be changed in the Scene Viewer.

Color The base color of the selected light source. By default, white (1; 1; 1) is used.

Energy Coarse This parameter sets the integral part of the energy value for the light source. The value of this parameter can vary from zero to 100. Default value is 1.

Energy Precise This parameter sets the fractional part of the energy value for the light source. The value of this parameter can vary from zero to 1. Set to zero by default.

Light Energy This value is calculated as the sum of the Energy Coarse and Energy Precise parameters. In case both of them have default values, it will be equal to 1.

Spot Size Angle of the light beam emitted by the light source. Default value is 75. This parameter is only available for Spot type light sources.

Spot Blend This defines the softness of the spotlight edge. Default value is 0.15. This parameter is also available for Spot type light sources only.

Distance This parameter sets the distance (in meters) from the light source at which the light emitted by the light source will be half as bright as defined by the Light Energy value. Set to 30 by default.

The following parameters are only available for Sun type light sources:

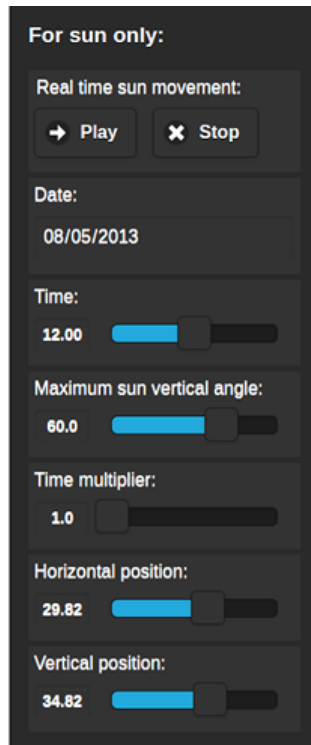

Real Time Sun Movement > Play Pressing this button activates real-time sun movement.

Real Time Sun Movement > Stop Pressing this button stops real-time sun movement.

Date This parameter sets the current date.

Time This parameter set the current time of day. Default value is 12.0.

Maximum Sun Vertical Angle This parameter sets maximum possible vertical angle for a Sun type light source. Default value is 60.

Time Multiplier The value of this parameter defines the speed of the flow of time. Default value is 1.0 (time flows at the same speed it does in real life).

Horizontal Position Horizontal position of the sun on the skydome. Default value is 29.82.

Vertical Position Vertical position of the sun on the skydome. Default value is 34.82.

Ambient

Setup for ambient lighting parameters. Changing the colors and intensity of a hemispheric ambient model is supported.

The settings available for ambient lighting setup are the same as the ones in Blender. They are described in the [dedicated section](#).

Shadows

Setup for shadow parameters, including shadow cascades and shadow edges softening parameters.

The options for setting up shadows are described in the [corresponding section](#) of this manual.

Sky

Setup for dynamic sky parameters such as color, sun light scattering parameters etc.

Scene Viewer has access to all Blender parameters used for setting up procedural sky. These parameters are described in the [corresponding section](#).

Sea

Setup for water rendering parameters, including color transitions by depth and by distance from the shore, foam and subsurface scattering parameters, wave dynamics etc.

The settings for water rendering are described in the [Outdoor Rendering](#) chapter. Scene Viewer uses the same settings as the Blend4Web engine itself.

Mist

Setup for fog parameters.

Scene Viewer uses standard fog rendering settings that are described in the [dedicated chapter](#).

Wind

Setup for wind parameters, including direction and strength.

The same parameters as the ones used by Scene Viewer are available in Blender. These parameters are described in the [corresponding chapter](#).

Wind Bending

Setup for wind bending effect parameters.

The same set of wind bending parameters is available in Blender. It is described in the [Outdoor Rendering](#) chapter.

Screen Space Amb Occlus

Setup for ambient occlusion parameters.

All available settings are described in the [Postprocessing Effects](#) chapter.

God Rays

Setup for crepuscular ray effect parameters.

All parameters for this effect are described in the [corresponding section](#).

Bloom

Setup for bloom effect parameters.

This effect uses the same set of parameters as it does in Blender. It is described in greater detail in the [corresponding section](#).

Motion Blur

Motion blur effect settings.

The parameters for adjusting Motion Blur effect are the same ones that are used in Blender. They are described in the [Postprocessing Effects](#) chapter.

Glow Materials

Glow Material effect settings.

The settings used for this effect are described in the [corresponding section](#).

Depth of Field

Setup for depth-of-field effect parameters.

The parameters are described in the [corresponding chapter](#).

Color correction

Setup for color correction parameters, including brightness, contrast, exposure and saturation.

The same set of parameters is used for color correction in Blender itself. The description of these parameters is available in the [Color Management](#) chapter.

Audio

There is a mixing mode switch on the panel. After it is enabled the mixer interface becomes visible (only for scenes with sound sources).

Mixer Enables equalizer that shows various parameters (including volume, frequency, distance, attenuation and others) of the speakers present in the scene, and allows user to adjust these parameters by using a numerical keypad. The available parameters and possibilities are described in greater detail in the [dedicated section](#) of the [Audio chapter](#).

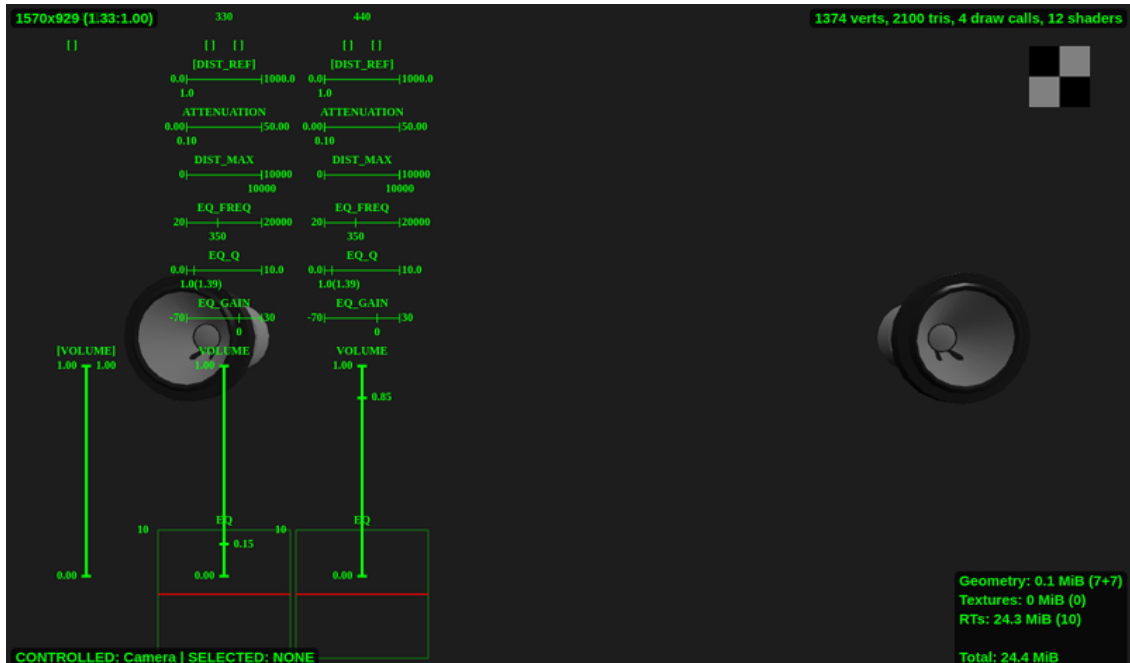

This feature is disabled by default.

Stereo View

There is a stereoscopic mode switch on the panel.

Available parameters:

Stereo Types A list of all available stereo rendering modes. As of today, three types are supported:

NONE - stereo rendering is not used.

ANAGLYPH - [anaglyph](#) rendering is used.

HMD - rendering for [Head-Mounted Displays](#) is used. This option is only available if the system has access to an HMD device.

Default setting is NONE.

HMD Settings Shows the [HMD setup window](#).

Input Devices

This panel contains tools for setting up the input devices.

Gyroscope use Enables the use of the gyroscope in the application. Disabled by default.

Gamepad Settings Clicking this button shows the gamepad settings window.



Indicators

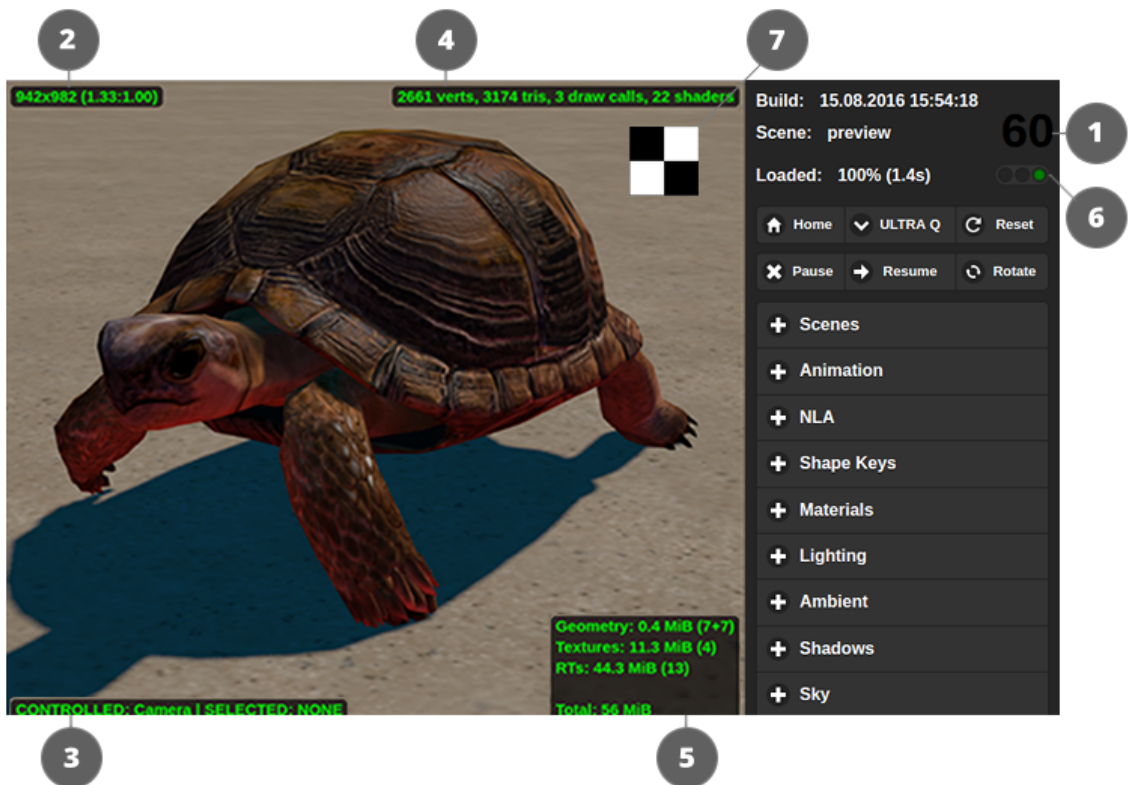

1. Frames per second counter This is located in the top right corner. It displays the averaged and rounded value for the last 1.5 seconds.

2. Viewport dimensions This is located in the top left corner. It displays the viewport dimensions in pixels.
3. Selected object and controlled object This is located in the bottom left corner. It displays the names of selected and controlled objects. Selecting an object is done with the mouse. To control the object directly (normally for physics debugging) press the Q key and click on the object. The object movement is performed with the W, A, S, D keys. To exit the control mode press the Q key and click on an empty space. The indicator also displays the distance to the selected object in Blender units (meters equivalent).
4. Scene complexity indicator Is located in the top right corner of the rendering area. It displays the number of vertices, triangles, WebGL draw calls and shaders used in the main rendering scene (i.e. shadow rendering calls are not included, for example).
5. Video memory indicator Is located in the bottom right corner of the rendering area. It displays the amount of video memory used by geometry, textures, render targets, and also the total memory usage.
6. Scene load error indicator Is located under the FPS counter. It shows errors and warnings which occur during scene load. Red light means errors, yellow - warnings and green means that the scene was loaded successfully.

Loading errors and warnings can be viewed in the web browser console.

7. Background Transparency Indicator Is located in the top right corner of the screen, right below the Scene Complexity Indicator. This is a debug tool that can be used to find if the background of a scene is transparent or not. It appears as a small square with a black and white checkerboard pattern.

This indicator is visible only when the background of the application is transparent. It is shown on the picture above only to give the reader the general idea of how it will look under real circumstances.

Web Player

Table of Contents

- Web Player
 - Usage
 - Navigation
 - Control Panel
 - Attributes
 - Scene Name as Title
 - Scene Errors

The web player is a special application for rendering models and scenes in a demonstration mode.

Desktop version:

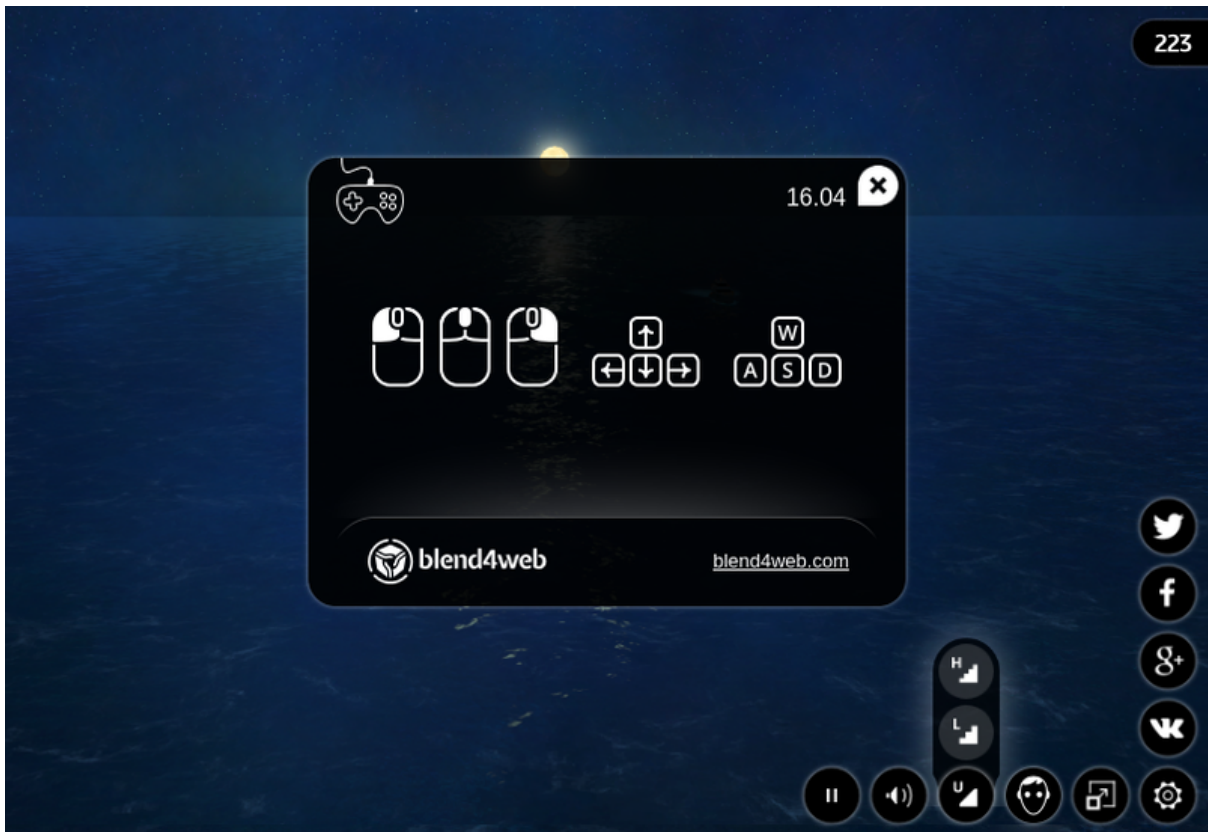

Mobile version:

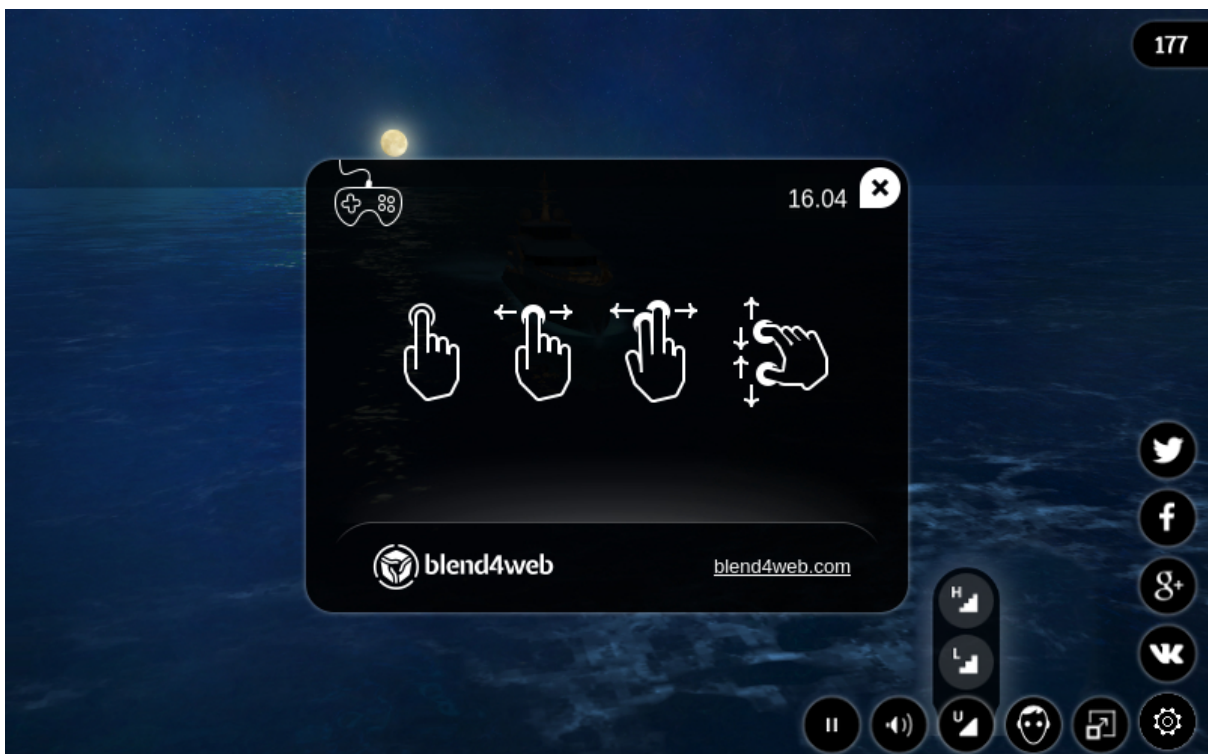

Usage

You can copy the directory containing the web player files, namely `deploy/apps/webplayer`, from the Blend4Web SDK distribution and deploy it on your website. You can place the exported scene files on your website and specify the path to them (absolute or relative) with the load web player parameter.

When you export into a single HTML file the web player interface is integrated automatically into it.

Navigation

The camera (in the Target and Eye modes) is controlled by the mouse with its button pressed or with the keys: W, A, S, D, R, F (forward, left, back, right, up, down). The numpad keys are also supported.

Control Panel

The web player's control panel is shown below.

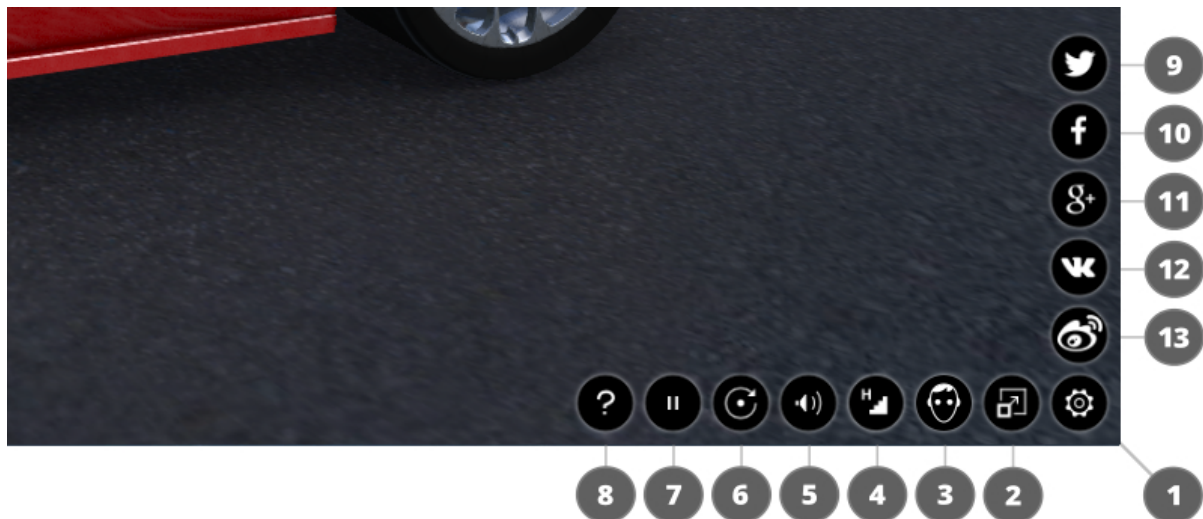

1. show / hide control panel;
2. fullscreen mode on / off;
3. stereo rendering on / off;
4. set the scene quality;
5. sound on / off;

6. camera auto rotation mode on / off;
7. run / stop the engine;
8. open the help window;
9. tweet;
10. share via Facebook;
11. share via Google+;
12. share via VK;
13. share via Weibo.

Attributes

Web player accepts attributes from the browser address line:

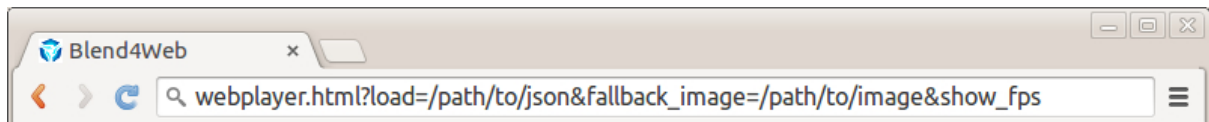

1. the special attribute `load` is used to load the scene, this attribute contains relative path to a JSON file.
2. in case of a WebGL error the optional `fallback_image` attribute is used to setup the background image instead of 3D content.
3. in case of a WebGL error the optional `fallback_video` attribute is used to setup the background video instead of 3D content. Can be used many times to add more video formats.
4. the optional `show_fps` attribute is used to display the FPS counter in the player's top right corner.
5. optional parameter `autorotate` is used to enable automatic camera rotation just after the scene loads.
6. the `compressed_textures` optional parameter is used to enable loading of minified and compressed textures (in DDS format).
7. the `compressed_textures_pvr` optional parameter is used to enable loading of textures compressed in PVRTC format. This parameter is used with the `compressed_textures` parameter.
8. the `compressed_gzip` optional parameter is used to enable loading of GZIP compressed resources such as `".json.gz"`, `".bin.gz"`, `".dds.gz"` and `".pvr.gz"`.

9. optional alpha parameter is used to enable transparency for the rendering area.
10. the optional no_social attribute is used to disable social networks buttons on the control panel.
11. the optional socials attribute is used to selectively enable and disable social network buttons on the control panel. This attribute should look like socials=<...>, where <...> is a set of letters corresponding to the social network buttons you want to enable (f for Facebook, v for VK, t for Twitter, w for Weibo and g for Google+). The order of letters sets the order in which the buttons will appear on the screen.

Note: If both fallback_image and fallback_video parameters are specified, the fallback_image parameter is used.

Scene Name as Title

By default the Web Player has the Blend4Web Web Player title. Assigning the meta tag title on the scene in Blender you can change that value to something else.

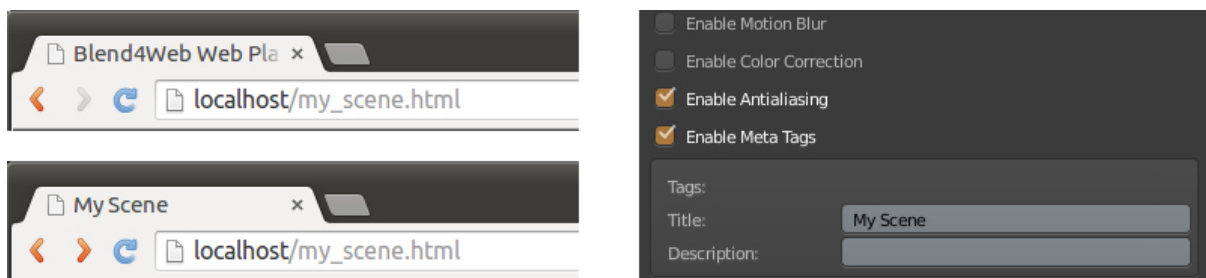

Scene Errors

If the player is used incorrectly it displays the corresponding errors.

1. The load attribute specifies a wrong path to the JSON file or the file is corrupt.

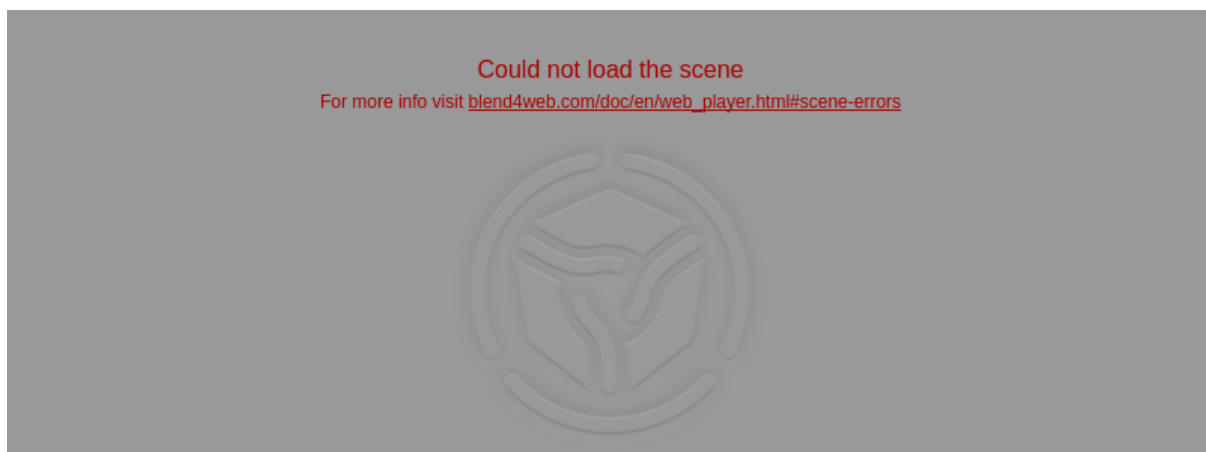

-
2. The load `attribute` is not found or is void.

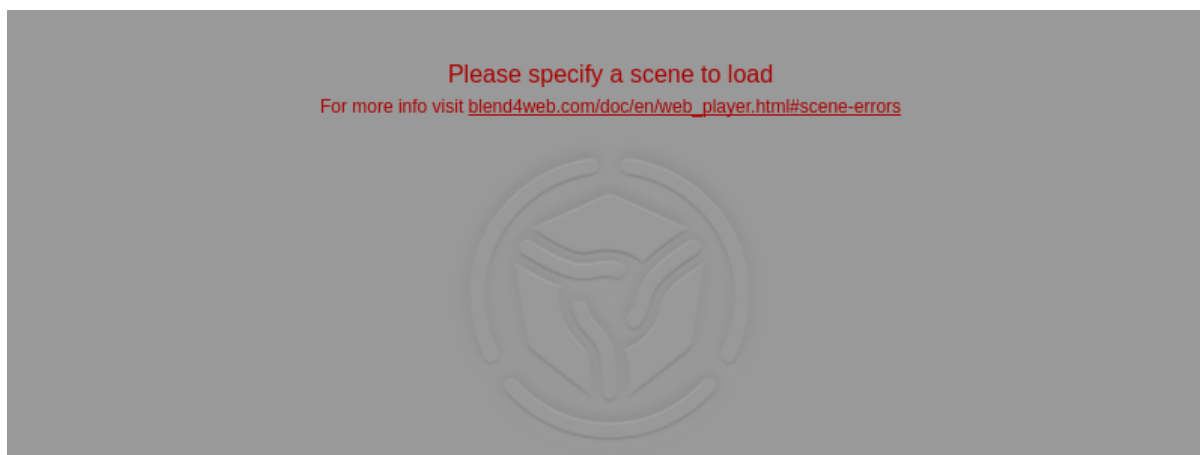

-
-
3. WebGL initialization error. Please, look at [this page](#) for the solution.

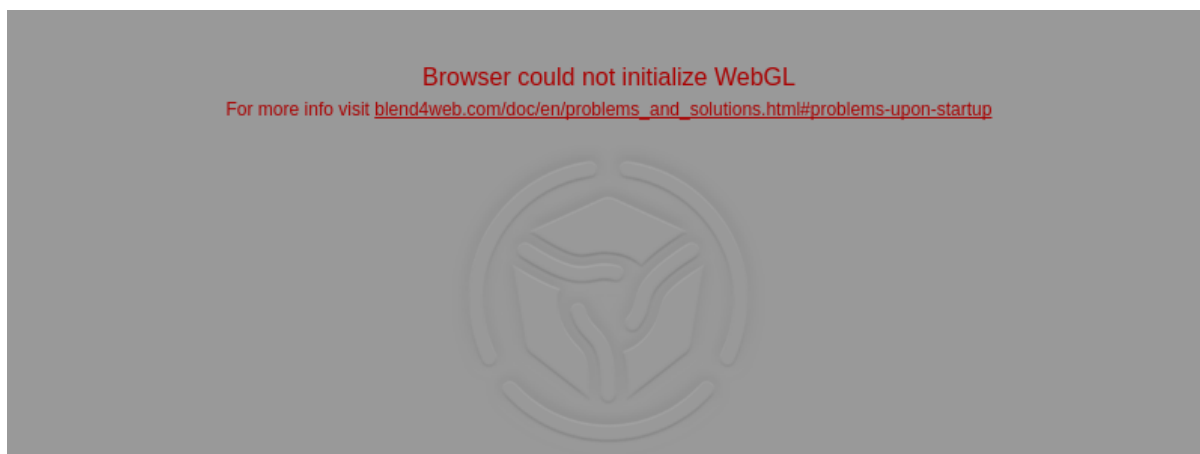
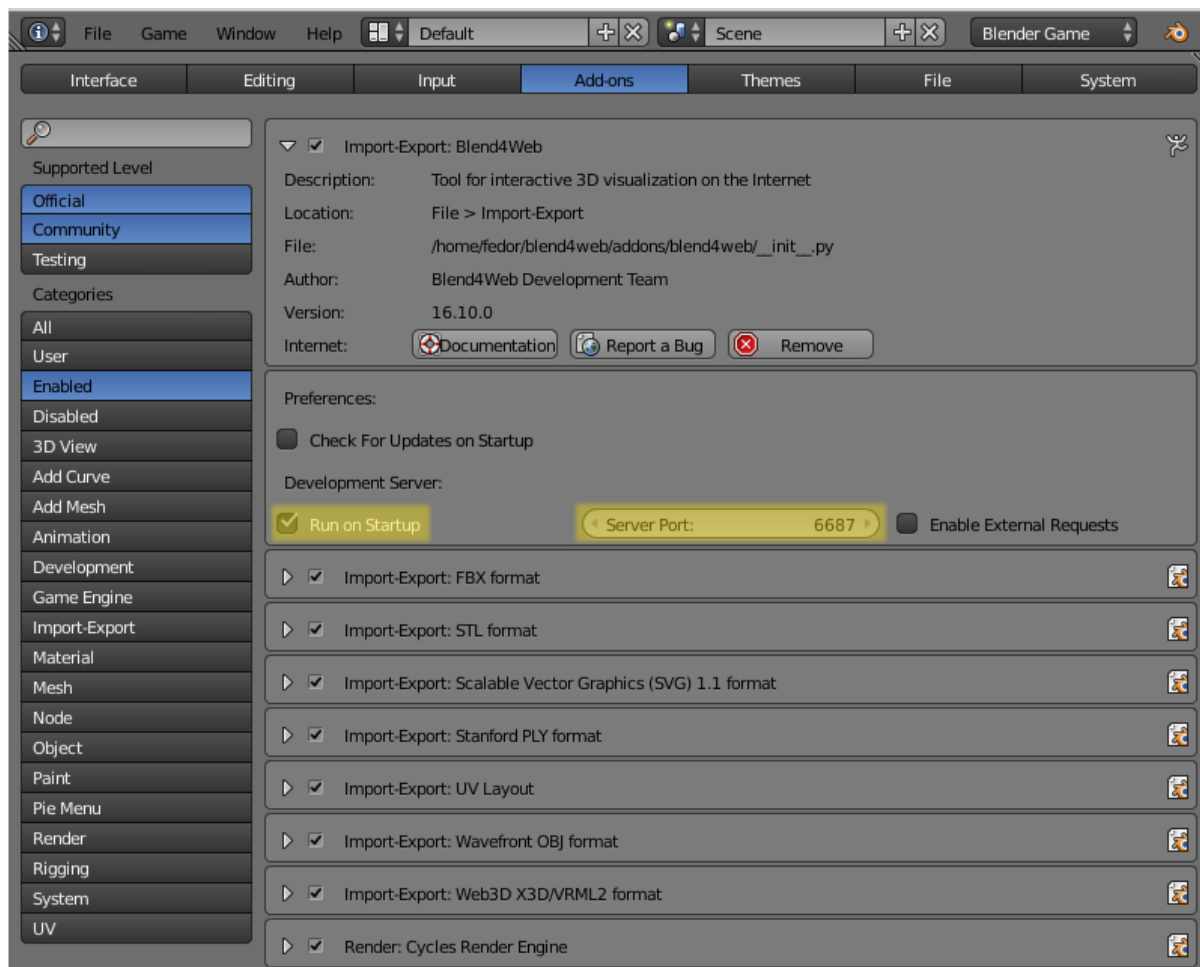

Table of Content

- Add-on
 - Local Development Server
 - Running Viewer and Demos
 - Export Formats
 - * JSON
 - * HTML
 - Export Options
 - Initialization Errors
 - Compatibility Errors
 - Critical Export Errors
 - Non-Critical Export Errors
 - Other Messages
 - Add-on Translations

Local Development Server

Settings for the local development server can be found in File > User Preferences... (hot keys Ctrl-Alt-U). Here you can change the port number to be used to run the development server (6687 by default), and also enable its launching upon Blender startup. To do this, enable Run on Startup option in the add-on settings.



After changing local development server settings in it required to restart Blender.

It is possible for the local server to process external requests. To do that enable the option `Enable External Requests`.

If you chose not to start the server automatically, you can always do it manually: go to the `Render` tab and press the `Start Server` button on the `Development Tools` panel:

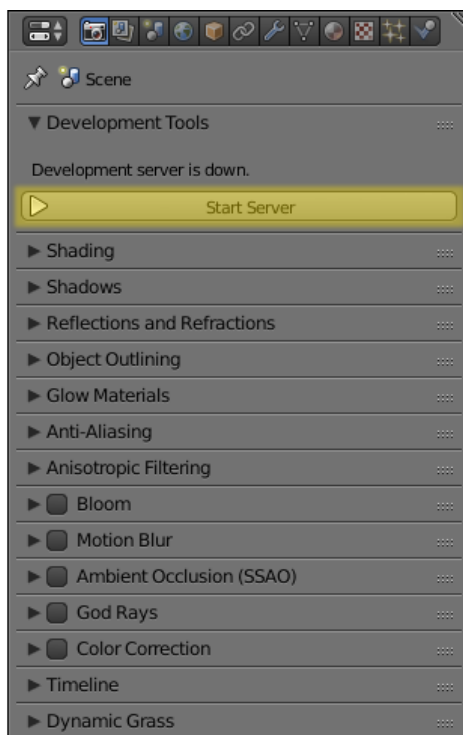

Note: If the local development server cannot be launched, the corresponding message will be displayed instead of the Start Server button.

If the server is failed to run, an error message will be shown describing the reason:

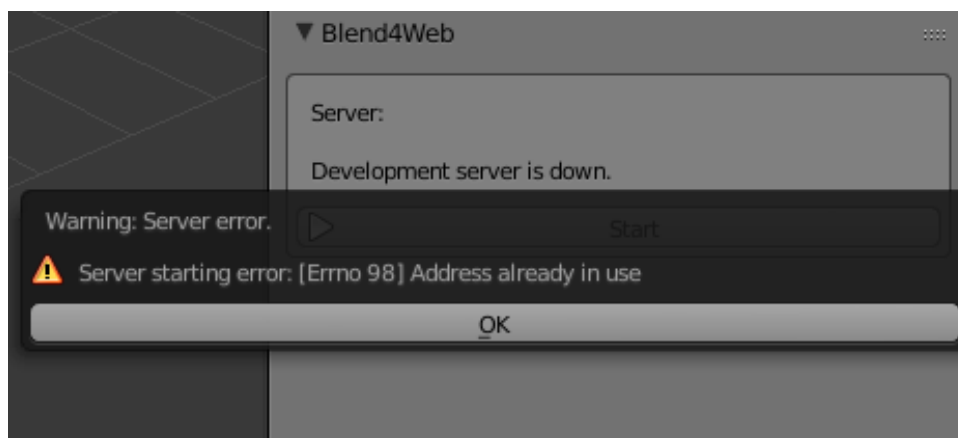

This error can arise if the server port is already used by some other application.

Press the SDK Index button to open the index web page of the Blend4Web SDK in the browser. This page is available at <http://localhost:6687>.



As a result, the default browser for your operating system will be launched.

The Project Manager button can be used to open [project manager](#).

The Fast Preview button loads the scene that is currently open in Blender, into the [viewer](#).

This button is duplicated in the Info panel of the [3D View window](#).



Figure 9.1: Fast Preview button on the Info panel

The button at the right side of it controls data synchronization between Blender and [Scene Viewer](#). If this option is enabled, re-exporting a scene will cause Scene Viewer application (if it is open) to reload and update the scene in accordance to the changes made to it. This option eliminates the need to open preview scene manually after exporting it. It is enabled by default.

Note: The Fast Preview button in the Info panel is available in Cycles render engine as well.

The server can be stopped by pressing the Stop Server button. It also stops when Blender is closed.

Running Viewer and Demos

Blend4Web PRO 17.10 SDK

WebGL: **available**
 Development Server: **available**
 GPU: 1000000 points, bandwidth 10485.8 GB/s

Tools			
Project Manager	Code Snippets		WebGL Report
Helpful Resources			
	English	Русский	中文
User Manual, HTML	read	читать	读
User Manual, PDF	read	читать	读
API Reference	read		
Tutorials	go	перейти	执行
FAQ	go	перейти	执行
Community Support Forums	go	перейти	执行
Support Email	[blurred]		

The index page contains the following links:

- [Project Manager](#);
- [Code Snippets](#), a list of demo applications. A WebGL-capable browser is required to run these apps;
- [WebGL Report](#) page for checking the level of WebGL support provided by the web browser;
- [User Manual](#), available in both HTML and PDF form in three languages;
- [API Reference](#) that contains descriptions for every API module and method provided with the Blend4Web engine;
- [Tutorials](#);

- FAQ page where you can find answers to some of the most basic questions regarding using the engine;
- Community Support Forums;
- Support Email (only available in PRO version).

Note: If the SDK apps are not displayed correctly, or error messages are shown, follow the instructions in the [Problems Upon Startup](#) section.

Export Formats

After the scene is finished, you need to convert it into a format supported by the Blend4Web engine.

For now, two formats are supported: JSON and HTML.

JSON

Exporting the scene to this format creates a .json (JavaScript Object Notation) file that contains all exported data structures and links to external resources (images, sounds and such), and also a .bin file that contains model data arrays in binary format.

If media resources are [packed into the .blend file](#), they will be unpacked during the export and placed in the project's directory (inside the SDK directory). It should be noted that the names of such files will be automatically changed, which can complicate working with them.

It is recommended to store all the resources in a dedicated folder inside the SDK directory, it can be called `projects/project_name/assets` for example.

Note: In accordance with the security measures, the development server can only access the SDK folder. If media data is placed in another folder, the server won't be able to deploy it during the export (even if it is working correctly in Blender itself).

Paths to the external resources should be relative. If this is not the case, execute the File > External Data > Make All Paths Relative command, or else problems with opening the file on other computers may occur.

This is the main format for complex projects that include multiple scenes and require JavaScript programming. Project development is further described in the [corresponding section](#).

HTML

Exporting the scene to this format pack all scene resources into one file with the HTML extension. This HTML file contains not only the scene itself, but also textures, sounds, Blend4Web engine and standard web player. A file like this can be executed on any computer and any mobile device that have a web browser with WebGL support.

You can't use HTML files for further development, but you also don't need any additional actions to run them. This format is useful for developing relatively simple applications of moderate size.

It should be noted, however, that HTML applications do not support following features:

- Physics
- DDS textures
- min50 textures

Export Options

Autosave blend File Autosaving the file from which export occurs. Enabled by default.

Autosaving is performed right after the export to guarantee conformity between the current blend file and the exported file contents. In addition, the relative path to the exported file is saved for convenience.

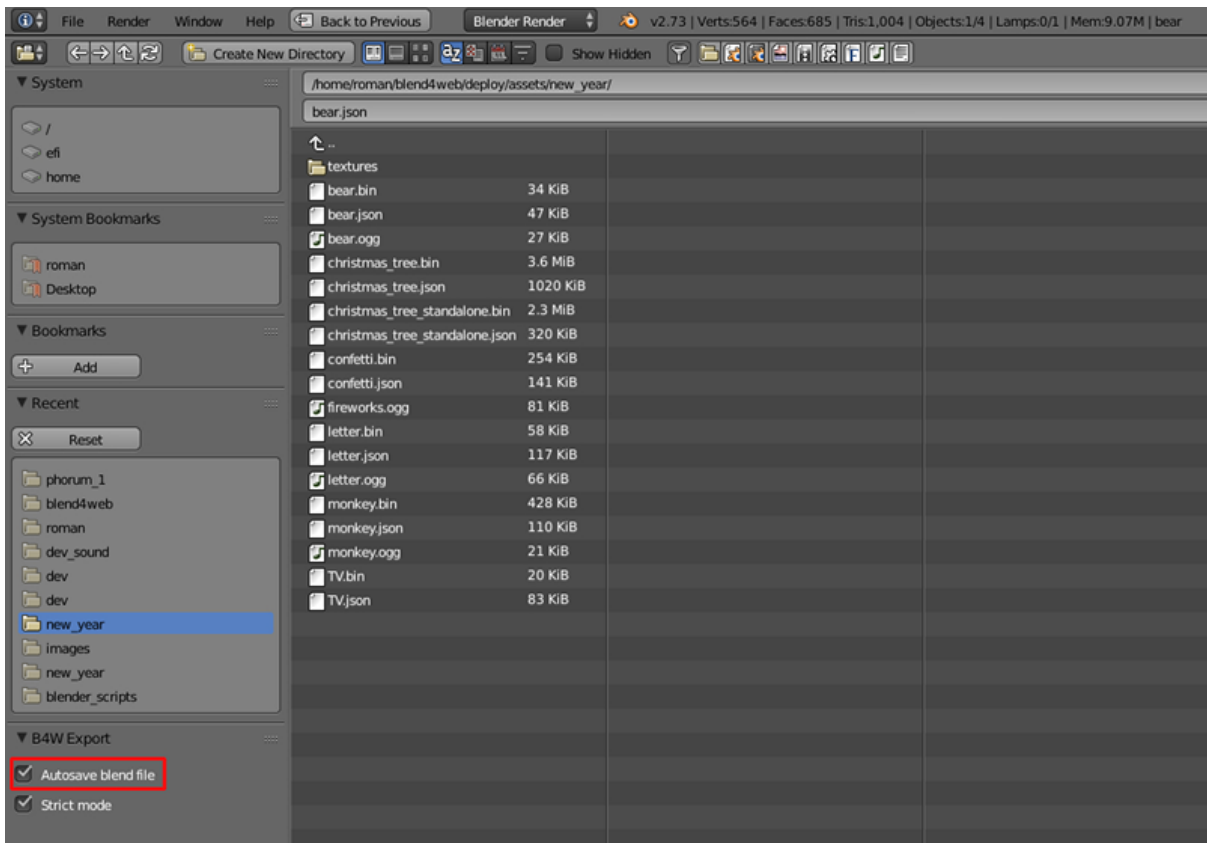

Strict Mode This mode prevents export if there are any errors or messages for users' attention. This mode is enabled with the Strict Mode setting in the export menu:

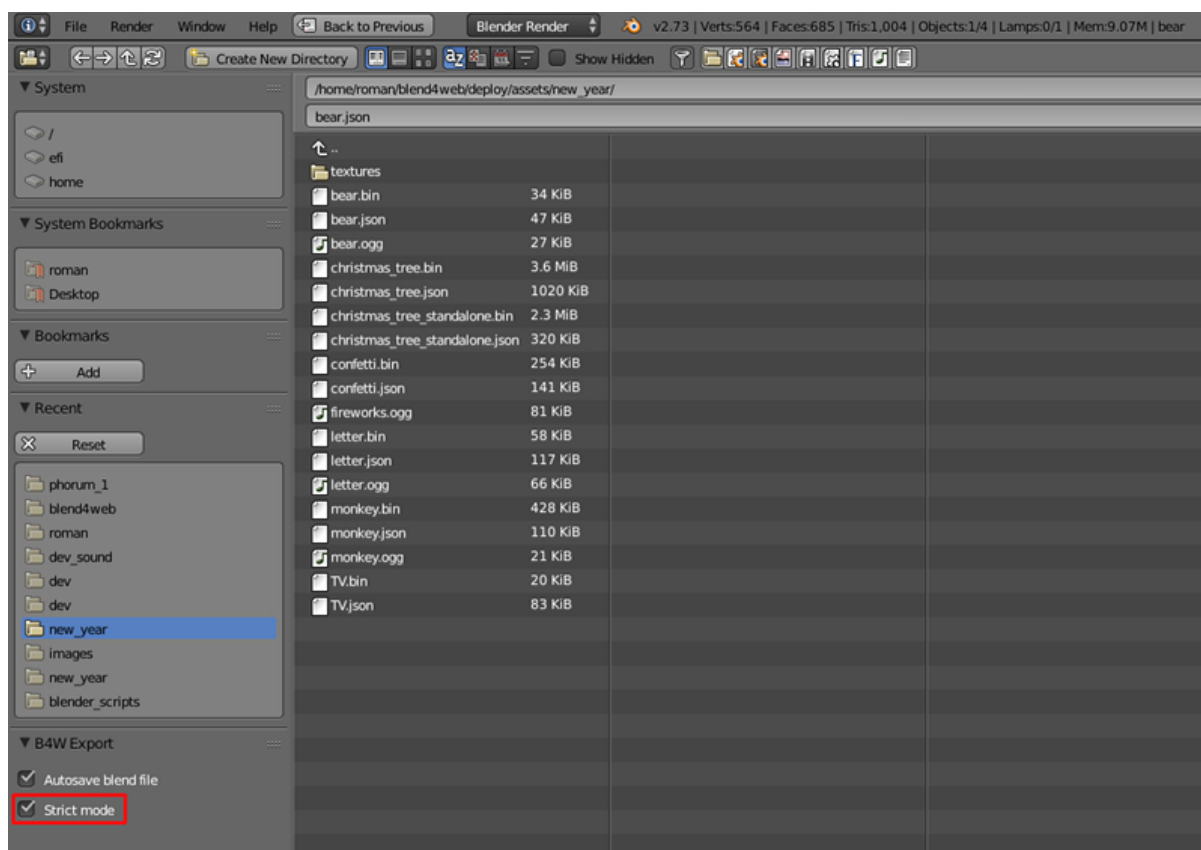

If there are any non-critical errors or messages for users' attention, a dialog window will be show like this:

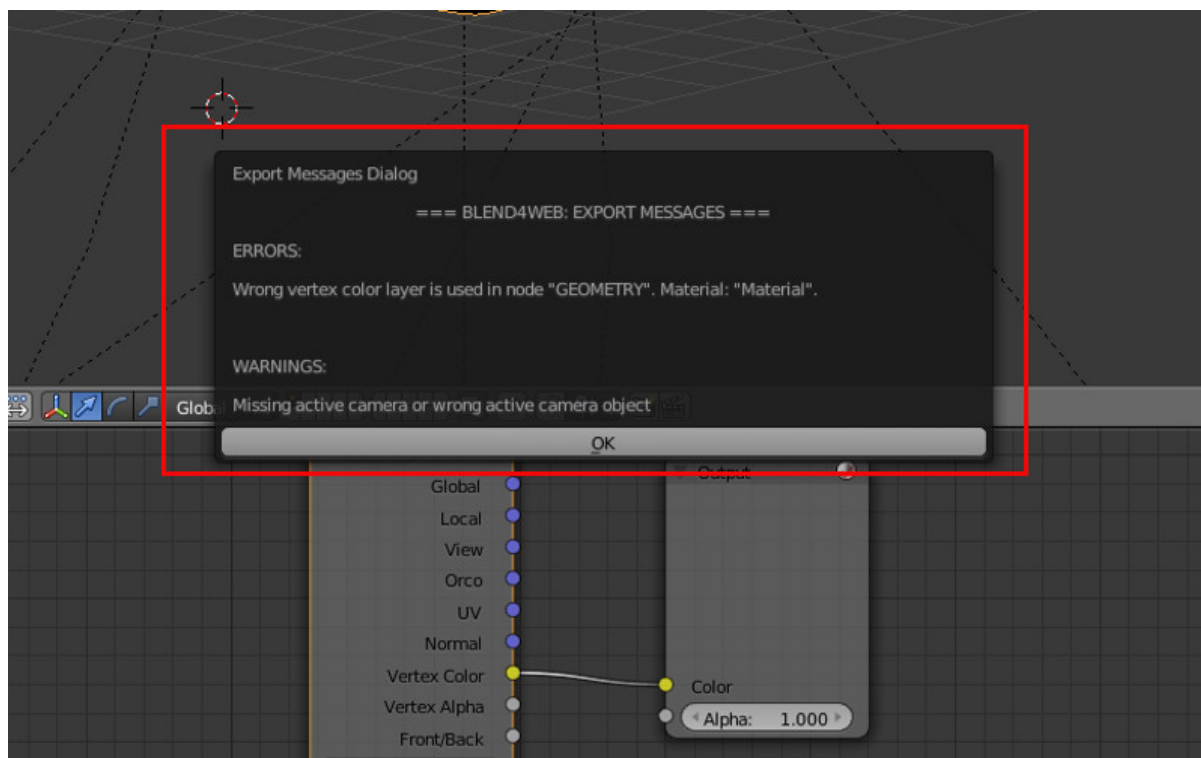

Export Converted Media This option is available for HTML export. When this option is enabled, the converted media files of different formats are written in the HTML file. Using different media files is essential to create cross-browser and cross-platform applications while using HTML export. These files can be created by the [converter](#).

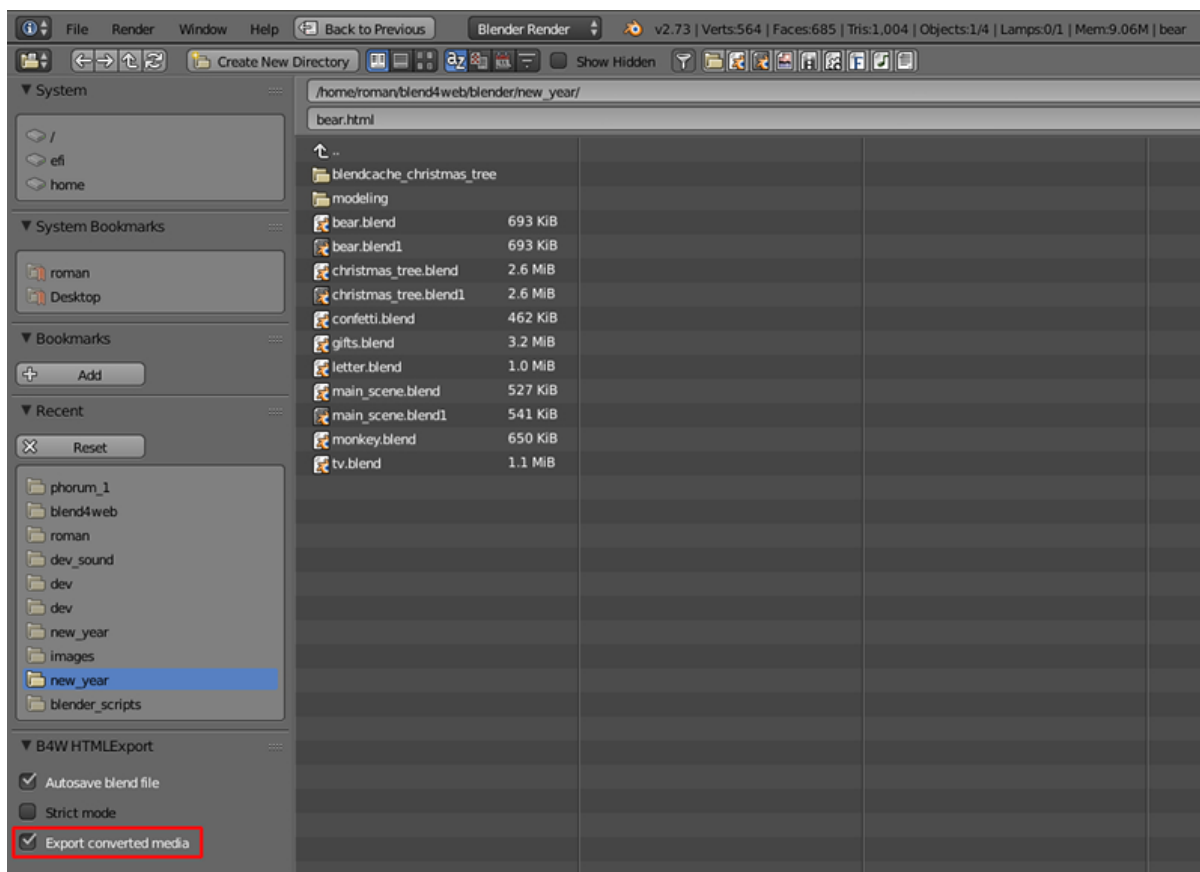

Run in Viewer Automatically launch the Scene Viewer and add the exported scene to it.

When using the [local development server](#), there is a possibility to open the exported .json scene in the Scene Viewer. To do this, select any path inside the Blender4Web SDK file structure upon export.

A directory inside the SDK should be used for export. If not, this option will not be displayed in the menu. Also, it will not be displayed if the local development server is down.

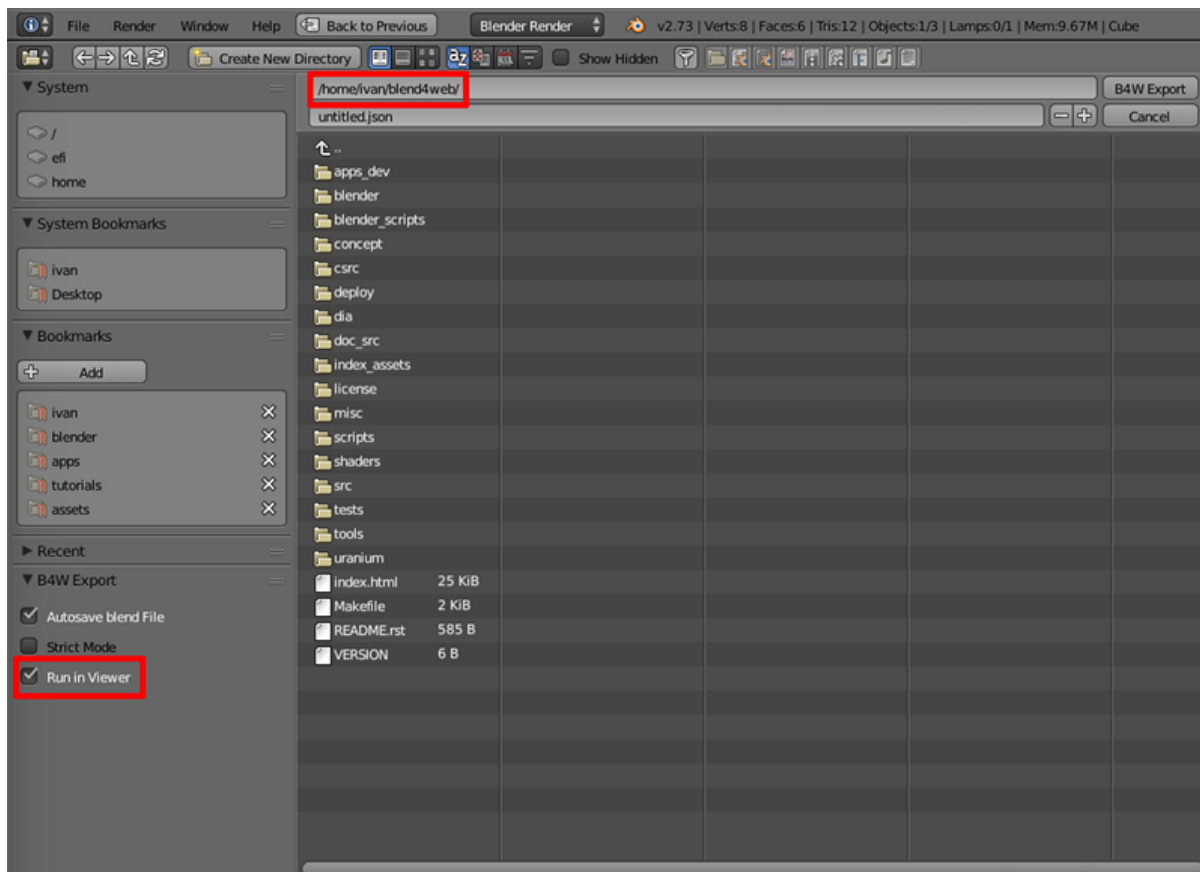

Initialization Errors

Initialization errors can arise upon installation of the add-on or when a scene is opened in Blender. In this case a dialog window with the error description is showed.



Error message	Cause
Blend4Web initialization error! Add-on is not compatible with the PLATFORM platform.	The Blend4Web add-on is not compatible with the PLATFORM platform.
Warning: Blender version mismatch. Blender VER_REQUIRED is recommended for the Blend4Web add-on. Current version is VER_CURRENT.	Warning about possible incompatibility with the current Blender version. It is recommended to use VER_REQUIRED Blender version. The current version is VER_CURRENT.
Incorrect add-on directory name.	Incorrect name of the add-on directory. Add-on structure in the archive has been damaged, or entirety of the archive has been disrupted.

Compatibility Errors

Compatibility errors may arise when trying to view a scene in a browser, in the following cases: if version of the add-on used to export the scene differs from version of the Blend4Web engine which tries to load the scene, or if .bin file does not correspond to the .json file.

Engine version is too old as compared to version of the add-on with which the scene was

exported. The scene will not be loaded. We recommend you to use the latest versions of the engine and the add-on.

Error message	Cause
JSON version is too old relative to B4W engine: VER_OLD, required: VER_NEW. Reexport scene with the latest B4W add-on to fix it.	Version of the add-on, with which the scene was exported, is too old: VER_OLD. The engine requires: VER_NEW. The scene will not be loaded. We recommend you to reexport the scene using the latest version of the add-on. We also recommend to use the latest version of the engine.
JSON version is a bit old relative to B4W engine: VER_OLD, required: VER_NEW. Some compatibility issues can occur. Reexport scene with the latest B4W add-on to fix it.	Version of the add-on, with which the scene was exported, is a bit old: VER_OLD. The engine requires: VER_NEW. The scene will be loaded as usual, however some errors may occur. We recommend you to reexport the scene using the latest version of the add-on. We also recommend to use the latest version of the engine.
B4W engine version is too old relative to JSON. Can't load the scene. Update your engine version to fix it.	Engine version is too old as compared to version of the add-on with which the scene was exported. The scene will not be loaded. We recommend you to use the latest versions of the engine and the add-on.
B4W engine version is a bit old relative to JSON. Some compatibility issues can occur. Update your engine version to fix it.	Engine version is a bit old as compared to version of the add-on with which the scene was exported. The scene will be loaded as usual, however some errors may occur. We recommend you to use the latest versions of the engine and the add-on.
BIN version does not match to JSON version: VER_BIN, required: VER_JSON. Couldn't load the scene. Reexport scene to fix it.	Version of the .bin file is too old relative to .json file: VER_BIN, .json file version is VER_JSON. The scene will not be loaded. We recommend you to reexport your scene.
BIN version does not match to JSON version: VER_BIN, required: VER_JSON. Some compatibility issues can occur. Reexport scene to fix it.	Version of the .bin file is a bit old relative to .json file: VER_BIN, .json file version is VER_JSON. Some incompatibility errors can arise. We recommend you to reexport your scene.

Critical Export Errors

In case of export errors a BLEND4WEB EXPORT ERROR dialog box describing of the problem appears:

COMPONENT - type of component (object, mesh, material, texture etc) that has caused the export error.

NAME - component name.

ERROR - short description of the occurred problem.

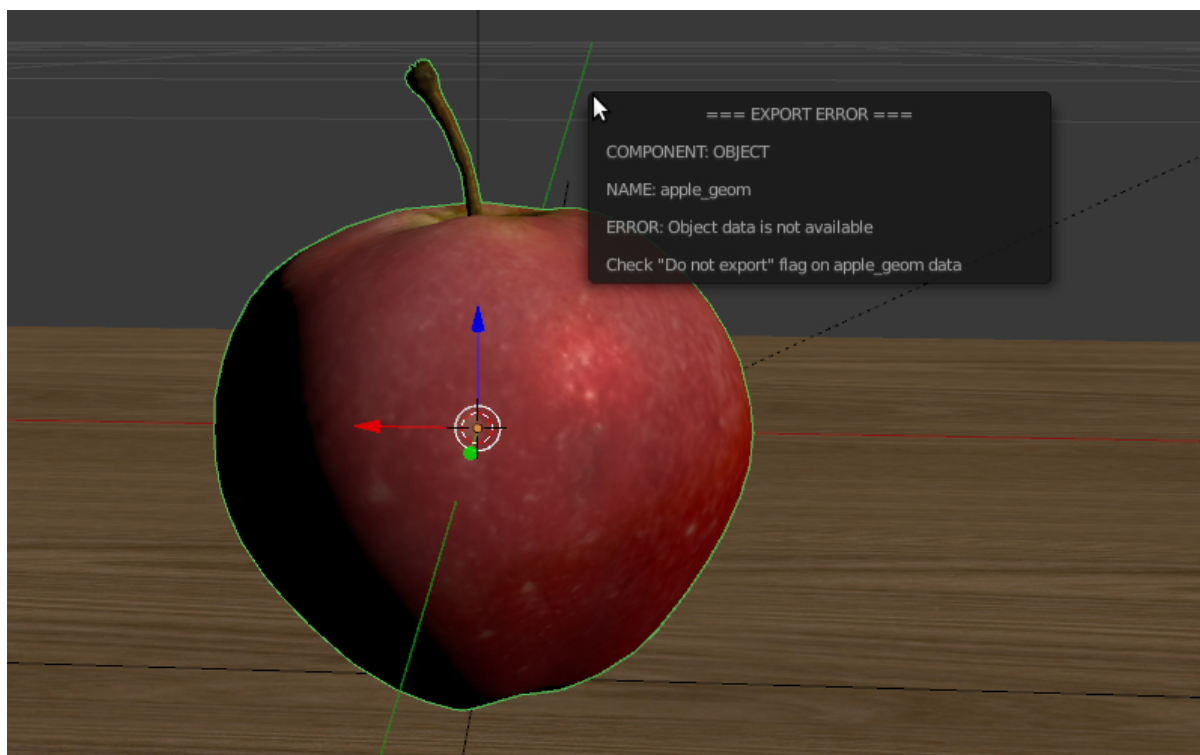

Error message	Cause
Export to different disk is forbidden	Export to a directory located on a different disk is forbidden
Incompatible objects with a shared mesh; The OBJECT_NAME object has both vertex groups and a shared mesh	Incompatible objects with a shared mesh. Export of an object with both a shared mesh and vertex groups is not allowed. Exceptions: export is possible if an object has the Apply modifiers, Export vertex animation, Export edited normals, Apply Scale and Modifiers options turned on (because in these cases a full copying of meshes occurs).
Incorrect mesh; Corrupted file: Wrong vertex color values	Corrupted file: incorrect vertex color value.
Loading of resources from different disk is forbidden	Loading of resources from different disk is forbidden.
The material has a normal map but doesn't have any material nodes	The node material uses Normal Mapping, but has no Material node.
The mesh has a UV map but has no exported material	The mesh has a UV map layer but has no material for export.
The mesh has a vertex color layer but has no exported material	The mesh has a vertex color layer but has no material for export.
No such file or directory	The file or directory does not exist.
Permission denied	No access rights to the current directory.
Wrong edited normals count; It doesn't match with the mesh vertices count	The number of edited normals does not match the number of the mesh vertices. Execute Clean Up or Save in the B4W Vertex Normals Editor panel.
Wrong overridden bounding box; Check the mesh's bounding box values	Wrong dimensions are specified when overriding the mesh's BoundingBox: minimum value is greater than maximum value for at least one of the dimensions.

Non-Critical Export Errors

In contrast to the above-listed critical export errors, these errors do not prohibit the export, but can make scenes displayed incorrectly. These messages can be viewed in the browser console (opens with F12) when a scene is loaded. The message looks like this:

```
B4W EXPORT ERROR: Error message
```

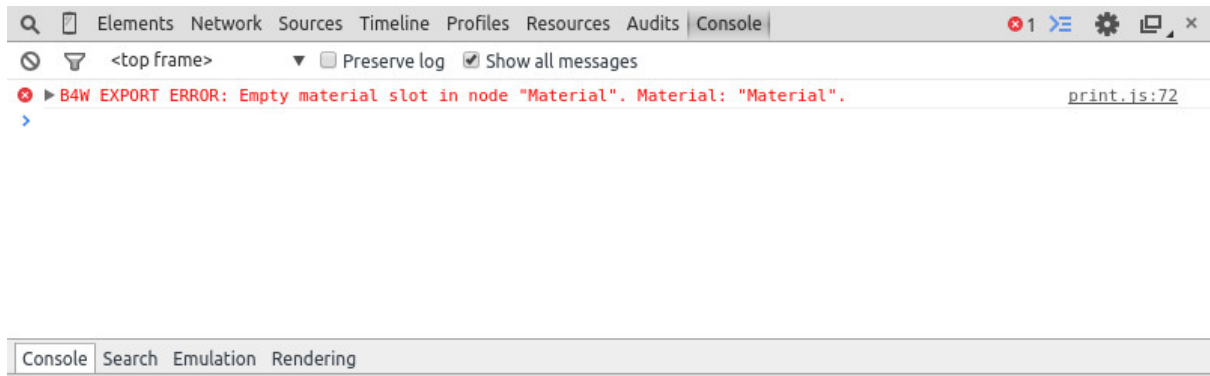

Error message	Cause
Canvas texture ID NAME already exists. Texture NAME.	This Canvas ID already exists.
Dupli group error for object OBJECT_NAME. Objects from the GROUP_NAME dupli group on the OBJECT_NAME object cannot be exported	None of the objects in the GROUP_NAME group which were selected for duplication on the OBJECT_NAME object can be exported. Permission to export at least one object of the group, or to remove the duplication of the group is required.
Empty canvas texture ID for texture NAME.	Canvas ID is empty.
Empty material slot in node "NAME". Material: "NAME".	Empty material slot in "NAME" node.
Environment map in the "NAME" world texture slot cannot be a movie.	Environment map can not be presented with a video file.
Ignoring LODs after empty LOD for the NAME object.	All LOD objects that follow the empty slot were ignored (in the LOD objects list for the NAME object).
Incomplete mesh NAME; Dynamic grass vertex colors required by material settings	The Dynamic grass size and/or Dynamic grass color options are used by the special terrain material but the mesh has no vertex colors with such names.
Incomplete mesh; Material settings require vertex colors	The Vertex Color Paint option is enabled for the mesh material, but the mesh has no vertex color layers.
Incorrect NLA script, falling back to simple sequential NLA.	Incorrect NLA script. Falling back to simple sequential NLA.
Incorrect vertex animation for mesh NAME. Object has no vertex animation.	The object's vertex animation export option is on, but there is no vertex animation.
Incorrect vertex animation for mesh NAME. Unbaked "ANIM_NAME" vertex animation.	Vertex animation export is turned on for the mesh, but the ANIM_NAME animation doesn't have any frames.
Incorrect mesh NAME; Wrong group indices	The mesh has vertices assigned to the non-existing vertex group.
Incorrect mesh NAME; Wrong vertex positions	Corrupted file: incorrect vertex coordinate value.
Incorrect mesh NAME; Wrong normals	Corrupted file: incorrect normal value.
Incorrect mesh NAME; Wrong tangents	Corrupted file: incorrect tangent value.
Incorrect mesh NAME; Wrong texture coordinates	Corrupted file: incorrect texture coordinate value.
Incorrect mesh NAME; Wrong vertex group weights	Corrupted file: incorrect vertex group weight value.

Incomplete vehicle. The NAME vehicle doesn't have any chassis or hull	The modelled NAME vehicle is not complete as it should contain a Chassis or a Hull element.
Incomplete vehicle. The NAME vehicle requires at least one bob	The modelled NAME vehicle is not complete as it should contain at least one Bob element.
Incomplete vehicle. The NAME vehicle requires at least one wheel	The modelled NAME vehicle is not complete as it should contain at least one Wheel element.
Invalid link found in node material. Material: "NAME".	The "NAME" node material contains an incorrect link between nodes.
No image in the NAME texture. [Material: NAME.]	The texture has no image.
No texture for the NAME particle settings texture slot.	No texture in the particle settings' texture slot.
No texture in the NAME world texture slot.	No texture in the NAME world's texture slot.
No texture in the texture slot. Material: NAME.	There is no texture in the material texture slot.
Node material invalid: "NAME". Check sockets compatibility: "FROM_NODE" with "TO_NODE".	Node material error: the input and output types of the link between the FROM_NODE and TO_NODE nodes should match.
Object "NAME" hasn't renderable data. Converted to EMPTY.	An object named "NAME" is degenerate, e.g. has no polygons. The object's type has been changed to EMPTY.
Object: "NAME" > Constraint: "CONSTRAINT_TYPE". Check constraint settings.	The object "NAME" has a constraint of type "CONSTRAINT_TYPE", which isn't configured properly.
Object "NAME" has the mesh with shape keys. The property "Relative" of mesh has been enabled.	An object named "NAME" has a mesh with shape keys. This mesh has the "Relative" property enabled which is forbidden.
Object "NAME" has no data or data is broken. Change object type to EMPTY.	An object named "NAME" has no mesh or mesh is broken. The object's type has been changed to EMPTY.
Packed media "FILE_NAME" has not been exported to "CONVERTED_FILE_PATH"	The packed media file "FILE_NAME" cannot be converted to "CONVERTED_FILE_PATH". Please unpack this file and convert it.

Particle system error for “NAME”; The “NAME” vertex color specified in the from field is missing in the last of the “OBJECT_NAME” object’s vertex colors	The NAME vertex color is specified in the from field but it’s not presented in the OBJECT_NAME emitter.
Particle system error for “NAME”; The “NAME” vertex color specified in the to field is missing in the list of the “OBJECT_NAME” object’s vertex colors	The NAME vertex color is specified in the to field but it is not present in the OBJECT_NAME object which is selected as a particle.
Particle system error for “NAME”; The “NAME” vertex color specified in the “to field is missing in the “OBJECT_NAME” object (“GROUP_NAME” dupli group)	The NAME vertex color is specified in the to field but it is not present in the OBJECT_NAME object of the GROUP_NAME group which is selected as a particle.
Particle system error for object “NAME”. Invalid dupli object “OBJECT_NAME”.	Particle system error for the object NAME. Invalid dupli-object OBJECT_NAME.
Particle system error. Unsupported render type “TYPE” for the HAIR particles “NAME” on object “OBJECT_NAME”. Particle system removed.	Particle system error. Unsupported render type TYPE for the HAIR particles PSYS_NAME on object NAME. The particle system has removed.
Particle system error. Unsupported render type “TYPE” for the EMITTER particles “NAME” on object “OBJECT_NAME”. Particle system removed.	Particle system error. Unsupported render type TYPE for the EMITTER particles PSYS_NAME on object NAME. The particle system has removed.
Particle system error for “NAME”. Dupli object isn’t specified.	Particle system error: no object is selected as a particle.
Particle system error for “NAME”. Dupli group isn’t specified.	Particle system error: no group is selected as a particle.
Particle system error for “NAME”. Wrong dupli object type “TYPE”.	An object of unsuitable type is selected for the particle. Supported types: MESH.
Particle system error for “NAME”. Dupli object “NAME” has not been exported.	The NAME object which is selected as a particle can not be exported (the Do not export checkbox is set).
Particle system error for “NAME”. The “GROUP_NAME” dupli group contains no valid object for export.	The GROUP_NAME dupli group which is selected as a particle contains no valid object for export. Either such objects have the Do not export checkbox enabled or the types of the objects are unsuitable. Supported object types: MESH.
Sound file is missing in the SPEAKER object “NAME”. Converted to EMPTY.	The speaker has no sound attached. The object’s type has been changed to EMPTY.
The lamp object “NAME” has unsupported AREA type. Changed to SUN.	The lamp object “NAME” has unsupported AREA type. Lamp type has been changed to SUN.

The main scene NAME can not be rendered by another scene. Material NAME has been removed.	The main scene NAME can not be rendered by another scene. The material NAME has been deleted.
The NAME action has decimal frames. Converted to integer.	The NAME action has decimal frames, which isn't supported. Converted to integer.
The NAME armature modifier has a proxy object as an armature. Modifier removed.	An armature modifier has a proxy object as an armature.
The NAME armature modifier has no armature object or it is not exported. Modifier removed.	The NAME Armature modifier has no armature object or it is not exported. Modifier removed.
The NAME curve modifier has no curve object. Modifier removed.	The NAME curve modifier has no object. Modifier removed.
The NAME curve modifier has unsupported curve object. Modifier removed.	The NAME curve modifier has unsupported object. Modifier removed.
The NAME object has the NAME armature modifier and a vertex animation. Modifier removed.	The NAME object has both vertex animation and an armature modifier which is not supported. As a result, the modifier has been removed.
The NAME object has the NAME armature modifier. It belongs to a not exported scene. Modifier removed.	The NAME object has the NAME armature modifier. The armature object in this modifier isn't specified or belongs to a not exported scene. Modifier removed.
The NAME LAMP node has no lamp object. Material: NAME.	Wrong object specified in the NAME LAMP node.
The NAME node is not supported. The NAME material will be rendered without nodes. Material: NAME.	The engine does not support the node with this name, and so the node material will be turned off. Often this happens when Cycles nodes are used.
The NAME object has NAME armature modifier which references the wrong group. Modifier removed.	An object should be in the same group as an armature, or both these objects should be explicitly present in the scene.
"TEXTURE_TYPE" texture type is not supported for world "NAME".	TEXTURE_TYPE texture type isn't supported for world WORLD_NAME
Using B4W_REFRACTION node NODE_NAME with incorrect type of Alpha Blend. Material: NAME.	A node material with incorrect Alpha Blend property is used. Alpha sort, Alpha blend and Add are allowed when using a "REFRACTION" node.
Wind bending: not all vertex colors exist for "NAME". Properties were set to default values.	Wind bending parameters setup: all specified vertex color layers should exist.

Wind bending: vertex colors weren't properly assigned for "NAME". Properties were set to default values.	Wind bending parameters setup: it's required to specify the names of either all vertex color layers (Main stiffness (A), Leaves stiffness (R), Leaves phase (G), Overall stiffness (B)), or of the main one only (Main stiffness (A)), or of none of them.
Wrong "Height Map" input for the "NAME" B4W_PARALLAX node. Only link from the TEXTURE node with a non-empty texture is allowed.	Wrong data were passed to the "Height Map" input of the NAME B4W_PARALLAX node. Only the output from a non-empty TEXTURE node is allowed.
Wrong texture coordinates type in texture NAME. [Material: NAME.]	The following coordinate types are supported for image textures: UV, Normal and Generated.
Wrong F-Curve interpolation mode for ACTION_NAME. Only BEZIER, LINEAR or CONSTANT mode is allowed for F-Curve interpolation. Switch to BEZIER.	The following types are supported for action interpolation mode: BEZIER, LINEAR and CONSTANT.
Wrong vertex animation vertices count for mesh NAME. It doesn't match with the mesh vertices count for "ANIM_NAME".	Vertex animation export is enabled but the number of vertices in the baked ANIM_NAME animation frames does not match the mesh vertices number. Possible solution is to "re-bake" the animation.

Other Messages

These messages can be viewed in the browser console (opens with F12) when a scene is loaded. The message looks like this:

B4W EXPORT WARNING: Export message which requires the user's attention

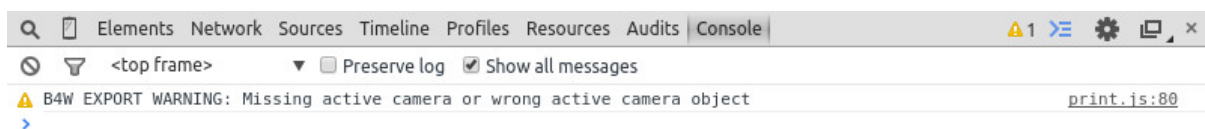

Error Message	Cause
Material tangent shading is enabled, but object's mesh has no UV map.	The material has the option "Tangent Shading" enabled, which always requires a UV map.
Missing active camera or wrong active camera object	There is no active camera on the scene (Camera property on the Scene tab).
Missing world or wrong active world object	There should be at least one world datablock in the scene.
Multiple constraints added on an object "Cube", but it supports only one. Others won't be used.	Multiple constraints added on an object NAME, but it supports only one. Others won't be used. The engine currently doesn't support multiple constraints on an object.
NAME particle settings has the NAME texture rendering a scene. It has been replaced by the default texture.	The particle settings datablock NAME contains the texture NAME being used for rendering a scene into. This texture has been replaced by a default texture.
The action NAME has no fcurves.	The action with the name "NAME" has no fcurves.
The "NAME" camera has unsupported PANORAMIC type. Changed to PERSPECTIVE type."	Panoramic cameras are not supported. Perspective mode is used instead.
Unsupported texture type or texture is missing for Lens Flare material "NAME"	There are no textures on the material or unsupported texture type is used for material "NAME".
Use of ENVIRONMENT_MAP as diffuse color is not supported. Use as mirror instead.	The ENVIRONMENT MAP texture can not be used as diffuse color. Disable the Diffuse > Color and enable the Shading > Mirror option on the Textures > Influence panel to use this texture as mirror map.

Add-on Translations

There is the possibility to translate the add-on to a language supported by Blender. In order to do this, rename the file "empty.po", which located in the directory SDK/blender_scripts/addons/blend4web/locales, to one of the names in the following table:

File name	Language
ru_RU.po	Russian
ja_JP.po	Japanese
en_US.po	English
Continued on next page	

Table 9.1 – continued from previous page

File name	Language
nl_NL.po	Dutch
it_IT.po	Italian
de_DE.po	German
fi_FI.po	Finnish
sv_SE.po	Swedish
fr_FR.po	French
es.po	Spanish
ca_AD.po	Catalan
cs_CZ.po	Czech
pt_PT.po	Portuguese
zh_CN.po	Simplified Chinese
zh_TW.po	Traditional Chinese
hr_HR.po	Croatian
sr_RS.po	Serbian
uk_UA.po	Ukrainian
pl_PL.po	Polish
ro_RO.po	Romanian
ar_EG.po	Arabic
bg_BG.po	Bulgarian
el_GR.po	Greek
ko_KR.po	Korean
ne_NP.po	Nepali
fa_IR.po	Persian
id_ID.po	Indonesian
sr_RS@latin.po	Serbian Latin
ky_KG.po	Kyrgyz
tr_TR.po	Turkish
hu_HU.po	Hungarian
pt_BR.po	Brazilian Portuguese
he_IL.po	Hebrew
et_EE.po	Estonian
eo.po	Esperanto
es_ES.po	Spanish from Spain
am_ET.po	Amharic
uz_UZ.po	Uzbek
uz_UZ@cyrillic.po	Uzbek Cyrillic
hi_IN.po	Hindi
vi_VN.po	Vietnamese

Then open this file and edit/translate it.

When translations are ready, you may contact us to include them as part of the add-on.

Scene Settings

Table of Content

- Scene Settings
 - Render Panel
 - * Development Tools
 - * Shading
 - * Shadows
 - * Reflections and Refractions
 - * Object Outlining
 - * Glow Materials
 - * Anti-Aliasing
 - * Anisotropic Filtering
 - * Bloom
 - * Motion Blur
 - * Ambient Occlusion (SSAO)
 - * God Rays
 - * Color Correction
 - * Timeline
 - * Dynamic Grass
 - Scene Panel
 - * Scene
 - * Units
 - * Audio
 - * Logic Editor
 - * NLA
 - * Meta Tags
 - * Physics
 - * Object Clustering & LOD
 - * Object Selection
 - * Anchors
 - * Export Options
 - World Panel
 - * Preview
 - * World
 - * Environment Lighting
 - * Mist
 - * Procedural Sky
 - * Animation
 - * Export Options

All the parameters that define the look and behavior of the whole scene (and not just a single object) are found on the three panels: the Render panel, the Scene panel and the World panel.

Render Panel

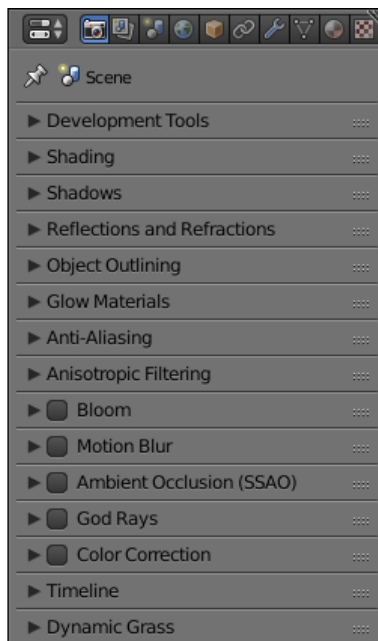

All scene parameters that concern the image rendering are found on this panel.

Development Tools

Development Server settings. Described thoroughly in [its own section](#).



Shading

This panel contains various shading options.



Set Recommended Options This button is used to achieve maximum consistency between

the look of a 3D scene in Blender viewport and in web browser. Pressing this button:

- enables World Space Shading,
- switches material mode to GLSL,
- switches viewport shading mode to Material and
- sets the main camera fit to Vertical.

World Space Shading This option turns on and off World Space Shading (world space interpretation of lighting data will be used for object shading). Disabled by default.

Shadows

Shadows settings. Described thoroughly in its own section.



Reflections and Refractions

Reflection and refraction effect settings.

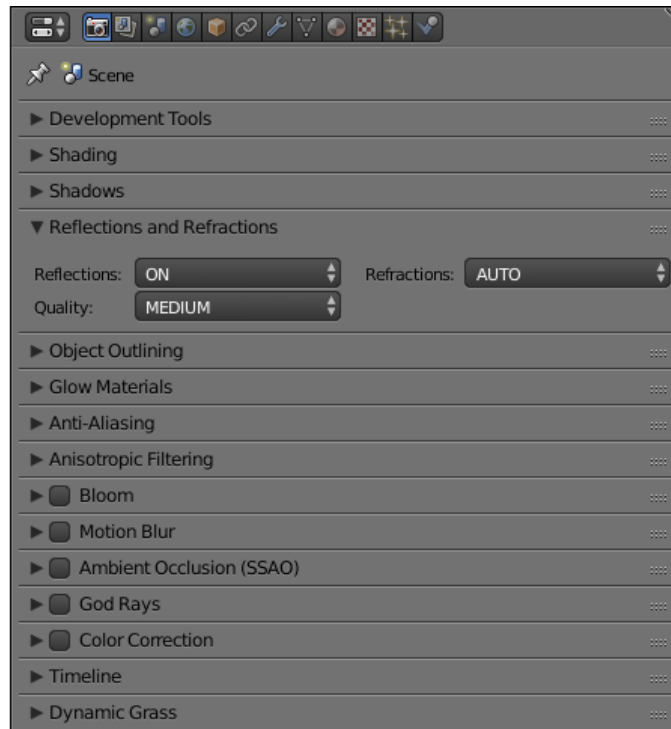

Reflection Reflection effect settings. Can be set to ON, OFF or AUTO. Set to ON by default.

Refraction Refraction effect settings. Can be set to ON, OFF or AUTO. Set to AUTO by default.

Quality Quality settings for the reflection effect. Can be set to HIGH (the highest reflection quality), MEDIUM (medium quality) or to LOW (the lowest quality). Set to MEDIUM by default.

Object Outlining

Outlining effect settings. Described thoroughly in its own section.



Glow Materials

Glow Material effect settings. Described thoroughly in its own section.



Note: For dynamically loaded objects, AUTO setting is interpreted as OFF, if no materials with glow are present in the scene. If you are using dynamic loading, you should set this parameter to ON.

Anti-Aliasing

Anti-Aliasing settings. Described thoroughly in [its own section](#).

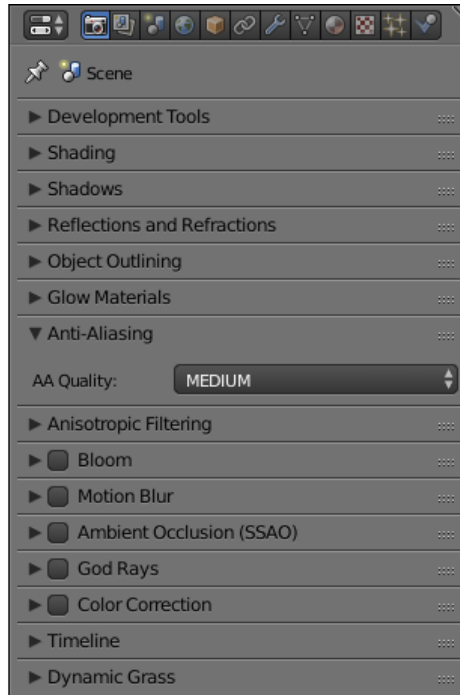

Anisotropic Filtering

This parameter can be used to enable or disable anisotropic filtering and also to set the number of texture samples used for it. By default, anisotropic filtering is disabled.

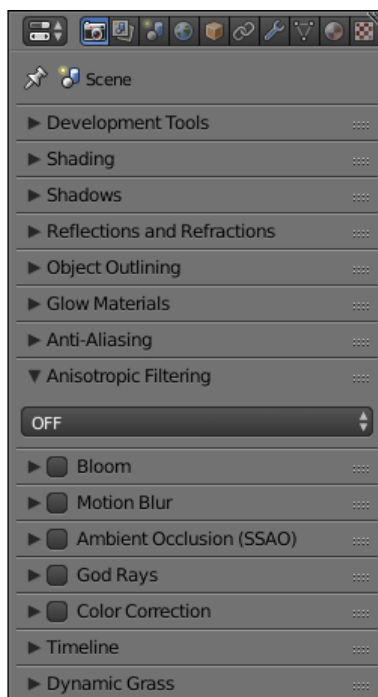

Available values: 16x, 8x, 4x, 2x and OFF (default value).

Bloom

Bloom effect settings. Described thoroughly in its own section.

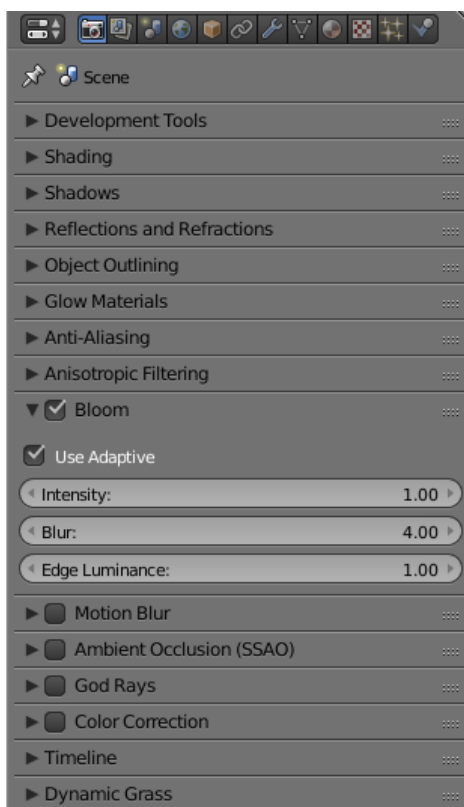

Motion Blur

Motion blur settings. Described thoroughly in its own section.

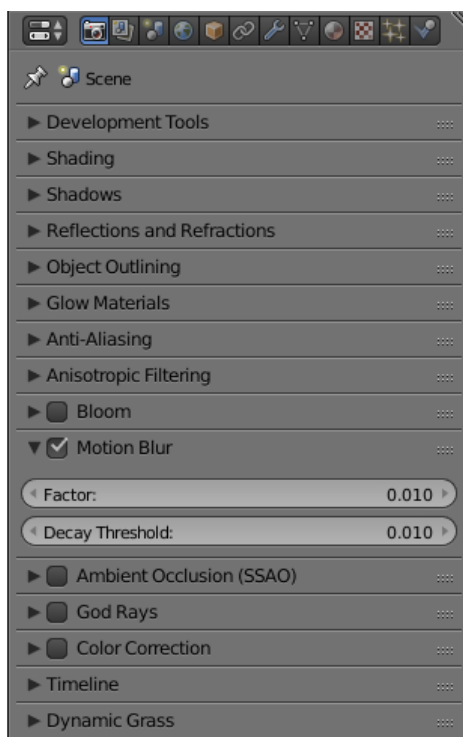

Ambient Occlusion (SSAO)

Screen-space ambient occlusion (SSAO) settings. Described thoroughly in its own section.

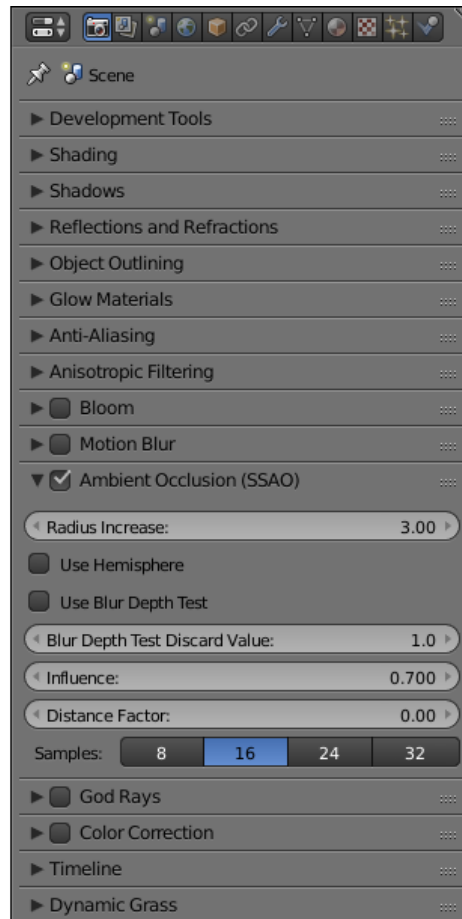

God Rays

God Rays effect settings. Described thoroughly in [its own section](#).

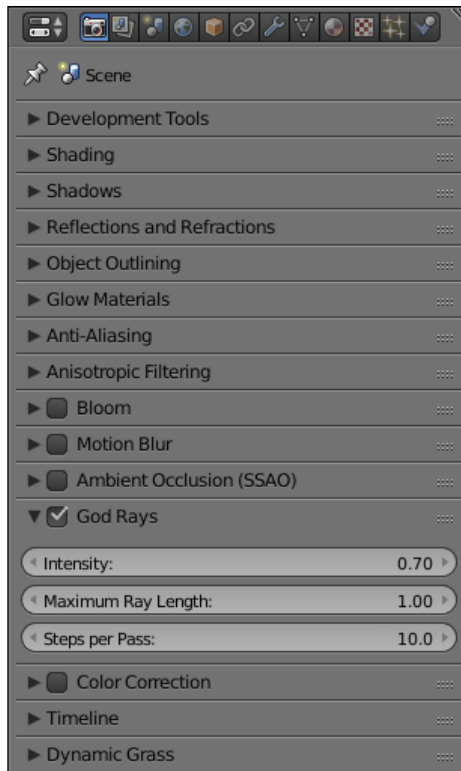

Color Correction

Color correction settings. Described thoroughly in its own section.

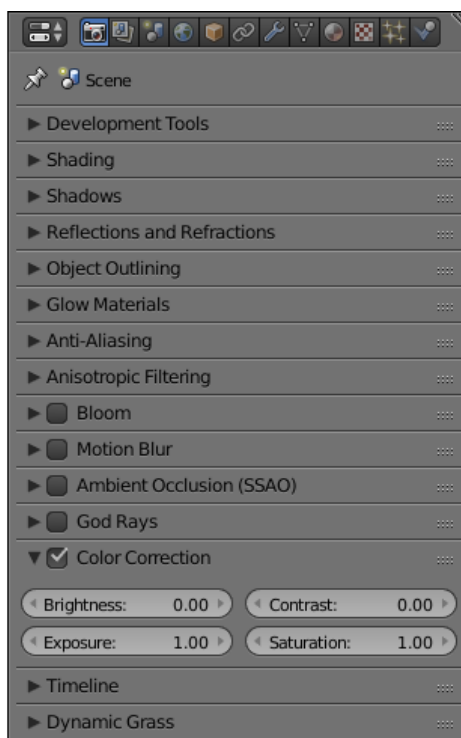

Timeline

Timeline settings.

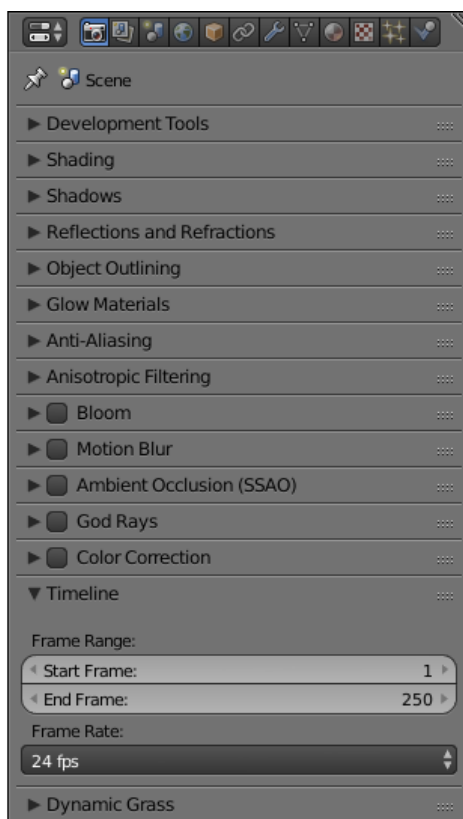

Start Frame The first frame of the timeline. Set to 1 by default.

End Frame The last frame of the timeline. Set to 250 by default.

Frame Rate Number of the frames per second. Set to 24 by default. This parameter only affect the animation playback speed (not the scene itself).

Dynamic Grass

Enables and disables [dynamic grass](#) effect.

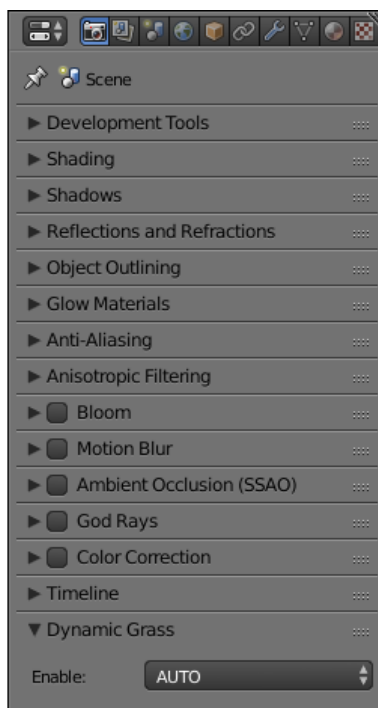

Possible values: ON, OFF and AUTO. Set to AUTO by default.

Scene Panel

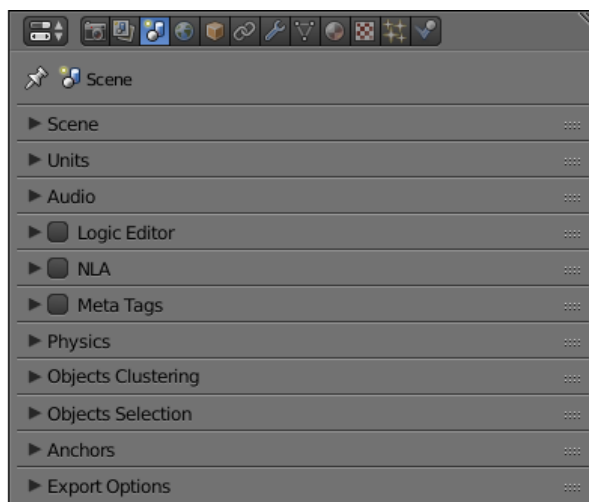

The settings that concern scene behavior, including audio, physics and animation settings, are found on this panel.

Scene

Scene settings.

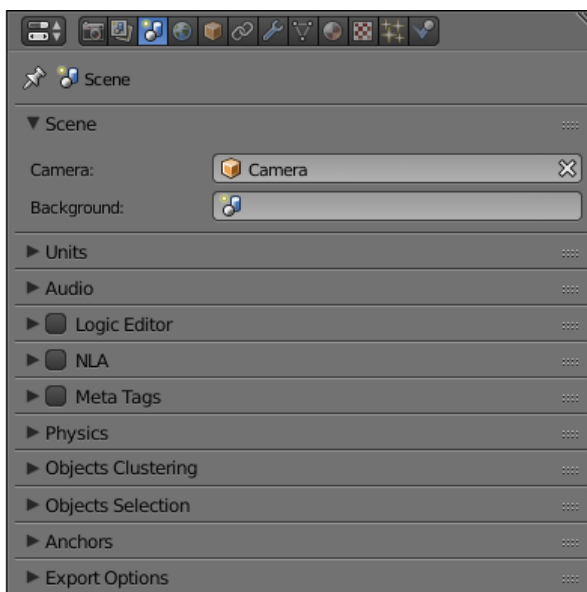

Camera A camera that is used to render the scene.

Units

Sets the measurement units used in the scene.

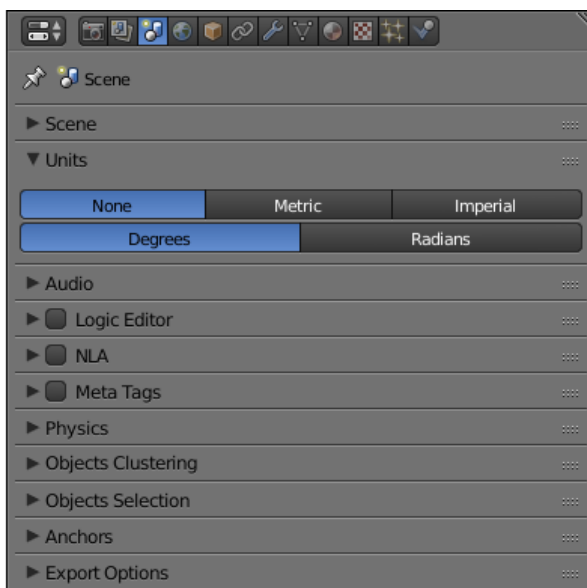

Audio

Audio settings.

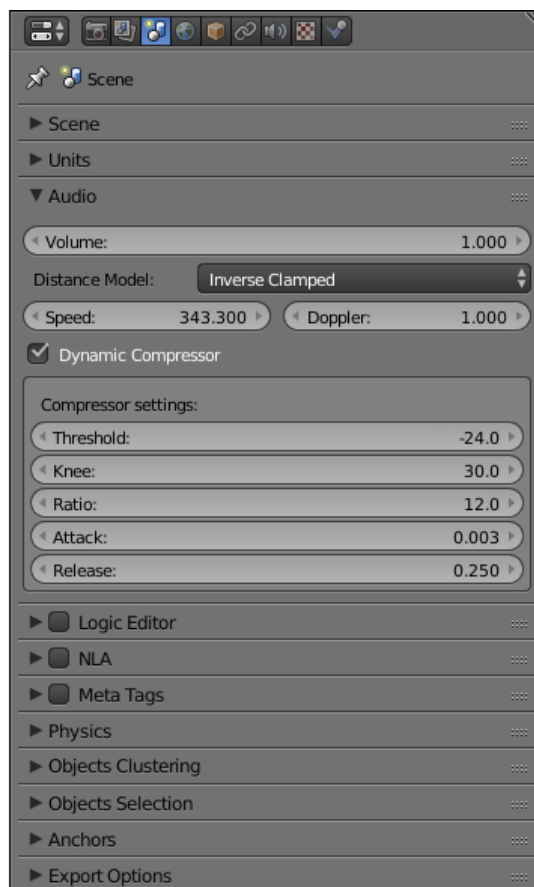

Volume The master volume of the sound in the application. This value can vary between 0 and 100. Default value is 1.0.

Distance Model The distance model used for calculating distance attenuation. Following models are supported by the engine:

None - no distance model is used, the sound has constant volume regardless of the distance.

Exponent Clamped - a clamped exponential distance model.

Linear Clamped - a clamped linear distance model.

Inverse Clamped - a clamped inverse distance model.

The following models are partially supported (work the same way the corresponding Clamped-type models):

Exponent

Linear

Inverse

This parameter is set to Inverse Clamped by default.

Speed This parameter sets the speed of sound used for Doppler effect calculation. Its value is measured in meters per second and is set to 343.3 by default.

Doppler This sets the pitch factor for Doppler effect calculation. Its default value is 1.0.

Dynamic Compressor Compress audio signal's dynamic range. This feature can be used to make the sound more rich and even. Disabled by default.

Threshold If the amplitude of the audio signal exceeds the value specified by this parameter, the compressor will reduce its level. Set to -24 dB by default.

Knee The interval below the threshold where the response curve switches to the decreasing mode. Set to 30 by default.

Ratio Amount of gain reduction. Set to 12 by default.

Attack Time (in seconds) that takes the compressor to reduce gain by 10 dB. Set to 0.003 by default.

Release Time (in seconds) that takes the compressor to increase gain by 10 dB. Set to 0.25 by default.

Logic Editor

Settings for the use of the logic node trees (created in the [logic editor](#)) in the scene. Disabled by default.

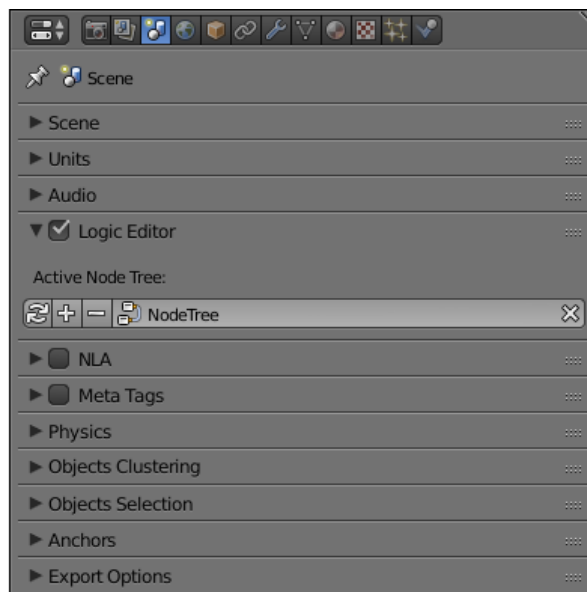

Active Node Tree Node tree that is used in the scene's playback.

NLA

Non-Linear Animation playback settings. Disabled by default.

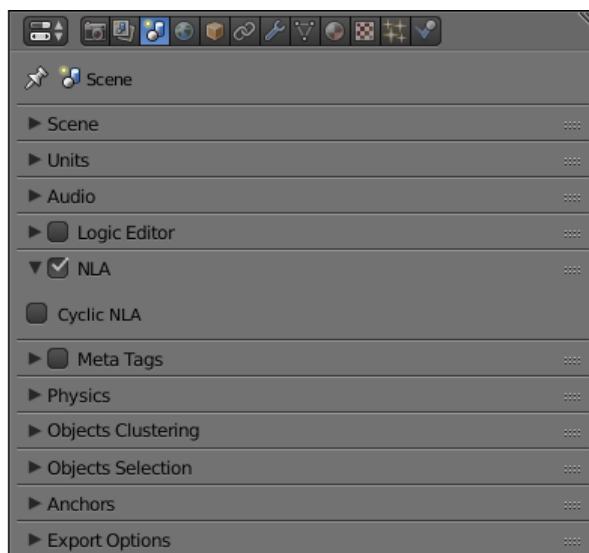

Cyclic NLA If this parameter is enabled, NLA animation will be repeated after it is finished.

Meta Tags

Application's meta tags. Can be set up in the same way as [object meta tags](#).

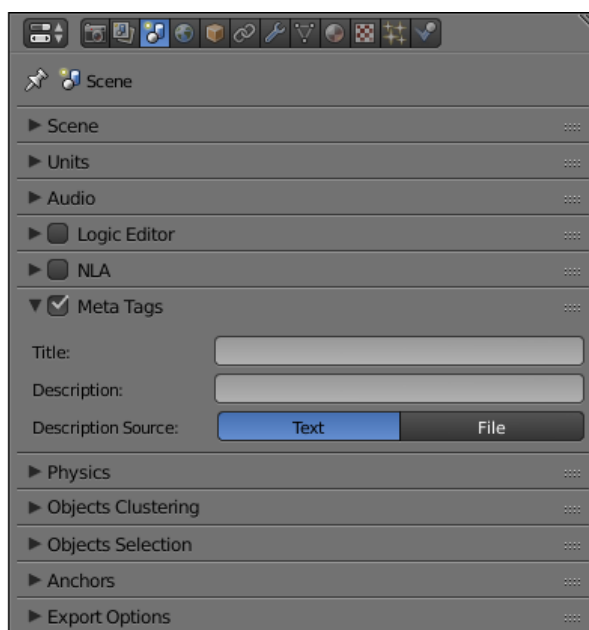

Title The title of the application.

Description The description of the application. Can be a simple text or a link to a text file (if the Description Source parameter is set to the File value).

Note: If you are using a text file as description source, said file can be imported to Blender using a built-in [Text Editor](#).

Description Source The source of the application's description. The description can be loaded from a file or specified directly in the Description field. This parameter can have one of the two values, Text and File, and it is set to Text by default.

Physics

Physics settings.

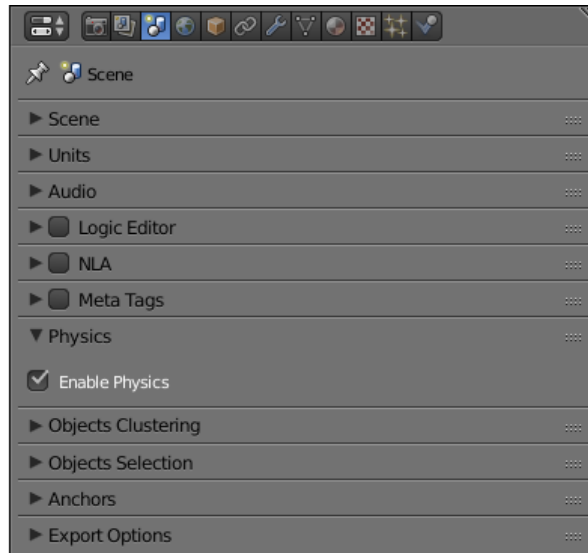

Enable Physics Allow using physics in the application. Enabled by default.

Object Clustering & LOD

Settings for object clustering and Levels Of Detail.

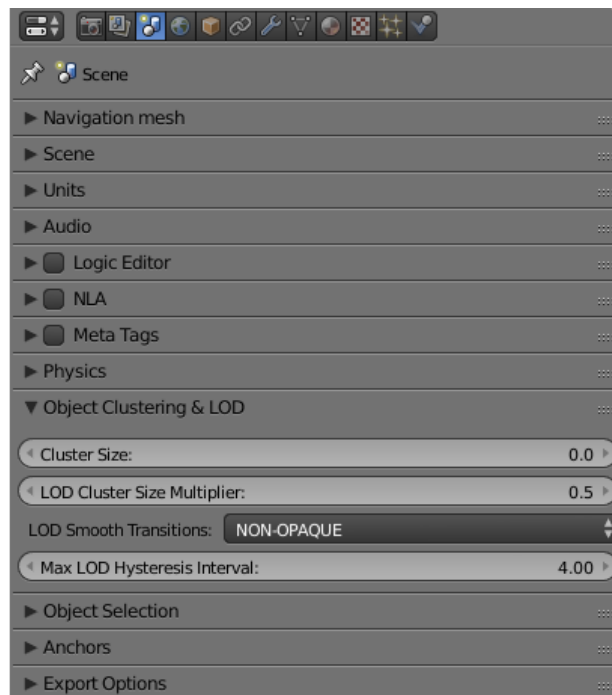

Cluster Size The size of the cluster used for batching (in meters). Can be used for optimization purposes. If this parameter is set to zero, the engine will try to combine all objects in the scene. Set to zero by default.

LOD Cluster Size Multiplier This parameter is used to subdivide clusters (based on LOD distance specified individually for each object) into smaller ones to make transitions between different levels of detail less noticeable. The size of that smaller clusters is defined by object LOD distance multiplied by the value of this parameter. Higher values lead to bigger clusters which increases performance but makes transition between LODs more noticeable, while lower values make said transitions less noticeable at the cost of decreased performance. Can be used for optimization purposes. Set to 0.5 by default.

LOD Smooth Transitions Defines what objects will use smooth transitions while switching their LOD levels. Has the following options:

- OFF - smooth transitions are disabled (fastest).
- NON-OPAQUE - use smooth transitions for objects with Add, Alpha Clip, Alpha Blend, Alpha Sort and Alpha Anti-Aliasing materials.
- ALL - smooth transitions will be used for all objects (slowest).

Choosing the “ALL” value can noticeably decrease application performance, so use it with caution. Default value is “NON-OPAQUE”.

Max LOD Hysteresis Interval

The length of the interval (in meters) used for switching LOD levels. The half of this value is added/subtracted from the distance threshold in order to make two different thresholds for switching to the lower and to the higher LOD level. This should reduce LOD “popping” effect. Set to 4.0 by default.

Object Selection

Object selection settings. Objects can be selected both with the API function `pick_object()` and with the [logic nodes](#).

Note: In the [scene viewer](#), selection is enabled by default. You can turn it off in the Tools & Debug panel.

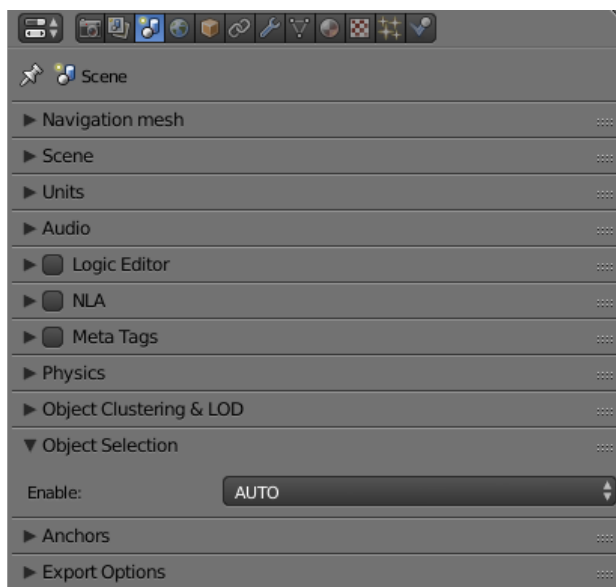

Enable The parameter that defines if the object can or can't be selected. It can have ON, OFF or AUTO value. Set to AUTO by default.

Anchors

Anchor visibility detection settings.

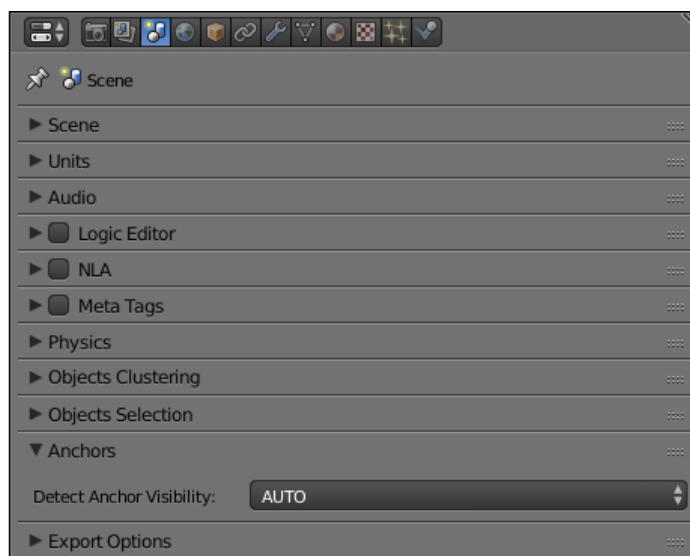

Detect Anchors Visibility Anchor visibility detection parameter. Can have ON, OFF or AUTO value. Set to AUTO by default.

Export Options

Scene settings export parameters.

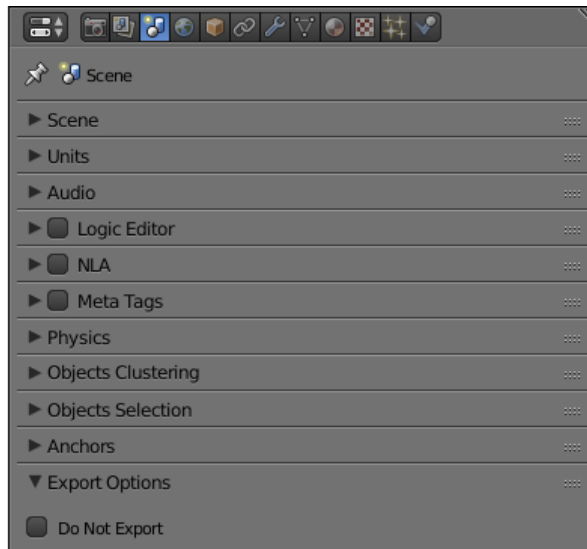

Do Not Export If this parameter is enabled, scene settings will be ignored during export.

World Panel

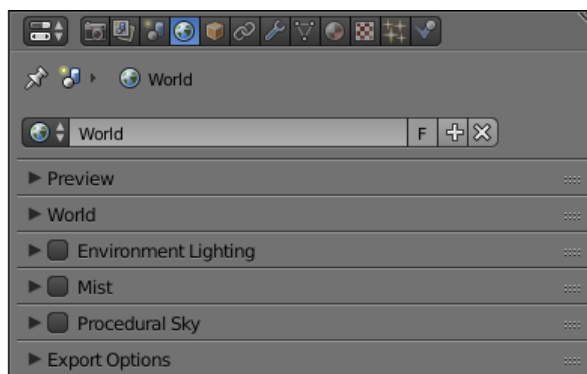

Environment settings such as settings for sky, mist and such are found on this panel.

Preview

Environment preview.

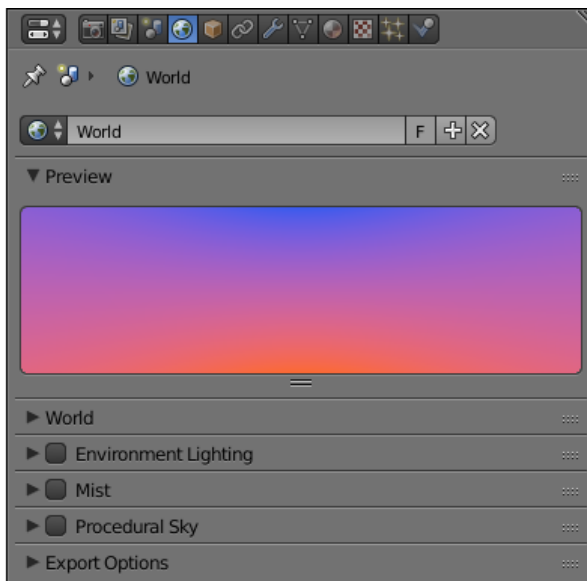

World

Sky settings.

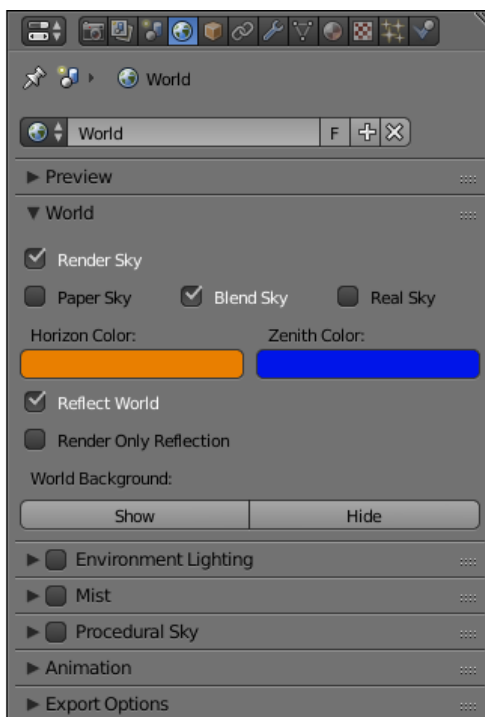

Render Sky If this parameter is enabled, the engine will render sky in the scene.

Paper Sky If this parameter is enabled, sky gradient will always be drawn from the top of the screen to the bottom, regardless of the camera's position and angles.

Blend Sky Smooth transition between the horizon and zenith colors.

Real Sky Sky rendering with the horizon affected by the camera angle.

Horizon Color Sky color at the horizon.

Zenith Color Sky color in the zenith.

Reflect World Render the sky while rendering reflections.

Render Only Reflection Render the sky only while rendering reflections.

World Background Enables and disables World Background option (located under the Display tab of the 3D View panel). When this option is activated, background colors are rendered in the viewport window the same way they would be in the engine itself.

Environment Lighting

Environment lighting settings. Described thoroughly in [their own section](#).

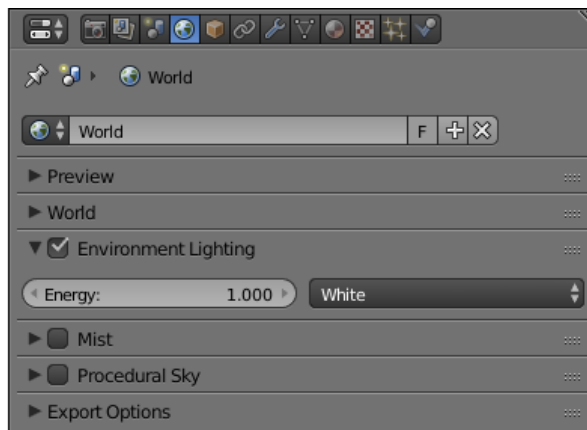

Mist

Mist settings.

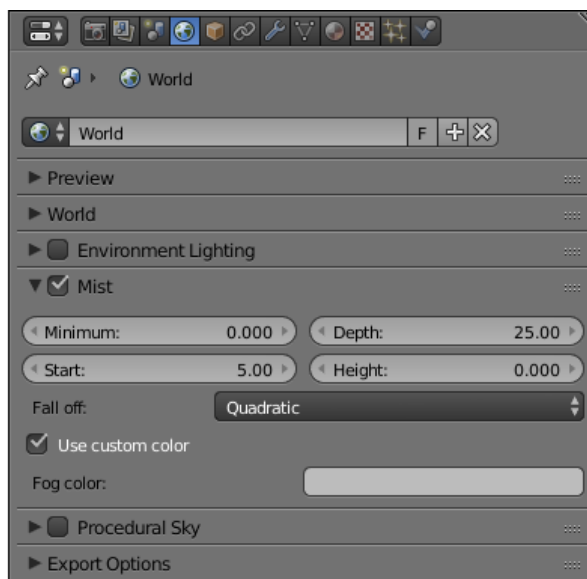

Minimum Minimum intensity of the mist. Set to zero by default.

Depth At this distance from the camera the mist effect reaches maximum intensity. Set to 25 by default.

Start The mist effect starts to appear at this distance from the camera. Set to 5 by default.

Height This parameter specifies how fast mist intensity decreases as the camera's altitude increases. Set to 0 by default.

Fall Out This parameter specifies the rule, according to which the density of the mist changes between the borders (specified by the Start and Depth parameters). Can have one of the following values: Quadratic, Linear, Inverse Quadratic. Set to Quadratic by default.

Use Custom Colors Can be used to set the color of the mist. Enabled by default. If this parameter is disabled, standard (0.5, 0.5, 0.5) color will be used.

Fog Color The color of the mist. Can be changed, if the Use custom colors parameter is enabled. Light gray (0.5, 0.5, 0.5) color is used by default.

Procedural Sky

Procedural sky settings. Described thoroughly in [their own section](#).



Animation

Environment animation settings.



Apply Default Animation If this parameter is enabled, the engine will start playback of the animation assigned to the environment upon loading.

Behavior Sets the behavior of the default animation. Available options are:

- Loop - the animation will be played repeatedly.
- Finish Stop - the animation will be played once.
- Finish Reset - the animation will be played once, and then switched back to the first frame.

This option is only available if the Apply Default Animation parameter is enabled.

Export Options

Environment parameters export settings.

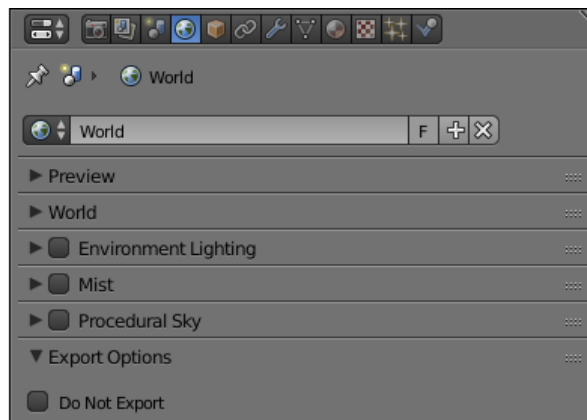

Do Not Export If this parameter is enabled, environment settings will be ignored during the export.

Objects

Table of Contents

- Objects
 - Types
 - Static and Dynamic Objects
 - Settings
 - * Object Tab
 - * Physics Tab
 - Object Constraints
 - Anchor Settings
 - Object Transform API
 - Get Object API
 - Object Selection
 - Copying Objects (Instancing)
 - * Making a Simple Copy
 - * Making a Deep Copy
 - * Removing Objects
 - Quaternions
 - * Quaternion Example
 - Moving via TSR Vectors
 - Line Rendering
 - Levels Of Detail
 - * Overview
 - * Specifics and Differences From BGE
 - * Smooth LOD Switching
 - * Hysteresis

Objects are intended to position components of different types (meshes, cameras, lamps etc) in a 3D scene space.

Types

The engine supports objects of the following types:

- meshes (mesh)
- camera
- lamp
- empty
- armature
- speaker
- curve
- text
- metaball
- surface

During the scene export, CURVE, TEXT, METABALL and SURFACE type objects are converted into MESH type objects.

Static and Dynamic Objects

An object can be either static or dynamic.

Static objects are objects that cannot be moved, animated or changed in any other way while running the application. For performance purposes, such objects can be merged together if they have the same material.

Dynamic objects can be moved, animated or changed in other ways while running the application. They can also interact with other objects, including static ones. Dynamic objects are never combined with each other or with static objects.

Only MESH and EMPTY type objects can be either static or dynamic. All other object types, such as CAMERA and ARMATURE, are always dynamic.

Static MESH objects are rendered much faster than the dynamic ones, so, for better performance, it is advised to keep the number of dynamic meshes to a minimum. Objects of any other type, both static and dynamic, do not significantly affect performance.

The objects which have animation, physics or a parent, which is a dynamic object, are considered dynamic, as well as the objects controlled by the following logic nodes:

- Play Animation
- Transform Object
- Move To
- Inherit Material

API methods that concern object movement, copying and animation (both object and node material) can only be applied to dynamic objects. In order to make the movement of the object without dynamic settings possible, it is necessary to activate Force Dynamic Object option in its settings.

Settings

The following is supported for all types of objects: transform, data reference, parent object, group membership and a set of the Blend4Web's special properties.

Object Tab

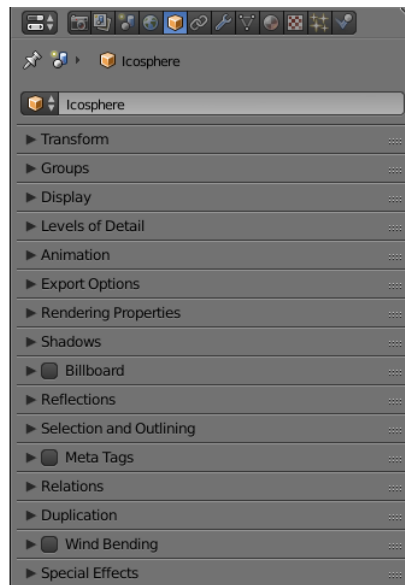

Transform Panel

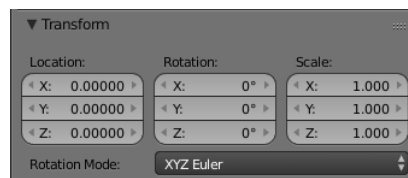

Transform > Location Position coordinates.

Transform > Rotation Rotation angles. For the object rotation all available modes can be used (Rotation Mode). However only Quaternion (WXYZ) and XYZ Euler are supported for [object animation](#).

Transform > Scale Scaling. All 3 components (x, y, z) should be the same. Scaling for physics objects is not supported.

Groups Panel

Groups Objects' groups to which this object belongs.



Display Panel

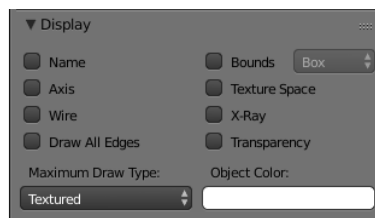

This panel contains parameters that define how the selected object looks in the 3D View window. It does not feature any additional options in Blend4Web mode.

Levels of Detail Panel

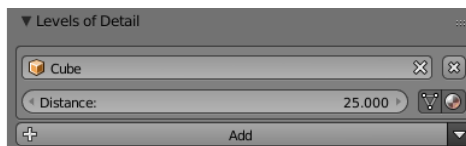

Levels of Detail > Object The object to use for this level of detail.

Levels of Detail > Distance The distance to begin using this level of detail.

Using levels of detail is described in the [dedicated section](#).

Animation Panel

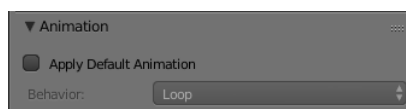

Animation > Apply Default Animation Upon loading into the engine start playback of the animation assigned to the object.

Animation > Animation Blending Only for armature objects. Allows blending between skeletal animations.

Animation > Behavior Animation behavior when the last frame is reached: Finish Stop - stop, Finish Reset - stop and go to the zero frame, Loop - repeat forever.

Export Options Panel

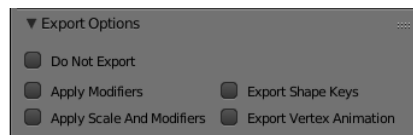

Export Options > Do Not Export Do not export this object.

Export Options > Apply Modifiers Apply the object's modifiers upon export.

Note: If the Skin modifier is used we recommend to apply it before the export because it resets vertex color and UV layers which may result in errors.

Export Options > Apply Scale and Modifiers Upon export, apply scale and modifiers for the object.

Export Options > Export Vertex Animation Export previously created and saved vertex animation. Applicable for MESH type objects only.

Export Options > Export Shape Keys Export shape keys. Applicable to MESH type objects only.

Note: The following properties are mutually exclusive: Apply Modifiers, Apply Scale and Modifiers, Export Vertex Animation and Export Shape Keys.

Rendering Properties Panel

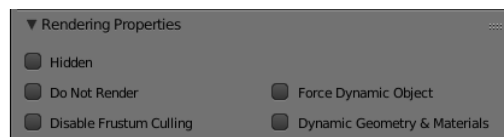

Rendering Properties > Hidden An object with this property enabled will be hidden on load.

Rendering Properties > Hidden Children All of the object's children and children's children and so on will be hidden on load. Available only if the Rendering Properties > Hidden property is enabled and if the object has any children.

Rendering Properties > Do Not Render Disable object rendering (for example useful for a physics object).

This parameter is not available for Empty type objects.

Rendering Properties > Disable Frustum Culling Disable frustum culling optimization.

This parameter is not available for Empty type objects.

Rendering Properties > Force Dynamic Object Force the object to become a [dynamic object](#).

Rendering Properties > Dynamic Geometry & Materials Allows using geometry update API and inherit materials for the object.

Rendering Properties > Line Rendering Enables using the object for rendering [lines](#).

This parameter is only available for Empty type objects.

Shadows Panel



Shadows > Cast The object will cast shadows.

Shadows > Cast Only The object will cast shadows but will remain invisible itself. Becomes available after enabling Shadows > Cast.

Shadows > Receive The object will receive shadows from other adjacent objects.

Billboard Panel

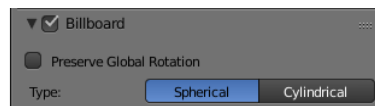

Billboard Use the object as a billboard (i.e. automatically orient relative to the camera).

Billboard > Preserve Global Rotation Take into account rotation of the billboard object (in the world space). The object will be directed toward the camera with its side which is visible when viewing along the Y axis in Blender. Becomes available after enabling the Billboard checkbox.

Billboard > Billboard Type Billboard orientation mode. Spherical (by default) - the object is always oriented with one side toward the camera, regardless of view angle, Cylindrical - similar to Spherical, but rotation is limited to Blender's world Z axis. Becomes available after enabling Billboard

Reflections Panel



Reflections > Reflexible When enabled the object is reflected in the dynamic mirror surfaces.

Reflections > Reflexible Only The object will be reflected but will remain invisible itself. Becomes available after enabling Reflections > Reflexible.

Note: If the Reflexible Only parameter is enabled simultaneously with the Shadows > Cast Only parameter, the engine will not render the object itself, but will render its shadow and reflection, like it is shown on the picture below.

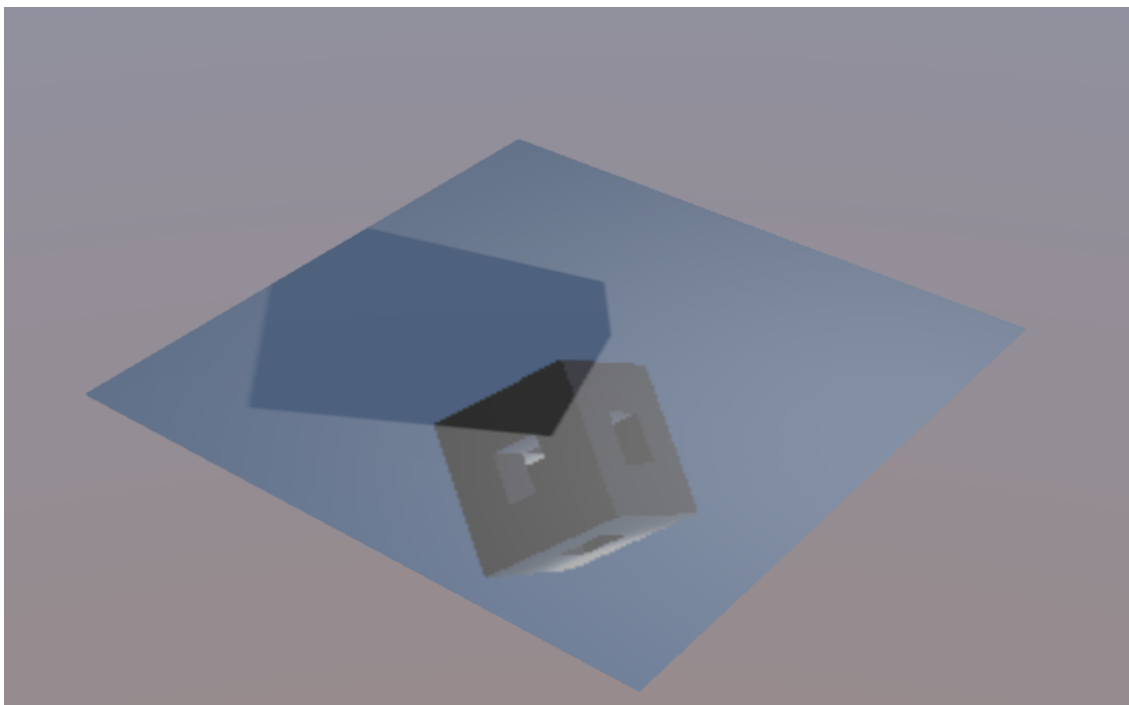

Reflections > Reflective When enabled the object surface reflects other objects.

Reflections > Reflection Plane Text field for name of an empty object which defines the reflection plane. Becomes available after enabling Reflections > Reflective.

Selection and Outlining Panel

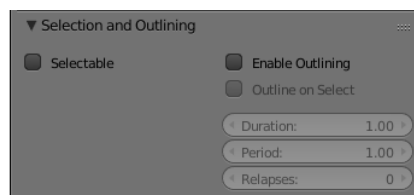

Selection and Outlining > Selectable Enable [object selection](#) with the mouse or another input device.

Selection and Outlining > Enable Outlining Enable [outline glow](#) for the object.

Anchors Panel

Anchors > Enable Anchor This parameter enables interface for adding anchors (2D tags) to objects. Available for EMPTY objects only. Described in the [corresponding section](#).

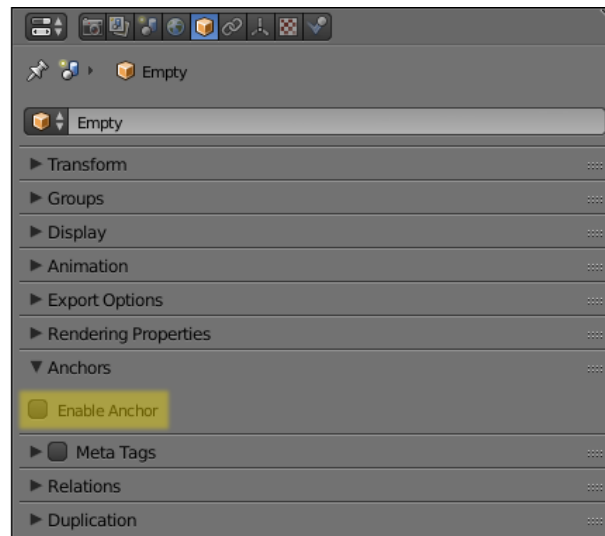

Meta Tags Panel

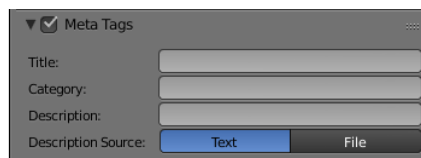

Meta Tags Interface for adding meta tags to the object:

Meta Tags > Title Object's title.

Meta Tags > Category Object's category.

Meta Tags > Description Description for the object. Depending on Description Source, this field accepts either description text itself, or the name of a file where this description is contained.

Note: To use a text file as a description source you first have to open an existing file in Blender [Text Editor](#) or to create a new text file in the same editor.

Then, you only have to set the name of the file in the Description field.

Meta Tags > Description Source Source type for the description: text or text file.

Relations Panel

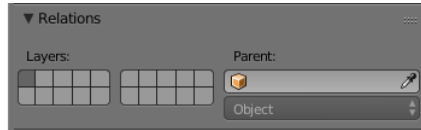

Relations > Parent Reference to the parent object.

If the parent object is a camera, Viewport Alignment settings are available.

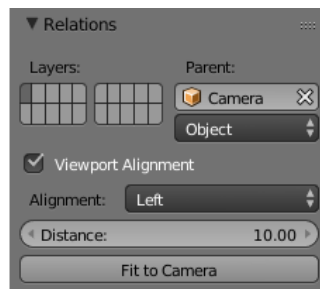

These settings can be used to align the object to an active camera. They are described in the [Camera](#) chapter.

Duplication Panel

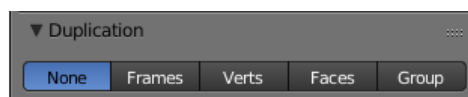

This panel contains settings that concern object duplication. It does not feature any additional parameters in the Blend4Web mode; however, it should be noted that at the moment Blend4Web engine only supports Group duplication method.

Wind Bending Panel

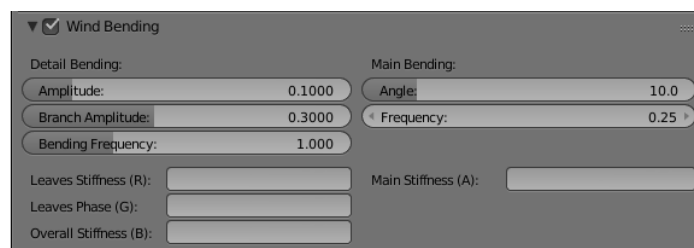

Wind Bending Enables wind bending procedural animation. Thoroughly described at the [outdoor rendering](#) page.

Special Effects Panel

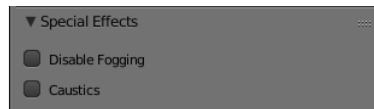

Special Effects > Disable Fogging Disable fog for the object.

Special Effects > Caustics The object will render caustics effects from the adjacent water.

Physics Tab

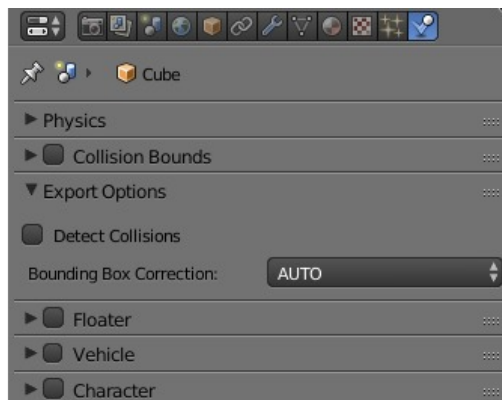

Detect Collisions Activate the object's physics.

Floating Make the object floating. The settings for floating objects are described in detail in the [physics](#) section.

Vehicle Use the object as part of a vehicle. The vehicle settings are described in detail in the [physics](#) section.

Character Use the object for character physics. The character settings are described in detail in the [physics](#) section.

Object Constraints

Blend4Web engine supports the following object constraints:

- Copy Location,
- Copy Rotation,

- Copy Transforms and
- Track To.

Note: When object constraints are used in Blend4Web, the Space parameter is not taken into account (it is always set to World Space).

These constraints can be set up directly in Blender. Other types of constraints are not currently supported, but some API methods from the `constraints` module act similarly. This include:

- the Copy Location constraint can be emulated with the `append_copy_loc()`
- the Copy Rotation constraint works similarly to the `append_copy_rot()` method.
- the Copy Transforms constraint works similarly to the `append_copy_trans()` method.
- The Limit Distance constraint can be emulated with the `append_follow()` method, though it should be noted that this method does not set a precise distance between objects (instead, it set a minimum and maximum possible distances).
- the Track To constraint can be replaced with the `append_track()` method.

Other constraints do not have distinctive counterparts in the API, although their behavior can be to certain extent imitated using API methods.

The `constraints` module also includes several additional methods:

- `append_semi_soft()`

This method can be used to attach one object to another one using a semi-soft constraint. The object will smoothly follow the object's rear. This can be used to create third-person cameras.

- `append_semi_stiff()`

This method can be used to attach the object to the other object using a semi-stiff constraint, meaning that the child object will move and rotate together with its parent, but it will also be possible to rotate it independently in the parent's local space. A behavior similar to that of a tank turret can be created this way.

- `append_stiff()`

This method attaches the object to another object (or to an armature bone) using a stiff constraint. The child object will move, rotate and scale together with its parent.

Examples: a sword parented to the character's hand; a character sitting in a vehicle.

- `append_stiff_trans()`

This method attaches the object to the other object using a stiff translation constraint. The child object moves together with its parent, but does not rotate along with it (it, however, can be rotated independently from the parent).

- `append_stiff_trans_rot()`

Can be used to attach the object to another object using a stiff translation/rotation constraint. In this case, the child object moves and rotates along with its parent, but does not scale in accord with it. However, the object still can be scaled independently from the parent.

Example: a smoke emitter attached to the tractor pipe; exhaustion effects are achieved by scaling the emitter.

- `append_stiff_viewport()`

Attaches the object to the camera using a stiff viewport constraint (so the child object will preserve its orientation in the camera viewport).

This constraint can be used to create onscreen 2D/3D interfaces elements.

- `remove()` - this method removes any constraints that were previously applied to the object.

Anchor Settings

Anchors can be used to attach annotations to 3D objects. The annotation is displayed near the object regardless of the camera position and even follows it throughout the animation.

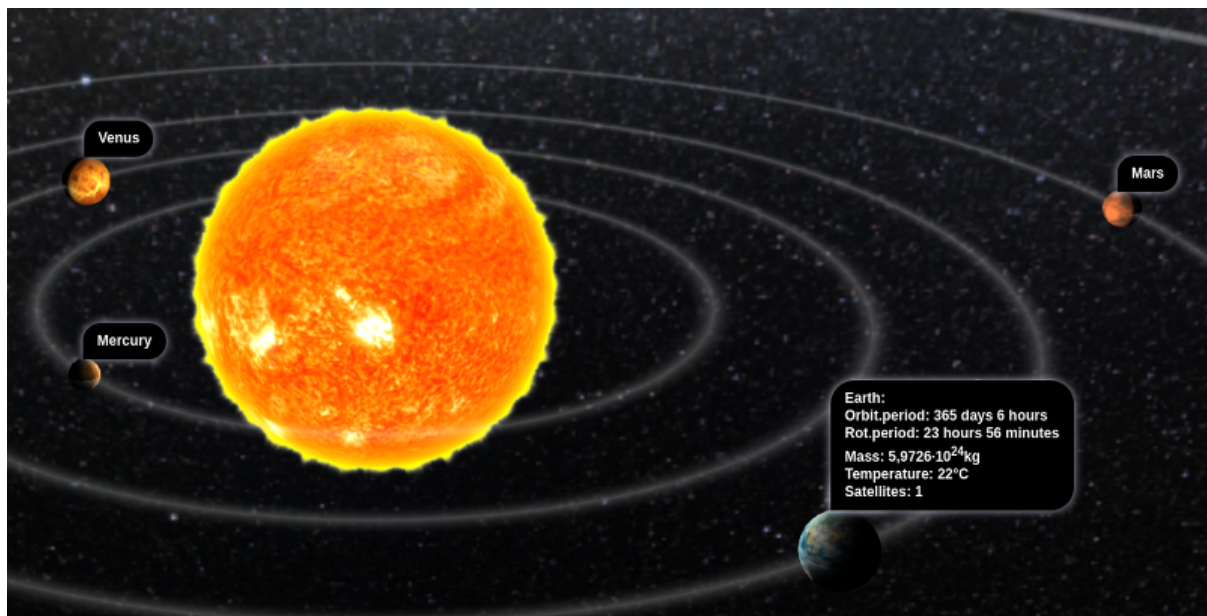

Annotations can be created entirely in Blender. All you need to do is to place an Empty object in the required position and enable the Anchor property. The text for the annotations can be assigned in the Title and Description fields on the Meta Tags panel.

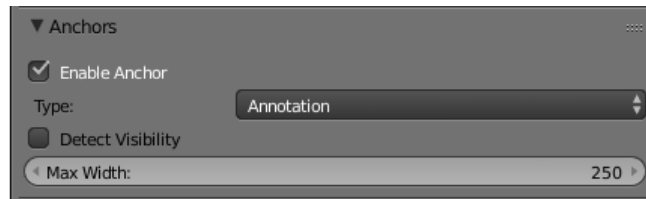

Enable Anchor This parameter enables the interface for adding anchors (2D tags) to objects. This is available for EMPTY objects only.

Type Anchor type

- **Annotation** - content is obtained from the [meta tags](#) assigned to the object and displayed in the standard section.
- **Custom Element** - an arbitrary HTML element from the current web page is used as an anchor.
- **Generic** - an anchor's position can be detected using the anchors API module.

Default value is Annotation.

HTML Element ID This specifies the ID of the HTML element that will be used as the anchor. This is available only if the Type parameter is set to Custom Element.

Detect Visibility Detect whether the anchor object is overlapped by other objects. This is disabled by default. Turning this option on decreases performance and should be used only when necessary.

Max Width This parameter limits the expanding info window by a predefined value (measured in CSS pixels). This is available only if the Type parameter is set to Annotation, and it is set to 250 by default.

Object Transform API

Note: Make sure that the object you are trying to transform is a [dynamic object](#).

Use the following methods of the [transform](#) module to move objects in the engine:

`get_translation()` Get the coordinates of the object's center in world space. The method with a single argument returns a new vector (i.e. this is a non-optimized option) while the method with two arguments requires an additional vector to write the result down.

`get_translation_rel()` Similar to the `get_translation()` method, but if this object has a parent, the obtained coordinates are measured in the parent's space.

`set_translation()`, `set_translation_v()` Move the object's center into the specified location. The first method takes separate coordinates as arguments while the second one takes a three-component vector (Array or Float32Array).

`set_translation_rel()`, `set_translation_rel_v()` Similar to `set_translation()` and `set_translation_v()`, but if this object has a parent, the set coordinates are measured in the parent's space.

`get_rotation()` Get the object's rotation quaternion in world space. Similar to `get_translation()`, there are two options for calling this function.

`get_rotation_rel()` Get the object's rotation quaternion measured in its parent's space. Similar to `get_translation_rel()`, there are two options for calling this function.

`set_rotation()`, `set_rotation_v()` Set the object's rotation quaternion in world space. The first function takes separate coordinates as arguments while the second one takes a four-component vector (Array or Float32Array).

`set_rotation_rel()`, `set_rotation_rel_v()` Set the object's rotation quaternion measured in its parent's space. The first function takes separate coordinates as arguments while the second one takes a four-component vector (Array or Float32Array).

`get_scale()` Get the object's scale in world space.

`get_scale_rel()` Get the object's scale in its parent's space.

`set_scale()` Set the object's scale in world space. Unity corresponds to the original scale of the object. Values less than unity mean scaling down, bigger than unity - scaling up. Note that not all objects can be scaled. Particularly, scaling is not allowed for physics objects.

`set_scale_rel()` Set the object's scale in its parent's space.

`set_rotation_euler()`, `set_rotation_euler_v()` Set the object's rotation using Euler angles. An intrinsic YZX rotation system is used (that means the angles follow in the YZX order and the origin of coordinates rotates and takes up a new position for every angle).

`set_rotation_euler_rel()`, `set_rotation_euler_rel_v()` Set the object's rotation using Euler angles measured in its parent's space.

`move_local()` Move the object relative to its original position (in local space).

`rotate_x_local()`, `rotate_y_local()`, `rotate_z_local()` Rotate the object relative to its original position (in local space).

Get Object API

To perform any operation with an object, you first need to get it (i.e. receive the link to it). There are several API functions for doing this. A link to an object has `Object3D` type.

`get_object_by_name()` Get object by name.

```
// ...
var obj = m_scenes.get_object_by_name("Object");
// ...
```

`get_object_by_dupli_name()` Get the duplicated object by empty name and dupli name.

```
// ...
var obj = m_scenes.get_object_by_dupli_name("Empty", "Object");
// ...
```

`get_object_by_dupli_name_list()` Get the duplicated object by empty name and dupli name list (an array of String type elements).

```
// ...
var obj = m_scenes.get_object_by_dupli_name_list(["Empty1", "Empty2", "Object"]);
// ...
```

`get_object_name_hierarchy()` Returns the object names hierarchy array (from the highest parent to the object itself) for a given object.

```
// ...
var names = m_scenes.get_object_name_hierarchy(obj);
// ...
```

`check_object_by_name()` Check if object with given name is present on scene.

```
// ...
var object_exists = m_scenes.check_object_by_name("Cube");
// ...
```

`check_object_by_dupli_name()` Check if duplicated object is present on scene by empty name and dupli name.

```
// ...
var object_exists = m_scenes.check_object_by_dupli_name("Empty", "Cube");
// ...
```

`check_object_by_dupli_name_list()` Check if duplicated object is present on scene by empty name and dupli name list (an array of String type elements).

```
// ...
var object_exists = m_scenes.check_object_by_dupli_name_list(["Empty1", "Empty2", "Object"]);
// ...
```

`get_object_name()` Get the object's name.

```
// ...
var object_name = m_scenes.get_object_name(obj);
// ...
```

Object Selection

In order to enable selection of a certain object, it is required to enable the Selectable checkbox on the Selection and Outlining panel.

Note: Make sure that the status on the Scene > Object Outlining panel is set to ON or AUTO.

Object selection is possible programmatically via API, for example, in the `scenes.js` module there is the `pick_object` function which selects an object based on canvas 2D coordinates,

```
// ...
var x = event.clientX;
var y = event.clientY;

var obj = m_scenes.pick_object(x, y);
// ...
```

or using the [Logic Editor](#).

If the selectable object has enabled `Enable Outlining` and `Outline on Select` checkboxes on the Object > Selection and Outlining panel, then the `pick_object` function call will activate [outline glow animation](#).

Note: If the selected object is transparent (Blend, Add and Sort transparency types), outline glow will only be visible on the parts that have Alpha value higher than 0.5.

Copying Objects (Instancing)

It is often required to copy (to make instances of) objects during application work.

Copying objects has its limitations:

- only MESH objects can be copied
- the object should be [dynamic](#) (enable `Rendering Properties > Force Dynamic Object`)
- the source object should belong to the active scene

Making a Simple Copy

In case of simple copying the new object will share the mesh with the original object. Thus, if the original object's mesh is changed, the copied object's mesh will be changed too. To make simple copying possible, it's enough to turn on the `Blend4Web > Force Dynamic Object` setting in the source object's properties.

Making a Deep Copy

In case of deep copying, the new object will have unique properties, namely it will have its own mesh. Thus, if the original object's mesh is changed, the copied object's mesh will not be changed. Also, the canvas textures on the copied objects are different textures and not one and the same like it is the case with the simple copying. To make deep copying possible, it is required to enable the [Rendering Properties > Dynamic Geometry](#) checkbox for the source object. |

Copying objects in runtime can be performed with the `copy` method of the `objects.js` module. This method requires three arguments: the id of the source object, a unique name for the new object and the boolean value to specify the copy mode (i.e. simple or deep). By default, simple copying will be performed.

The newly created object should be added to the scene. This can be performed with the `append_object` method of the `scenes.js` module. The new object should be passed to it as an argument.

```
// ...
var new_obj = m_objects.copy(obj, "New_name", true);
m_scenes.append_object(new_obj);
m_transform.set_translation(new_obj, 2, 0, 2);
// ...
```

Removing Objects

To remove objects, use the `remove_object` method of the `scenes.js` module. Pass the object to it as an argument. Dynamic mesh- and empty-type objects can be removed this way.

```
// ...
m_objects.remove_object(new_obj);
// ...
```

Quaternions

Quaternion is a four-component vector used to perform rotating. Quaternions have a number of advantages over other rotation methods such as:

- A quaternion has no ambiguity and doesn't depend on the rotation order as the Euler angles.
- Quaternion's memory usage is more effective (2-4 times less depending on the matrix used).
- Better computing efficiency than for matrices in case of a series of rotations.
- Numeric stability - compensation for multiplication errors arising from float number inaccuracy.

- Convenient interpolation method.

Quaternions have some drawbacks:

- Rotating a vector with a quaternion is more computationally expensive than rotating with a matrix.
- It is difficult to use quaternions for non-rotation transformations (such as perspective or orthogonal projection).

The engine has a number of functions to make it more convenient to work with quaternions:

`quat.multiply` Quaternion multiplication. Note that left-multiplying A quaternion by B quaternion $A*B$ is a rotation by A. I.e. the object already has some rotation B which we supplement with a new rotation by A.

`quat.setAxisAngle` A quaternion is an alternative presentation of rotation by an arbitrary angle relative to the arbitrary axis (vector). Positive direction of rotation is defined as anticlockwise when viewing from the vector's end. For example the `quat.setAxisAngle([1, 0, 0], Math.PI/2, quat)` call forms a quaternion which can be used for rotating the object by 90 degrees (anticlockwise if viewing from the X axis' end) relative to the X axis.

`quat.slerp` Spherical interpolation of quaternions. Used for smoothing the object's rotation and animation.

`util.euler_to_quat`, `util.quat_to_euler`. Conversion from Euler angles and back.

Quaternion Example

We need to rotate the object by 60 degrees in a horizontal plane to the right. We have a model named "Cessna" in Blender.

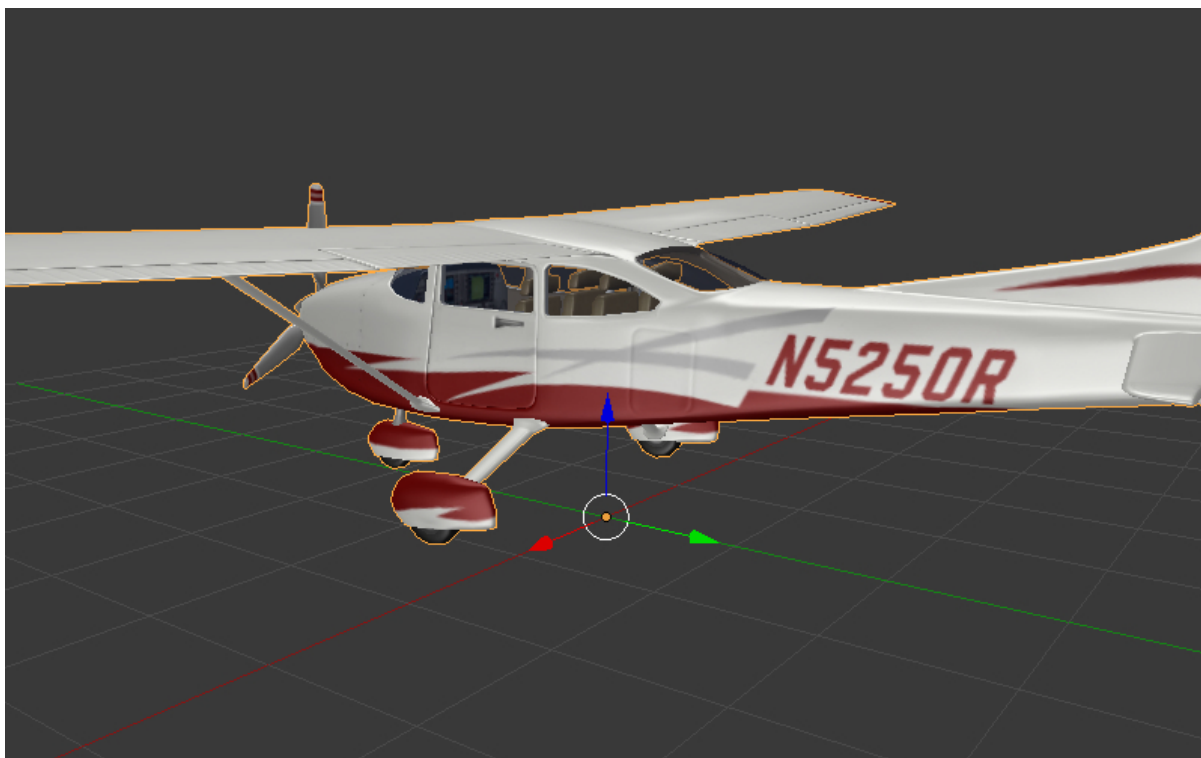

Let's save a reference to the object in the aircraft variable:

```
var aircraft = m_scenes.get_object_by_name("Cessna");
```

Let's rotate it:

- A clockwise rotation corresponds to the rotation to the right (i.e. in the negative direction).
- 60 degrees = $\pi/3$ radians.

As a result we get:

```
// compose quaternion
var quat_60_Z_neg = m_quat.setAxisAngle([0, 0, 1], -Math.PI/3, m_quat.create());

// get old rotation
var quat_old = m_transform.get_rotation(aircraft);

// left multiply: quat60_Z_neg * quat_old
var quat_new = m_quat.multiply(quat_60_Z_neg, quat_old, m_quat.create());

// set new rotation
m_transform.set_rotation_v(aircraft, quat_new);
```

The optimized version which does not create new objects:

```
// cache arrays as global vars
var AXIS_Z = new Float32Array([0, 0, 1])
var quat_tmp = new Float32Array(4);
var quat_tmp2 = new Float32Array(4);
...
// rotate
m_quat.setAxisAngle(AXIS_Z, -Math.PI/3, quat_tmp);
m_transform.get_rotation(aircraft, quat_tmp2);
m_quat.multiply(quat_tmp, quat_tmp2, quat_tmp);
m_transform.set_rotation_v(aircraft, quat_tmp);
```

Moving via TSR Vectors

It is sometimes convenient to move objects using vectors of the following format:

$$[T_x, T_y, T_z, S, R_x, R_y, R_z, R_w]$$

Here T_x, T_y, T_z - the components of the translation vector, S - scale factor, R_x, R_y, R_z, R_w - the components of the quaternion vector. Hence the name of this vector: TSR or TSR-8.

This vector can be operated via `tsr` module, as well as via `set_tsr()/get_tsr()` methods of the transform module.

Line Rendering

Blend4Web engine also features an option to render lines defined by sets of points.

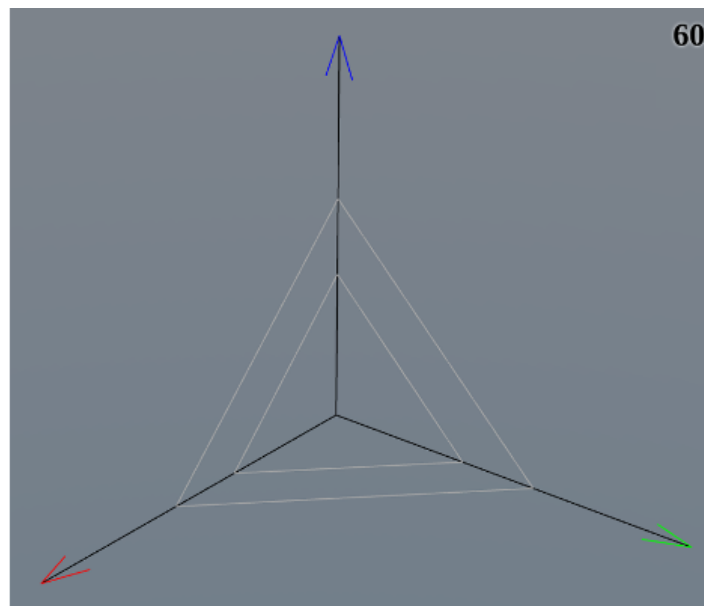

API methods used for line rendering itself are located in the `geometry` module, while the style of a rendered line (i.e. its color and thickness) can be set with the `set_line_params()` method of the `material` module.

To use line rendering, at least one Empty type object with enabled Line Rendering option needs to be present in the scene.

To render a line, you first have to [retrieve a link](#) to an Empty object. The origin point of this object will then be used as a center of coordinates when rendering lines.

The line itself can be rendered by calling the `draw_line()` API method. Its first parameter is a link to an Empty object (see above), while the second one is an array of vertices that will be used for building a line. The method is also has a third, optional, parameter, that defines the rendering mode: whether the method will produce a single line or a set of lines defined by pairs of vertices (in the latter case, the total number of vertices should be even).

If an Empty object is used to render more than one line at a time, only the last one will be visible. To render multiple lines, you will need to use multiple Empty objects.

The following example shows a part of the coordinate axes object in the picture above rendered using lines:

```
var m_scenes    = require("scenes");
var m_material = require("material");
var m_geometry = require("geometry");
var m_rgba     = require("rgba");
...

//setting up Empty object for line rendering
var line_1 = m_scenes.get_object_by_name("MyEmpty_1");

//setting up style parameters for the lines
m_material.set_line_params(line_1, { width: 3
                                     color: m_rgba.from_values(0, 0, 0, 1.0)
                                   });

//coordinates for main axes
var points_1 = new Float32Array([0, 0, 0, 5, 0, 0, 0, 0, 0, 0, 5, 0, 0, 0, 0, 0, 5]);

//drawing main axes
m_geometry.draw_line(line_1, points_1, true);
```

This code listing produces only the main axes of the object, because listing all of its elements will make the code long and repetitive. The other elements of the object are drawn it the same way.

Levels Of Detail

Overview

LODs, or levels of detail, are versions of a single object with various amounts of detail. Levels of detail are used for the purpose of optimization, and the idea here is that if an object is far from the camera, you can render more simple version of it – for example, the

one with less polygons and simpler material. This can reduce the burden on the GPU without decreasing the quality of the render, as most of the details of the original object won't be visible from the distance.

LODs are often used in large-scale scenes with high object count. More compact scenes may not gain a major performance boost from using this feature. Video game locations such as islands, countrysides or town streets are most suitable for using LODs.

LODs can be set up directly in Blender at the Levels of Detail [panel](#).

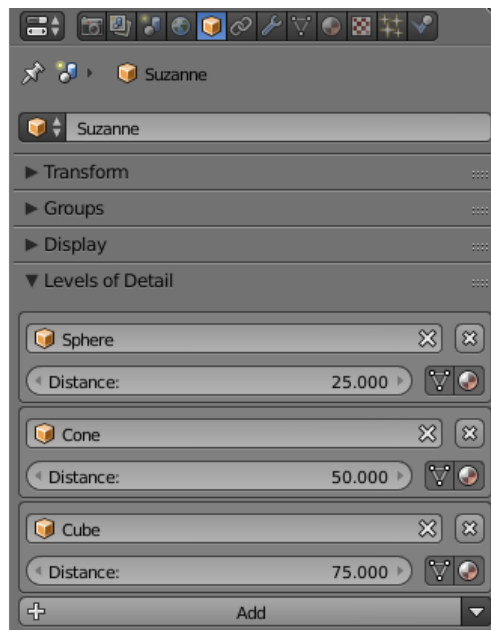

There, you can set levels of detail and distances at which they will be used for an individual object. Each level of detail is a separate object. The main rule is obvious: the lower the level of detail is positioned in the list, the simpler the corresponding object should be.

You can make your objects simpler in different ways: by decreasing its polycount, by making the materials less complex (this is especially true for node materials) or by turning off various effect such as [shadows](#), [animations](#) or [Wind Bending](#).

The number of levels can be set as you see fit, depending on the overall scale of the scene.

Specifics and Differences From BGE

Setting up LODs and using them in the engine has some specifics. Also, BGE mode in Blender has its own LOD system that is mostly identical to the one used in Blend4Web, but still has some differences that are mentioned below.

1. When you are applying a LOD object to some other object, the position of the LOD object will not change. So, if you want the objects to occupy the same place in the runtime, you should manually place them in the same location in Blender. This is different from BGE, where a selected LOD object is automatically moved to the center of the main object.

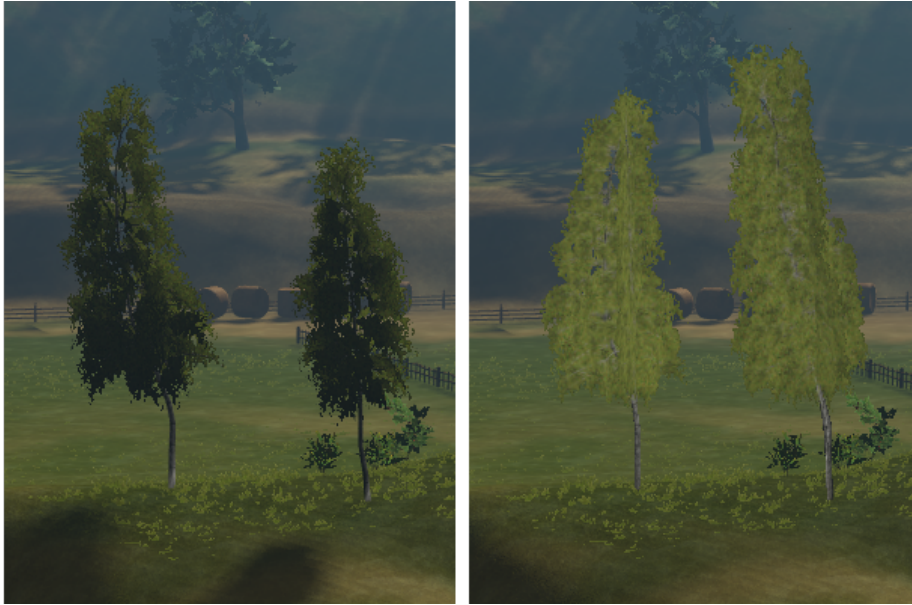

Figure 11.1: Levels of detail for trees: original object at the left, its LOD on the right

2. If you need to set the same LOD object for multiple different objects (for example, same-type trees, building, cars or shrubs), you should make a copy of it for every object (i.e., make as many copies as there are objects that will use this object as a LOD) and set these copies as LODs. Unlike BGE, copies are not generated automatically when you select the same LOD object for multiple base objects. To simplify creating same-type object, we recommend to put the base object and all its LODs to one group and then duplicate this group using Empty objects.
3. If the object is supposed to change its position in the runtime, you should attach its LODs to it in Blender using parent-child link so LOD object would copy its transformations.

Smooth LOD Switching

One of the most notable shortcomings of the LOD system is the abrupt switching between levels of detail which is easy to notice and can be annoying.

The engine supports smooth transition between LODs based on alpha test.

The option used for this is called LOD Smooth Transitions and can be found on the Scene->Object Clustering & LOD [panel](#).

It is intended for enabling smooth LOD transition and setting object types that this transition will be applied to. It should be noted that enabling this option might significantly decrease performance (it depends on the number of LOD objects and their materials).

Note: Smooth LOD transition is not always required. For example, if you instantly transport your camera to some distant object, you probably don't want LOD switching to occur right in front of it. In cases like this, the `lod_leap_smooth_threshold` parameter should be used. It defines the threshold distance (in meters) that the camera can cover



Figure 11.2: Smooth transition between the original object and its LOD.

in one frame. If this value is exceeded, LODs are switched instantaneously. This can be used to disable smooth LOD transition when camera is teleported to a new location or simply moves very fast.

```
var m_cfg = require("config");  
  
m_cfg.set("lod_leap_smooth_threshold", 5); // 5 meters
```

Hysteresis

LODs are switched at certain distances from the object. These level borders are set up on the Levels of Detail panel. If the camera is moving near a border like this, it can cross it often, which results in frequent LOD switching. Under such circumstances, LOD switching becomes very apparent and thus undesirable.

This problem can be negated with the Max LOD Hysteresis Interval parameter located on the Scene->Object Clustering & LOD panel. It sets an interval (in meters) that is used as a gap between two LOD levels.

For example, if Max LOD Hysteresis Interval is set to 4 meters while the distance between detail levels is equal to the 20 meters, one level will be turned on at the distance of 18 meters and the other, at the distance of 22 meters. Using this option eliminates frequent LOD switching, as levels of detail no longer have definite border between them. The setting is adaptive and can adjust to different LOD distances, reducing the set interval, if needed.

Table of Content

- Meshes
 - Static and Dynamic Meshes
 - Settings
 - * Override Bounding Volumes
 - Morphing

Meshes are a subclass of [objects](#). Meshes are different from objects of the other types in a sense that they have geometric structure that is visible in the scene. All objects user can see in a scene are either meshes or converted to meshes on export (like the [CURVE](#), [TEXT](#), [METABALL](#) and [SURFACE](#) type objects).

[Blend4Web](#) addon has several tools for mesh editing, including the [normal editor](#).

This chapter provides an overview of the MESH type object parameters and settings, as well as the API functions to work with them.

Static and Dynamic Meshes

All MESH objects can be divided into static and dynamic.

Static meshes are meshes that can be merged together if they have the same material.

Dynamic meshes are meshes that cannot be combined with each other. Merging of static meshes - so called batching - is performed automatically when the scene is loaded in order to optimize the number of draw calls. The conversion is performed even if there is just one object in the scene. The center of the resulting mesh is located in the origin.

Meshes that have animation, physics or a parent, which is a dynamic object, are considered dynamic.

Settings

Meshes have all settings of the [objects](#) and several additional settings.

Override Bounding Volumes

This section is used to override bounding volumes. Such volumes are used to check object's visibility, to handle collisions and physics interaction. By editing them, you can achieve various effects.



The Override Bounding Volumes section can be found on the Blend4Web panel (beside the normals editor.).

Show Boundings

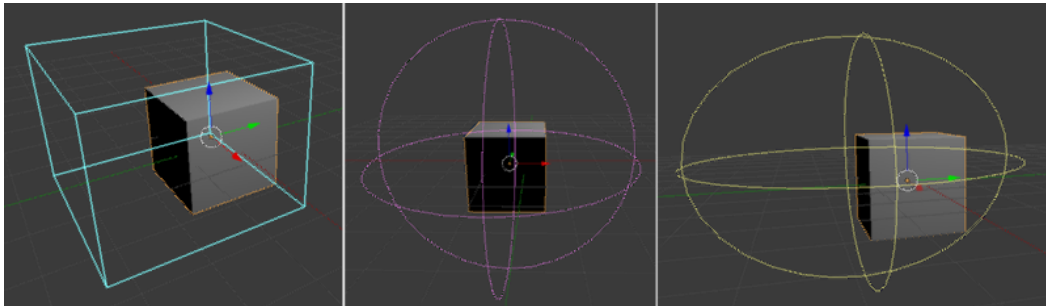

Show the bounding volumes in the Blender viewport. This option works only if the Override Mesh Boundings parameter is enabled. The volume can be rendered as a rectangular cuboid or as a combination of circles or ellipses. More than one method of rendering can be active at the same time (even all three methods can be enabled simultaneously).

Note: The selected rendering method does not affect the bounding volume shape, only the way it is represented in the viewport.

Override Mesh Boundings

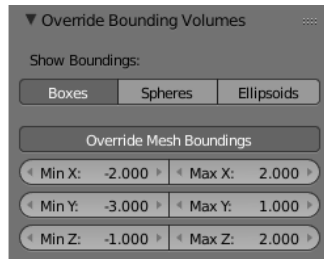

This button enables the override of the basic mesh boundings. The bounding volume always has the shape of a rectangular cuboid with a center in the object's pivot point.

MinX and MaxX The volume's X dimensions. By default, $\text{MinX} = -1$, $\text{MaxX} = 1$

MinY and MaxY The volume's Y dimensions. By default, $\text{MinY} = -1$, $\text{MaxY} = 1$.

MinZ and MaxZ The volume's Z dimensions. By default, $\text{MinZ} = -1$, $\text{MaxZ} = 1$

Morphing

Morph targets can be added using Blender's standard Mesh > Shape keys interface.

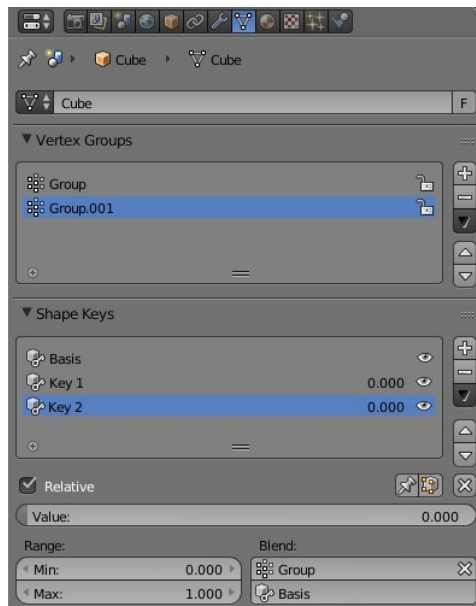

The engine supports all shape key options under the "Relative" type.

To set a shape key value, use the `apply_shape_key` method of the `geometry.js` module.

Note: The object must have Export Shape Keys parameter enabled.

```
// ...  
var obj = m_scenes.get_object_by_name("Object");  
m_geometry.apply_shape_key(obj, "Key 1", 0.5);  
// ...
```

Normal Editor

Table of Contents

- Normal Editor
 - Main Features of the Normal Editor
 - Interface
 - Activate
 - Show Normals
 - Rotate
 - Scale
 - Absolute and Offset Modes
 - Split Normals
 - Average
 - Restore
 - 3D Cursor, Axis and Face
 - Copy/Paste
 - Copy From Mesh

Editing the selected normals is a pretty easy and effective way to customize 3d model shading without complicating its geometry.

In some cases, using the normal editor you may achieve the effect which is similar to the result of using [normal maps](#). At the same time, editing normals is preferred because it is more computationally effective and consumes less video memory.

Normal editor workflow example:



Simple geometry shading is to the left, a tree with edited normals is to the right.

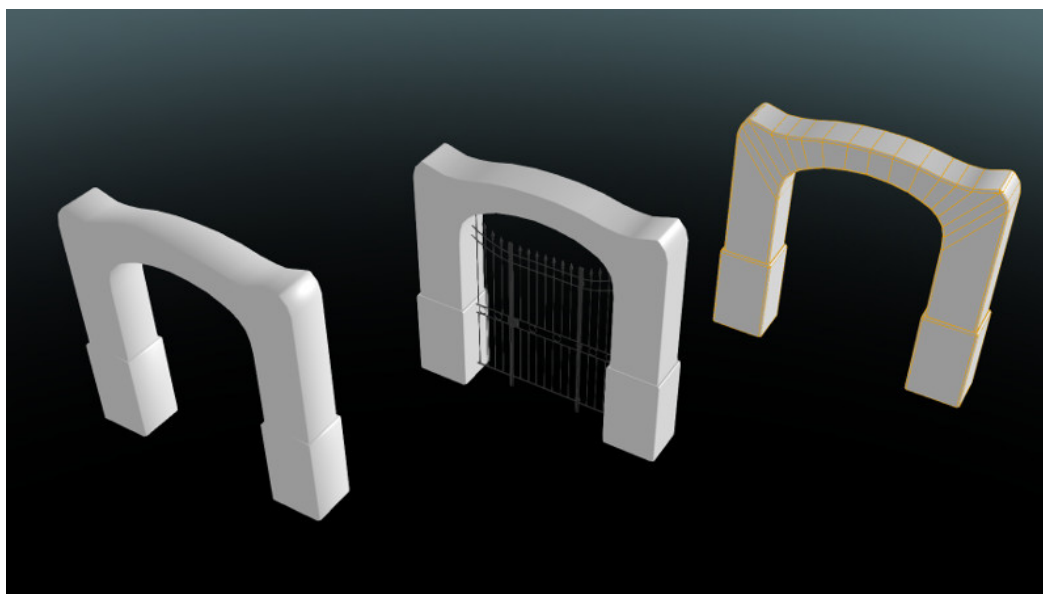

To the left - gates with common shading; at the center - gates with edited normals; to the right - gates geometry with a wireframe.

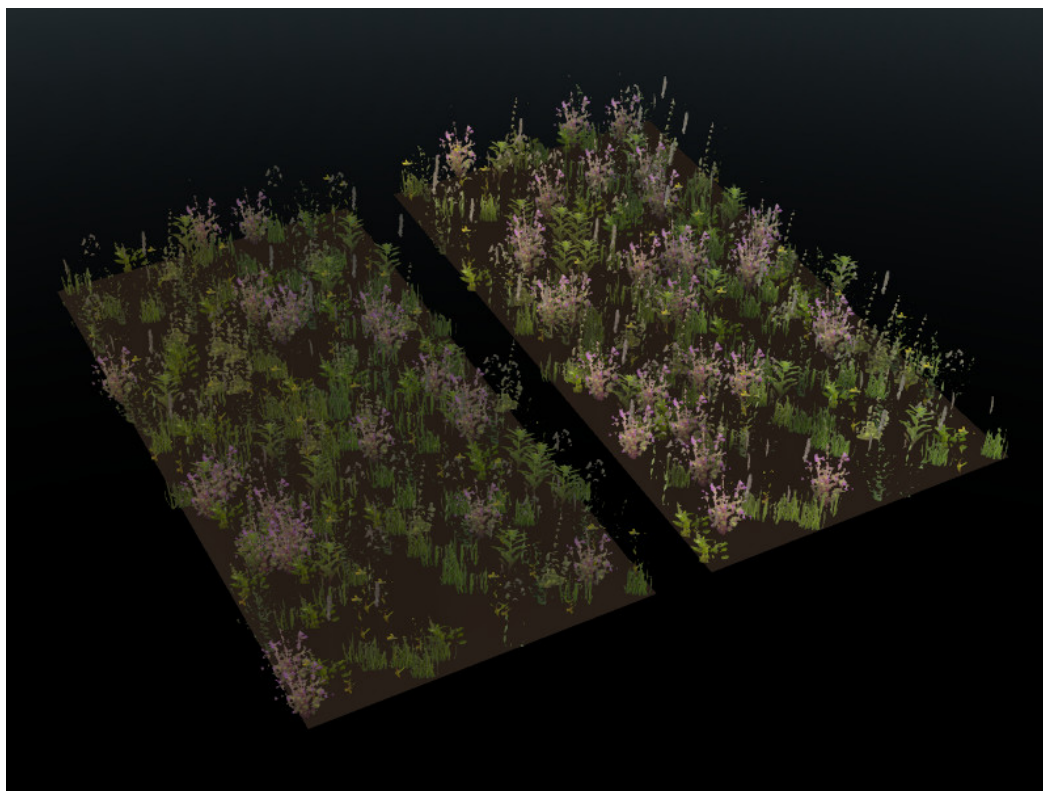

To the left - common grass geometry shading; to the right - grass with edited normals.



To the left - glasses with common shading; to the right - geometry with edited normals shading.

Main Features of the Normal Editor

1. native Blender storage is used as a container for edited vertices normals directions (it appeared in Blender 2.74);
2. normals editing and shading visualization are processed in Edit Mode now;
3. all changes are being saved automatically;
4. selected vertex normal rotation can be performed directly in the Viewport window with Shift+Ctrl+R hotkey, similarly to other rotation operations in Blender;
5. edited normals are being exported automatically.

Interface

The interface of the normal editor is located on the tools panel Blend4Web > Normal Editor. The Shading: Smooth mode should be enabled and Activate button should be pressed or Auto Smooth flag should be enabled in the mesh settings, before starting to work with the editor.

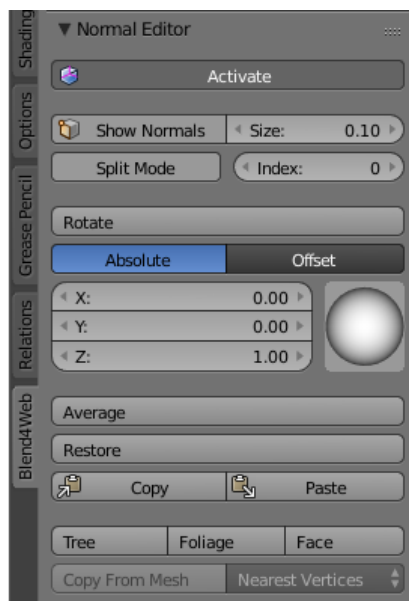

Activate

The Activate button turns on vertex normal editing mode.

You can just press Activate button while in Edit Mode and start editing vertex normals. As it is active, object shading and its export would be processed taking edited vertex normals into account. In other words, after making some changes, this button should be left active if you want to see the changes in the Blender Viewport and in the Blend4Web engine.

Show Normals

This button actually duplicates the original Blender's button. It turns on displaying the normals in the viewport, while the Size field allows you to set their length.

You just need to push the Show Normals button either on the normal editor panel or on the Blender's right panel in the Mesh Display section. You can also set the convenient length of normals by tweaking the Size.

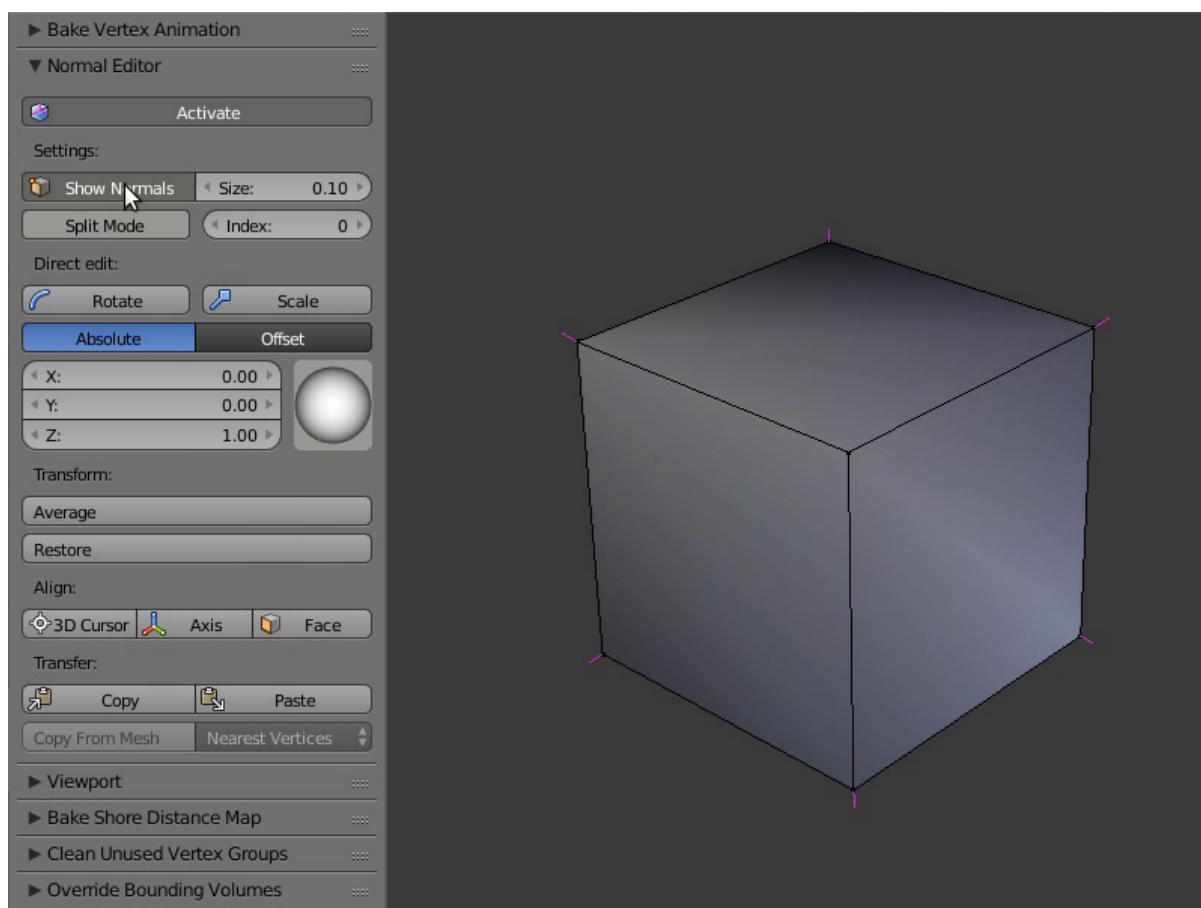

Rotate

Using these instruments you can change direction of the normals. The Rotate function is also available through the Shift+Ctrl+R hotkeys, which allows rotation of vertex normals similarly to Blender.

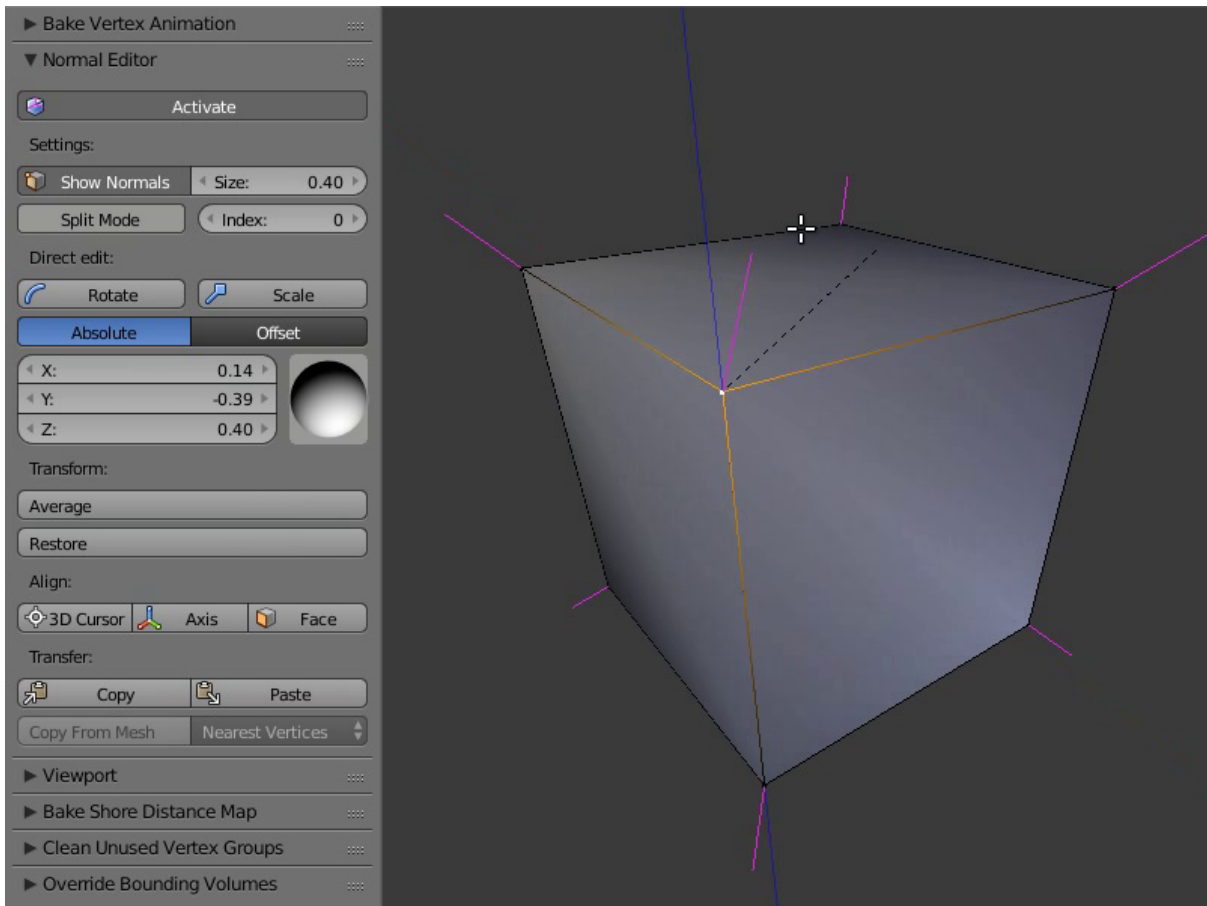

Select one or more vertices that you want to edit and then rotate their normals using the visual sphere or specify the direction as numerical values.

The Rotate button provides a more convenient way to manipulate normals. The rotation is performed in the screen space. Nevertheless, as with any other rotations in Blender, you can isolate the desired axis during rotation (by typing X, Y or Z) and type the angle of rotation using numerical keys.

Scale

This function can be used to change the scale of the normals and is available both from the Tool panel and by pressing the Shift + Ctrl + S hot keys. The length of a normal can be set with numeric keys, while X, Y and Z keys are used to set the coordinate axis along which the normal is scaled.

Note: Keep in mind that the visible length of any normal never changes and is always defined by the Size parameter.

Absolute and Offset Modes

Normal Editor can operate in two different modes: Absolute mode and Offset mode. The currently selected mode can be switched by pressing one of the two buttons placed under the Rotate button that has been described above. By default, Absolute mode is used.

Absolute Mode

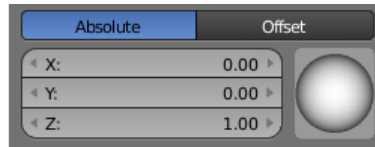

This is the default mode of the Normal Editor. In this mode, the coordinates of a normal vector are absolute and can be set using the X, Y and Z fields or the visual sphere that is situated alongside of them.

Offset Mode

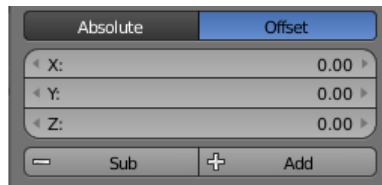

In this mode, a user-defined value is added to the normal vector.

The X, Y and Z fields can be used for setting the corresponding components of the vector, while the Sub and Add buttons define whether the vector should be subtracted from the normal vector or added to it.

Split Normals

The Split Normals mode allows to edit vertex normals separately for each face that form the vertex. Index allows you to navigate between the split normals.

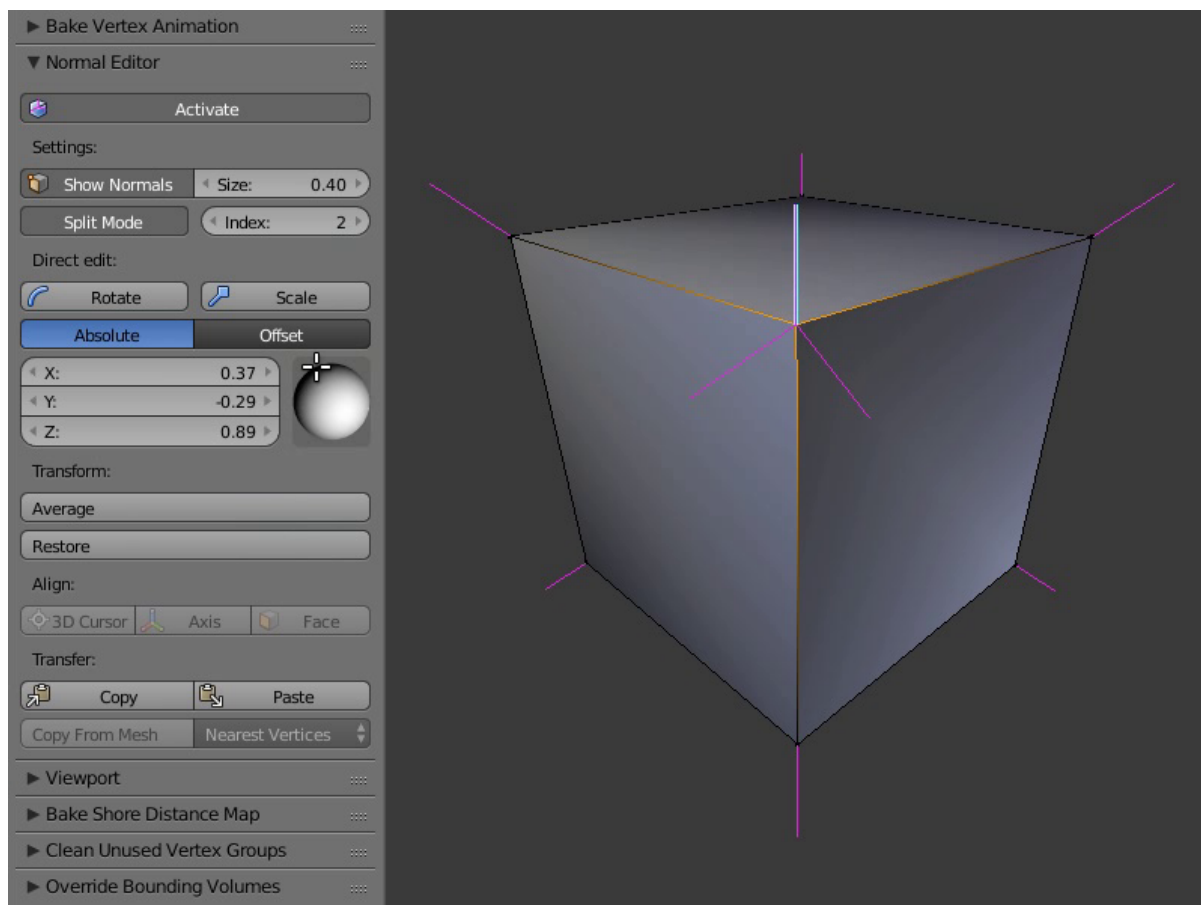

Turn on the Split Normals mode, select the vertex and change the direction of its normals. Firstly, the normal which has the zero index in the queue will be modified. Then, by switching between indexes you can go to the next normal of this vertex and edit it, then to the next and so on.

Average

The Average button averages the direction of the vertex normals which was modified.

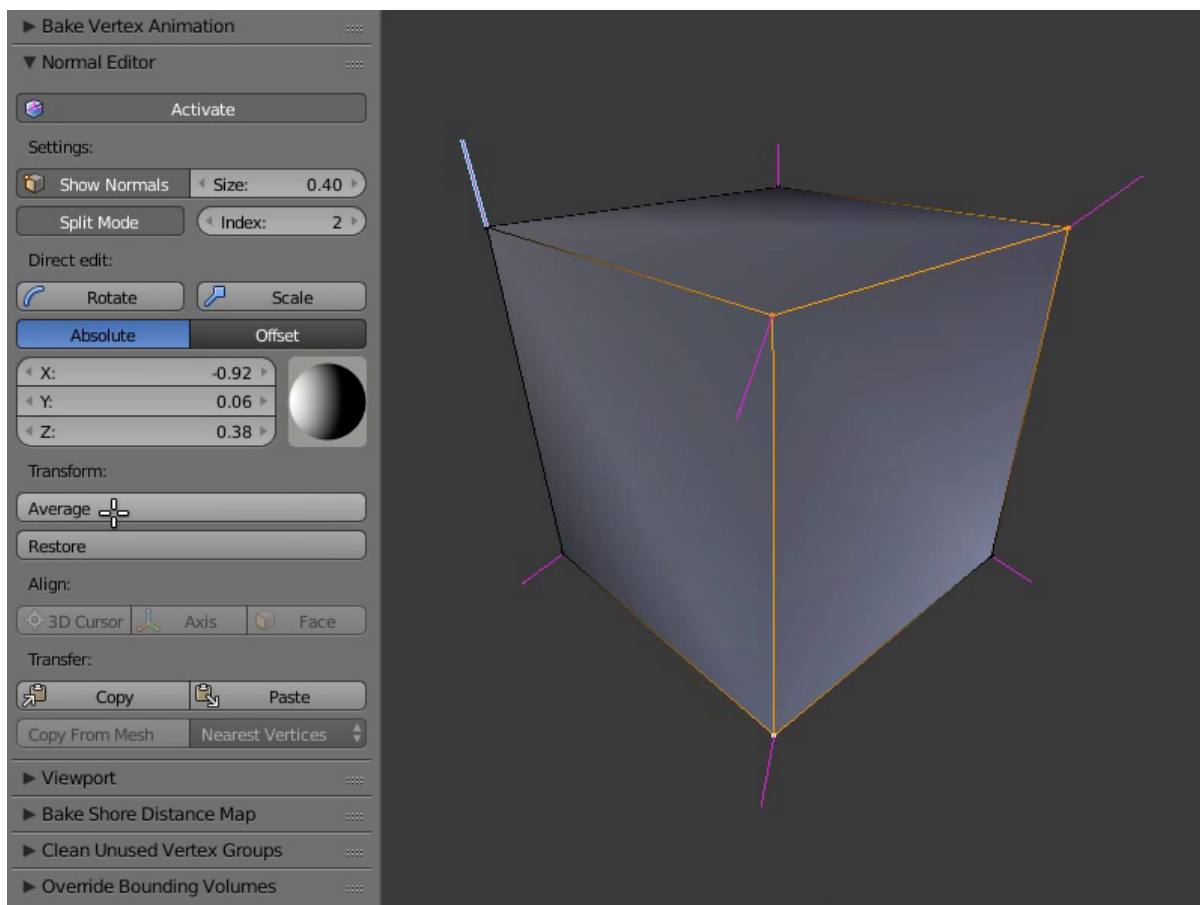

To combine several split vertex normals into one, in order to obtain the average direction of these normals, you just need to select the desired vertex and press the Average Split button.

Restore

The Restore button restores the original direction of normals for the selected vertices.

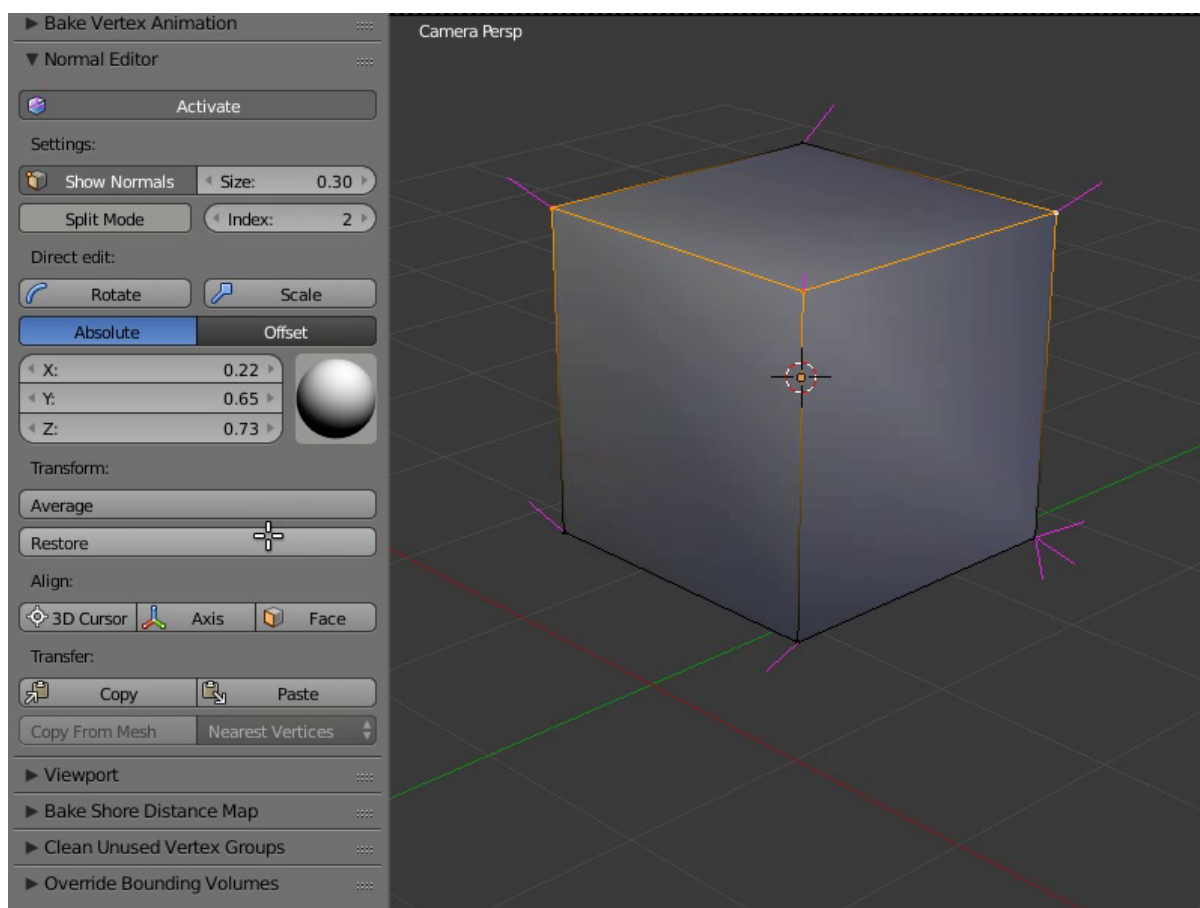

In order to restore the normal's direction to its original (which is calculated on the basis of face normals), you need to select the desired vertices and click the Restore button.

3D Cursor, Axis and Face

The 3D Cursor button directs the normals of the selected vertices away from the 3D cursor or toward it (if the Towards parameter in the Vertex Normal Cursor panel is enabled). The Axis button directs the normals of the vertices along a coordinate axis (the axis can be selected in the same Vertex Normal Cursor panel). The Face button directs the normals of the selected face parallel to the normal of this face.

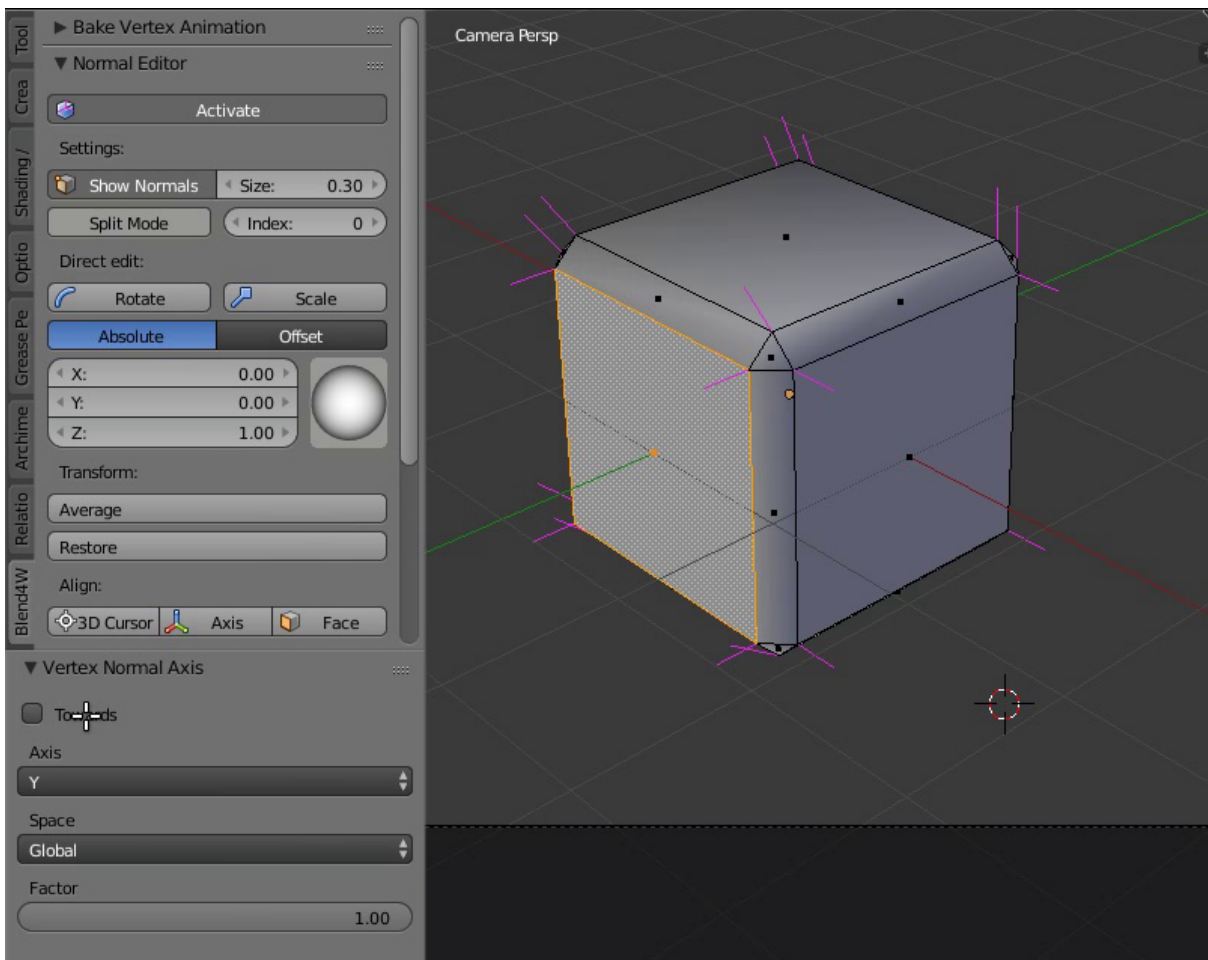
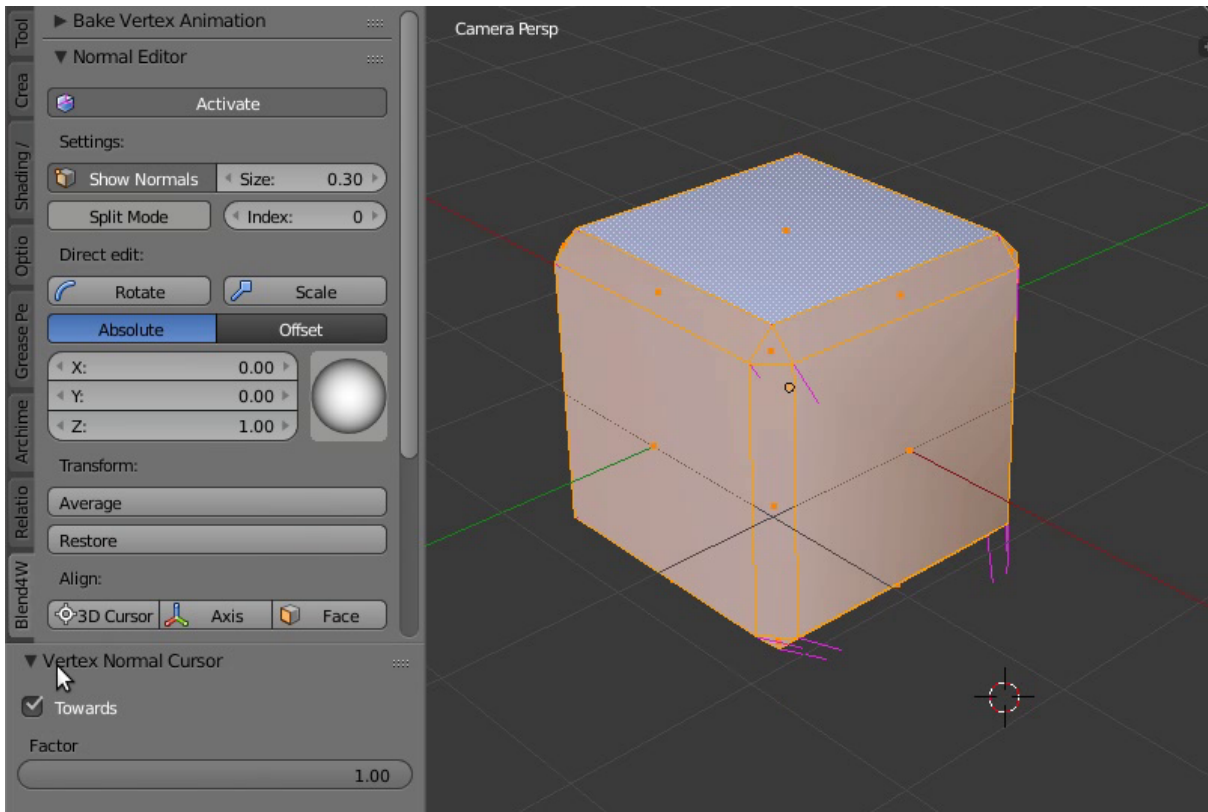

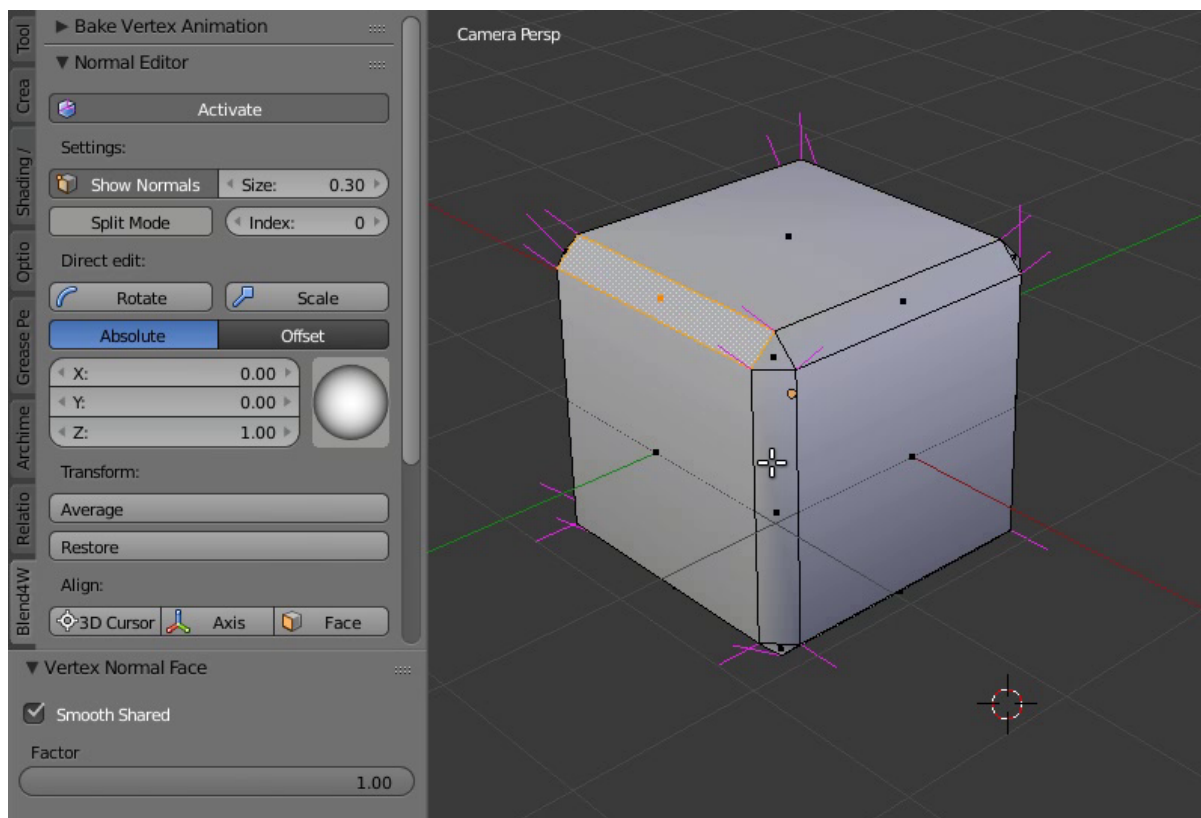

In order to use the 3D Cursor function, select the desired vertices and place the 3D cursor in the desired position. Then click the 3D Cursor button so all the selected vertices will turn their direction away from the cursor, as if they were shot from one point. Then you may check the Towards option in the Vertex Normal Cursor panel, which will make the normals to turn in the direction of the cursor.

The Axis function is very easy to use: just select the vertices and press the button, so the function will direct their normals along the coordinate axis set in the Vertex Normal Cursor panel (Z axis is selected by default) or away from it, if you disable the Towards parameter on the same panel.

In order to direct the normals parallel to the face normal, just select the desired face (or several faces) and click the Face button. The normals of the vertices which form the face will be directed parallel to the face normal. This function works only with one selected face at a time.

The 3D Cursor, Axis and Face operators also possess the Factor parameter which is used to mix the initial position of the normals with the resulting position. The default value of this parameter is 1.0 (the resulting position is used).

Copy/Paste

Copies the normal direction from one vertex to another.

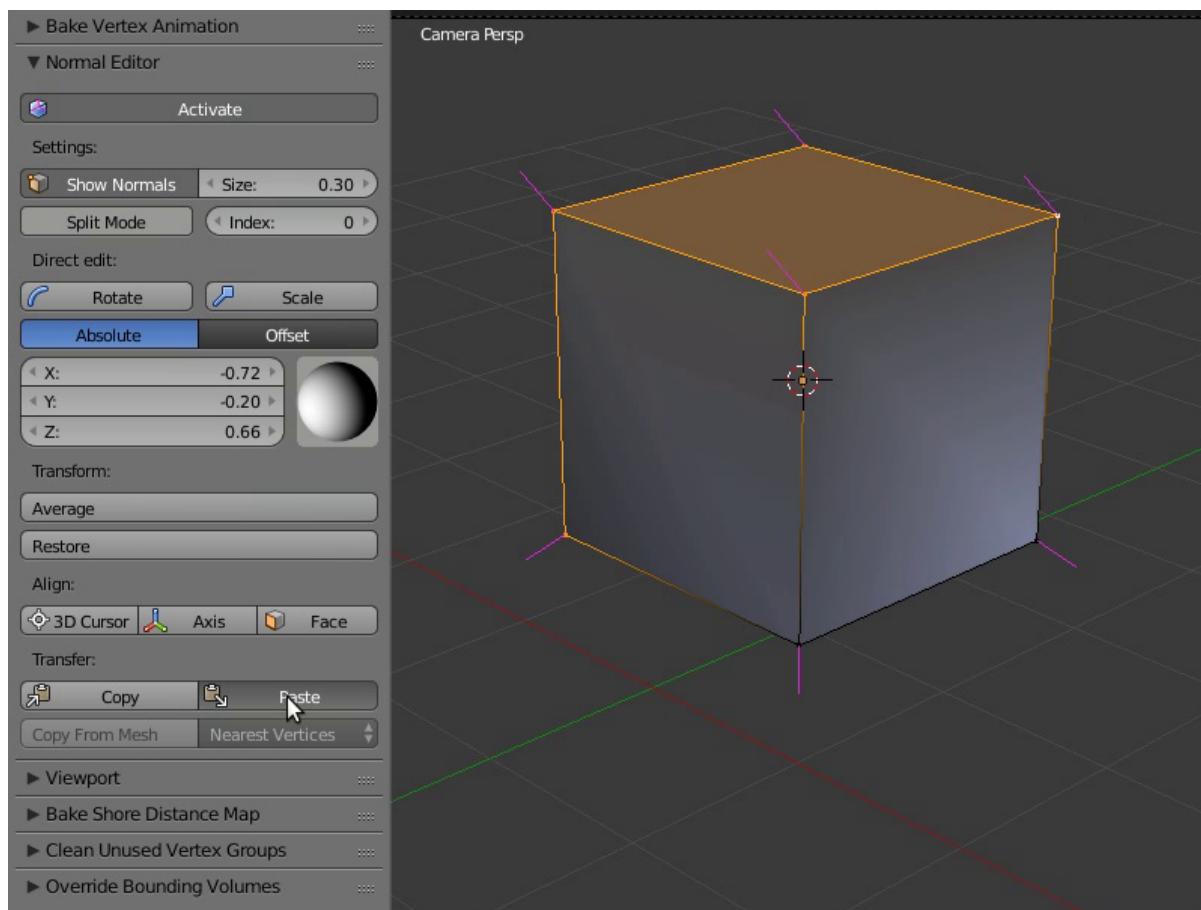

Select the vertex you want to copy from and click the Copy button. Then, select the vertex you want to copy to and click the Paste button. You may copy information from one selected vertex to many different vertices. The buttons are not active in the Split Mode and do not copy data of split vertices.

Copy From Mesh

This function allows you to copy the normals from one object to another. There are two modes: Matched Vertices and Nearest Vertices.

The Matched Vertices mode copies the normals from the vertices of one object to another object's vertices only if they have the same coordinates; the other vertices are ignored. The Nearest Vertices mode copies the normals of the nearest vertices of the source object.

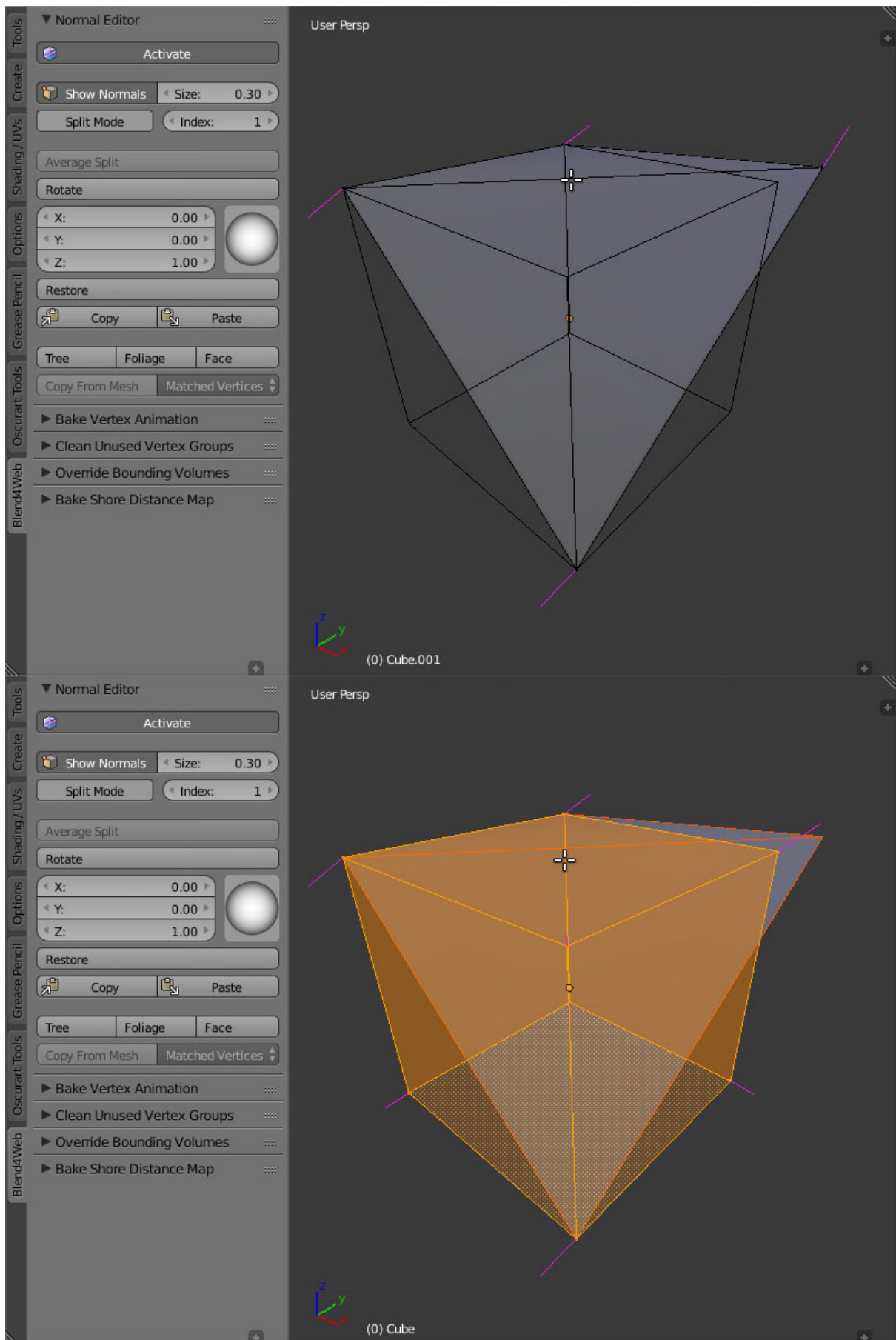

This function works in Blender's object mode. At first, you need to select the object you need to copy from, then the object you need to copy to. It is also necessary to select the target object's vertices to which normals are copied.

Table of Contents

- Camera
 - Move Styles and General Settings
 - Limiting the Camera Movement
 - * Target Type Camera
 - * Eye Type Camera
 - * Hover Type Camera
 - Viewport Alignment
 - Camera Controls API
 - * Control Mode Setup
 - * Translation and Rotation
 - * Limit Setup
 - * Angular Coordinates Count

Move Styles and General Settings

The camera settings are specified in the Properties panel under the Camera (Object Data) tab.

Camera Move Style > Move Style Camera control mode:

- Target By default the camera is rotating around a fixed point (target). The pivot's position can be changed (see [camera panning](#)).
- Eye The Eye mode allows rotation and translation as in first person view.
- Hover In Hover mode, camera moves parallel to the horizontal plane. By using additional limits, a smooth movement path toward the pivot point for the

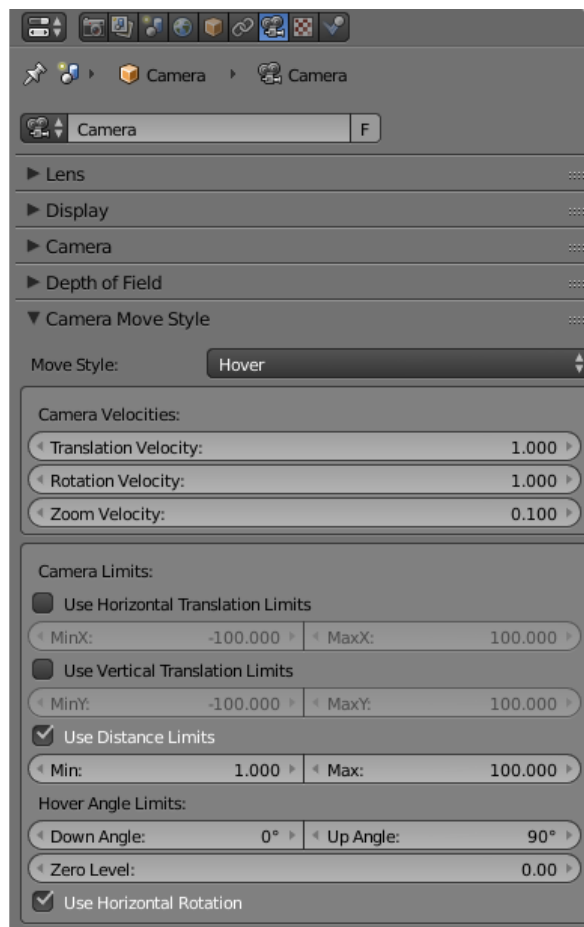

Figure 14.1: Settings available for Camera objects

camera can be created.

- **Static** In the Static mode the camera can be moved via animation or through API calls.

Look At Cursor > Target Location Available for the Target mode. This is the position of the camera pivot point. The Look At Cursor button copies the current 3D cursor position into this value.

Depth of Field Described in the [Depth of Field](#) section.

Velocity settings are available for camera movement.

Camera Move Style > Camera Velocities > Translation Velocity Available for the Target, Eye and Hover type cameras. Sets the velocity of the camera translation. Possible value interval: $[0, \infty)$. Default value is 1.

Camera Move Style > Camera Velocities > Rotation Velocity Available for the Target, Eye and Hover type cameras. Sets the camera rotation speed. Possible value interval: $[0, \infty)$. Default value is 1.

Camera Move Style > Camera Velocities > Zoom Velocity Available for the Target and Hover type cameras. Set the velocity of the camera approaching the pivot point. Possible value interval: $[0, 0.99]$. Default value is 0.1.

Limiting the Camera Movement

There are several settings for the camera which limit/change its movement one way or another. They are grouped as Camera Limits.

Camera limits can be viewed right in the Blender viewport, if the Display Limits in Viewport parameter is enabled.

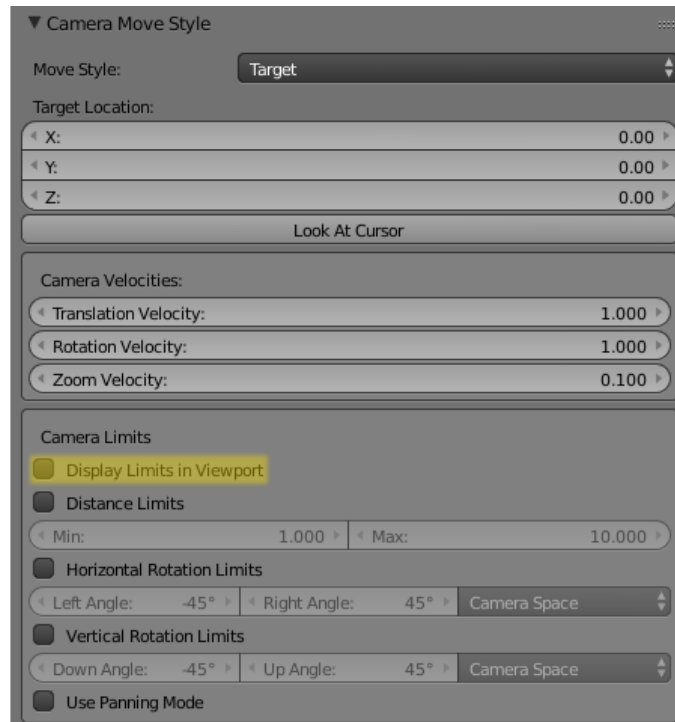
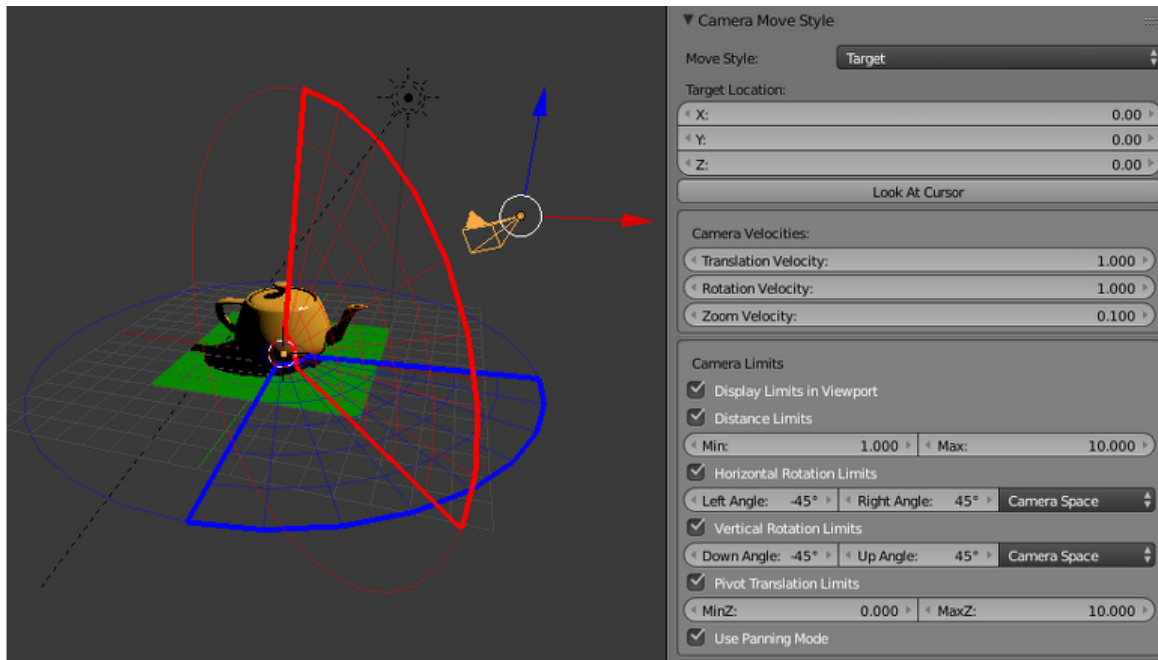
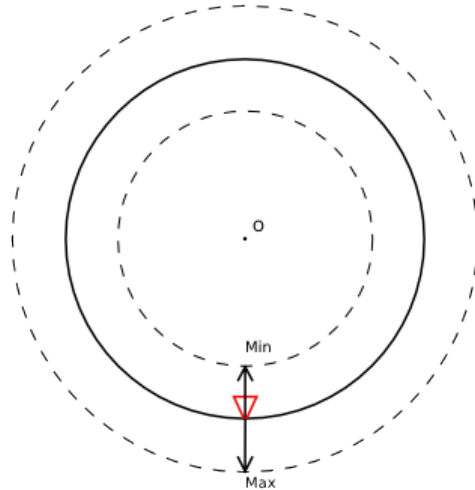

Figure 14.2: Settings for limiting camera movement

Target Type Camera



Camera Move Style > Camera Limits > Distance Limits Set minimum and maximum distances from the camera to the pivot point. Allowable values: $\text{Min} \leq \text{Max}$. Default values: $\text{Min} = 1$, $\text{Max} = 10$. Disabled by default.



Camera Move Style > Camera Limits > Horizontal Rotation Limits Limit the horizontal (around the Z world axis in Blender) camera rotation around the corresponding point. Rotation is performed along the arc of a circle between Left Angle and Right Angle values. The rotation arc corresponds to movement from Left Angle to Right Angle anticlockwise. Default values: Left Angle = -45° , Right Angle = 45° . Disabled by default.

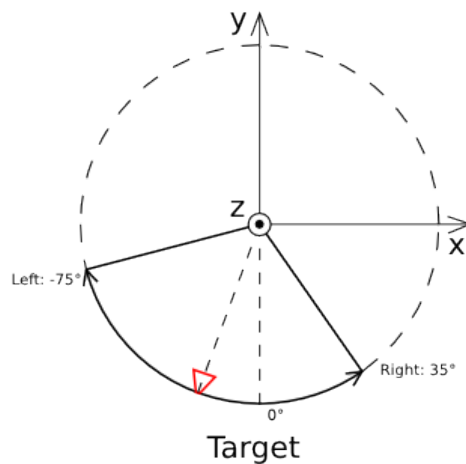

Camera Move Style > Camera Limits > Vertical Rotation Limits Limit the horizontal (around the Z world axis in Blender) camera rotation around the corresponding point. Rotation is performed along the arc of a circle between Left Angle and Right Angle values. The rotation arc corresponds to movement from Left Angle to Right Angle anticlockwise. Default values: Left Angle = -45° , Right Angle = 45° . Disabled by default.

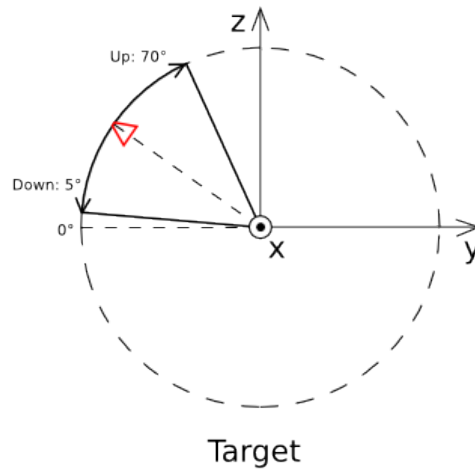

Camera Move Style > Camera Limits > Pivot Translation Limits Limit the translation of the camera's pivot point. Default values: $\text{MinZ} = 0$, $\text{MaxZ} = 10$. Not rendered in the viewport.

Camera Move Style > Camera Limits > Use Panning Mode Allow camera panning.

Eye Type Camera

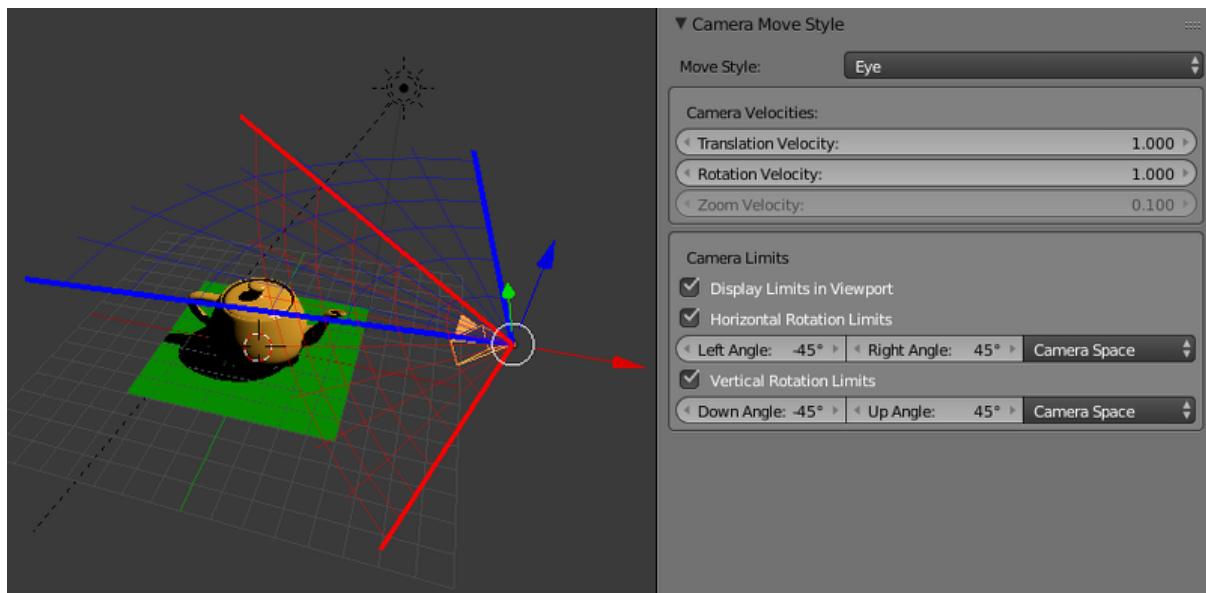

Blend4Web > Horizontal Rotation Limits Limit the horizontal (around the Z world axis in Blender) camera rotation around the corresponding point. Rotation is performed along the arc of a circle between Left Angle and Right Angle values. The rotation arc corresponds to movement from Left Angle to Right Angle anticlockwise. Default values: Left Angle = -45° , Right Angle = 45° . Disabled by default.

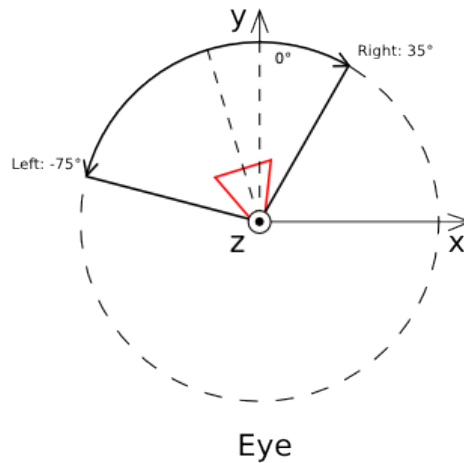

Camera Move Style > Camera Limits > Vertical Rotation Limits Limit the vertical (around the local X axis in Blender) camera rotation around the corresponding point. Rotation is performed along the arc of a circle between Down Angle and Up Angle values. The rotation arc corresponds to movement from Down Angle to Up Angle anticlockwise. Default values: Down Angle = -45° , Up Angle = 45° . Disabled by default.

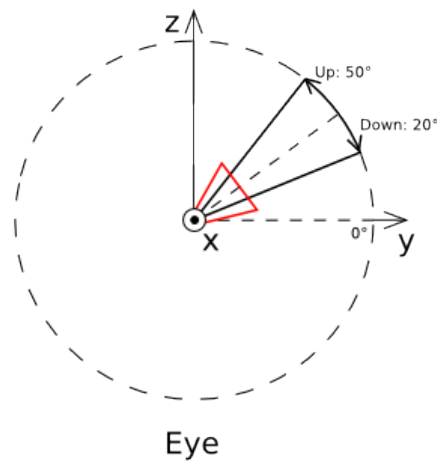

Hover Type Camera

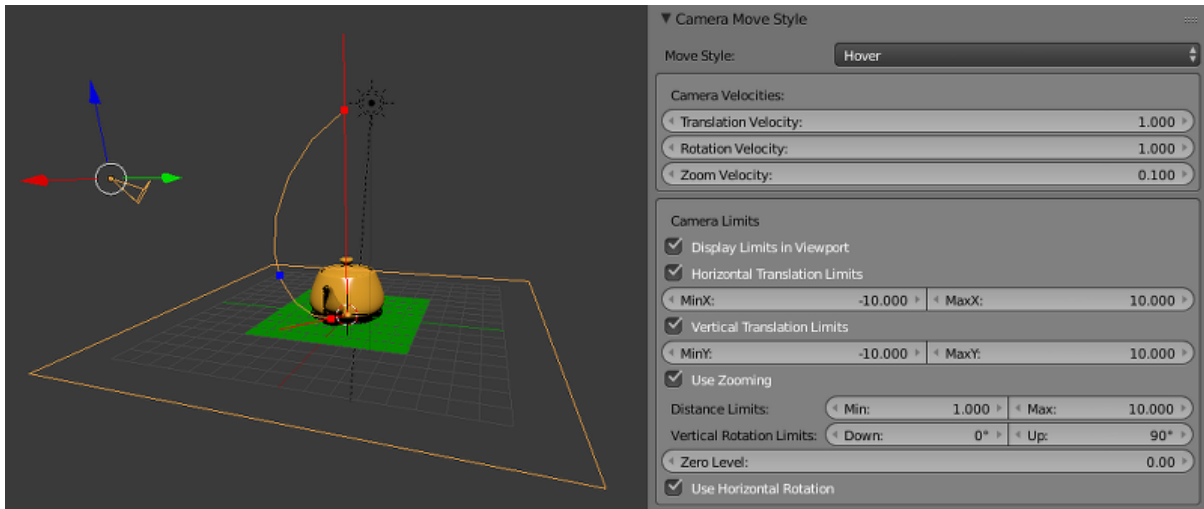

Camera Move Style > Camera Limits > Horizontal Translation Limits Limit movement of the pivot point along the Blender's world X axis. Allowable values: $\text{Min} \leq \text{Max}$. Default values: $\text{MinX} = -10$, $\text{MaxX} = 10$. Disabled by default.

Camera Move Style > Camera Limits > Vertical Translation Limits Limit movement of the pivot point along the Blender's world X axis. Allowable values: $\text{Min} \leq \text{Max}$. Default values: $\text{MinY} = -10$, $\text{MaxY} = 10$. Disabled by default.

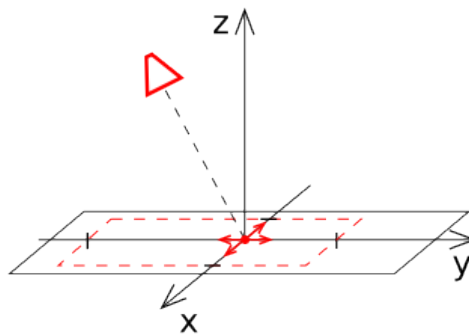

Camera Move Style > Camera Limits > Use Zooming Allows user to zoom the camera in and out from the pivot point. If this parameter is disabled, the camera will always remain at a fixed distance from the pivot point. Disable by default.

Camera Move Style > Camera Limits > Distance Limits Set minimum and maximum distances from the camera to the point of intersection between the camera's view direction and the horizontal reference plane (Blender's world XOY plane by default). Allowable values: $\text{Min} \leq \text{Max}$. Default values: $\text{Min} = 1$, $\text{Max} = 10$. Disabled by default.

Camera Move Style > Camera Limits > Vertical Rotation Limits Limits the camera's angle of elevation (an angle between the camera's sight line and a horizontal plane).

Possible value interval: $0^\circ \leq \text{Down} \leq \text{Up} \leq 90^\circ$. Default values: $\text{Down} = 0^\circ$, $\text{Up} = 90^\circ$.

Camera Move Style > Camera Limits > Zero Level A distance between reference plane and the coordinates origin. Set to zero by default.

If the Blend4Web > Use Zooming setting is turned on, the limits for distance and inclination angle will be applied simultaneously, to define the camera movement path in the vertical plane.

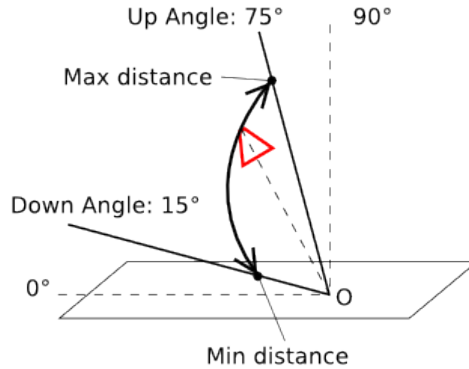

Setting incorrect distance or elevation angle limits will disable this parameter.

Camera Move Style > Camera Limits > Use Horizontal Rotation Allow camera rotation in Blender's XOY plane around to the pivot point. Enabled by default.

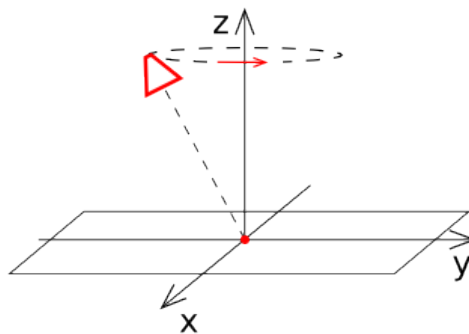

Static Camera

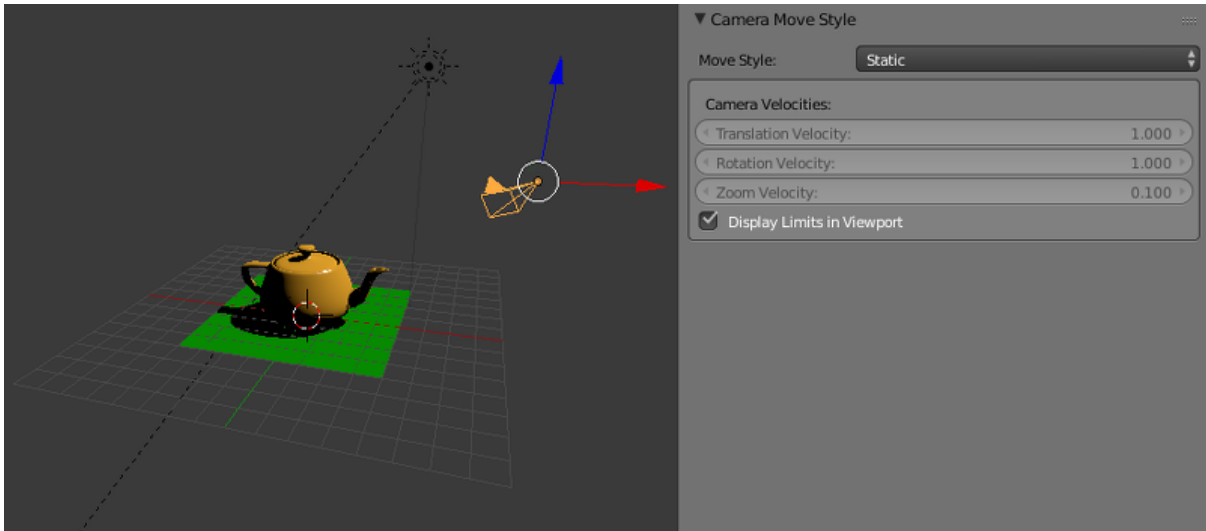

This type of camera does not have limits, as it can't be directly controlled by the user.

Peculiarities of Limiting Settings

- For EYE/TARGET cameras, interchanging Left/Right or Down/Up values results in movement along the opposite arc of a circle.

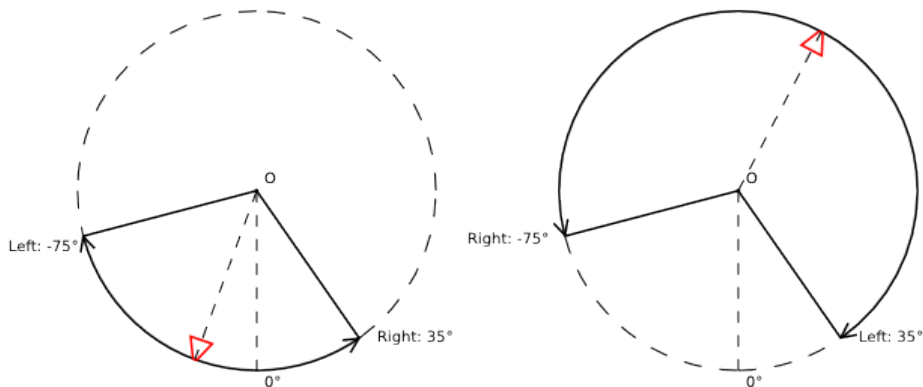

- When limiting the camera's horizontal and vertical rotation, it is possible to choose between the following coordinate spaces:

Camera Space All angles are measured relative to the initial camera position and orientation.

World Space Horizontal angles are measured relative to the Y axis in world space; vertical angles are measured relative to the Blender's XOY plane in world space.

Default value: Camera Space.

Horizontal limits by the example of the TARGET camera:

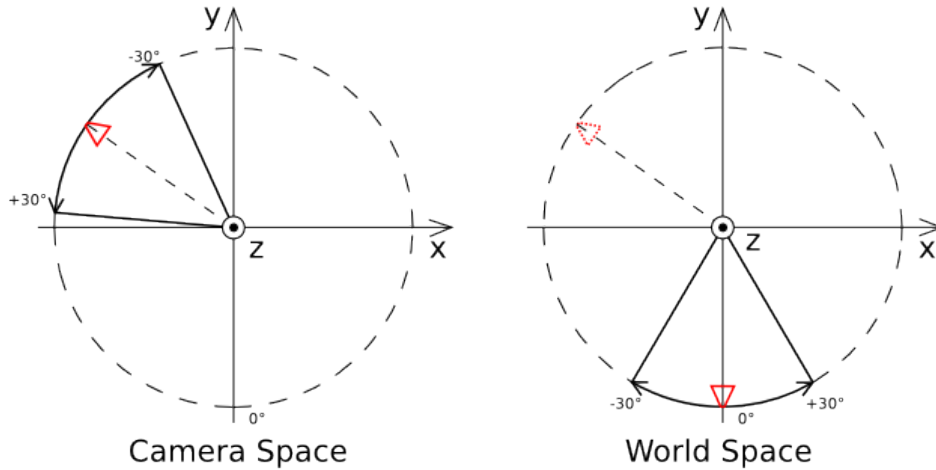

Vertical limits by the example of the TARGET camera:

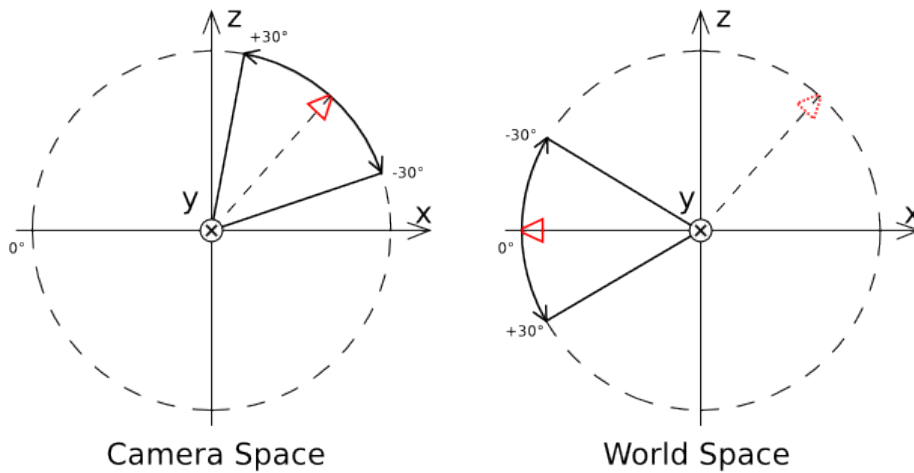

Viewport Alignment

If an object is parented to a camera, the set of parameters known as Viewport Alignment are available under the Relations tab on the Object panel.

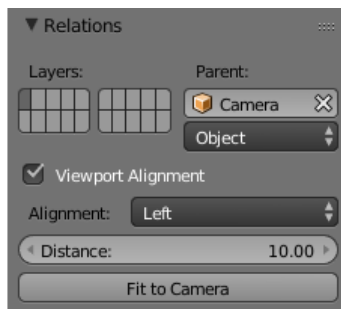

Using these settings, the object can be aligned to the active camera, so that the object will remain in the same place of the screen regardless of the position and rotation of the camera. This is especially useful for creating UI elements.

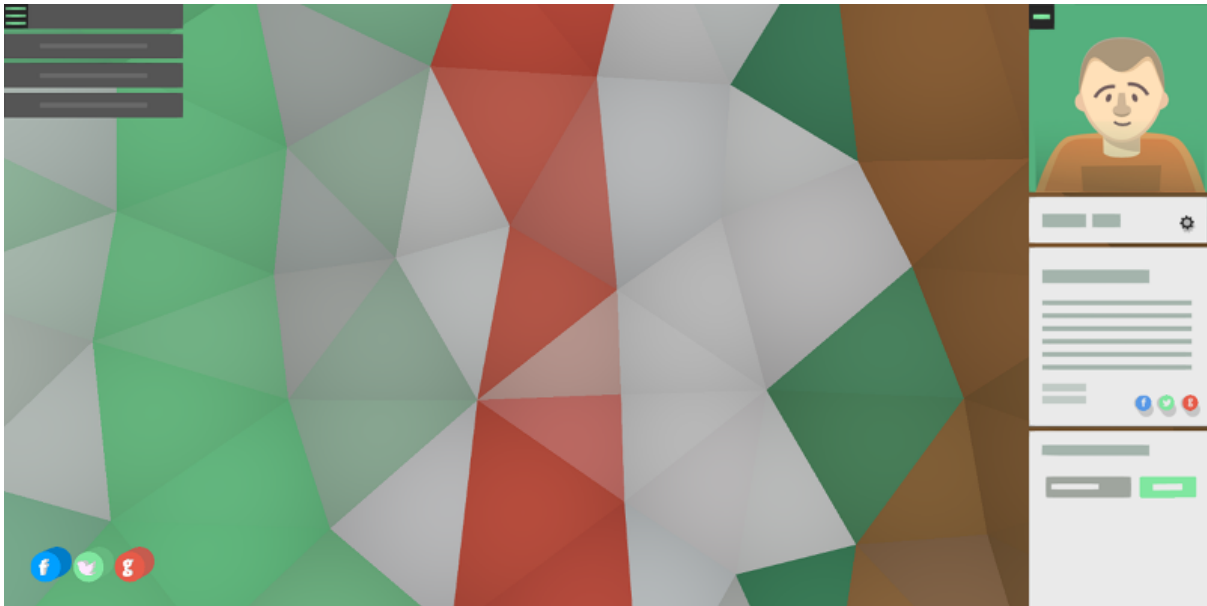

Figure 14.3: All interface elements on this picture are created using the Viewport Alignment option.

Viewport Alignment This parameter enables and disables all the following parameters. It is disabled by default.

Alignment This parameter specifies what side of the screen the object will be aligned with. It can have one of the following values.

- Top-Left - aligns the object in the top left corner of the viewport
- Top - aligns the object in the top of the viewport
- Top-Right - aligns the object in the top right corner of the viewport
- Left - aligns the object in the left side of the viewport
- Center - aligns the object in the center of the viewport
- Right - aligns the object in the right side of the viewport
- Bottom-Left - aligns the object in the bottom left corner of the viewport
- Bottom - aligns the object in the bottom of the viewport
- Bottom-Right - aligns the object in the bottom right corner of the viewport.

Default value is Center.

Distance This specifies the distance between the aligned object and the camera. It is set to 10 by default.

Fit to Camera By pressing this button, you can make the aligned object look the same way in the Blender viewport as it will look in the engine. It can be used to preview alignment results.

Camera Controls API

Detailed API module documentation: [link](#).

A camera's position and its spatial orientation are defined by the control mode. In the EYE, TARGET and HOVER modes, control mode has several limitations: for example, the camera's vertical axis is always aligned along the world's Z-axis and the camera is constantly focused on the pivot point. The STATIC mode camera has no such limitations, which makes it more suitable for cases when you need more complete control, such as procedural animation.

Main functions for camera control are located in the `camera` module. Some of them (intended for a specific control mode) have names which start with an appropriate prefix: `static_`, `eye_`, `target_` and `hover_`. Other functions can be used in any mode.

Control Mode Setup

To change the control mode and to completely define a camera's behavior, the following methods can be used: `static_setup()`, `eye_setup()`, `target_setup()` and `hover_setup()`. These methods receive an object that contains a set of optional parameters, which can be used to set the camera's position, rotation, available limits and so on.

```
var camera = m_scenes.get_active_camera();
var POS = new Float32Array([1,1,1]);
var LOOK_AT = new Float32Array([0,0,0]);
var EYE_HORIZ_LIMITS = { left: Math.PI/4, right: -Math.PI/4 };
var EYE_VERT_LIMITS = { down: -Math.PI/4, up: Math.PI/4 };
var TARGET_DIST_LIMITS = { min: 1, max: 10 };
var HOVER_DIST_LIMITS = { min: 1, max: 10 };
var HOVER_ANGLE_LIMITS = { down: 0, up: -Math.PI/4 };
var HOVER_HORIZ_TRANS_LIMITS = { min: -5, max: 3 };
var HOVER_VERT_TRANS_LIMITS = { min: -1, max: 1 };

...

// setup STATIC camera by defining the new position and the new look-at point
m_cam.static_setup(camera, { pos: POS, look_at: LOOK_AT });

// setup STATIC camera by defining the new look-at point and keeping the existing position
m_cam.static_setup(camera, { look_at: LOOK_AT });

// setup STATIC camera by defining the new position and keeping the existing orientation
m_cam.static_setup(camera, { pos: POS });

// setup EYE camera with horizontal rotation limits
m_cam.eye_setup(camera, { pos: POS, look_at: LOOK_AT,
    horiz_rot_lim: EYE_HORIZ_LIMITS });

// setup EYE camera with vertical rotation limits
```

```

m_cam.eye_setup(camera, { pos: POS, look_at: LOOK_AT,
    vert_rot_lim: EYE_VERT_LIMITS });

// setup TARGET camera with distance limits and panning mode
m_cam.target_setup(camera, { pos: POS, pivot: LOOK_AT,
    dist_lim: TARGET_DIST_LIMITS, use_panning: true });

// setup HOVER camera on a fixed distance (without zooming) relatively to its pivot
m_cam.hover_setup(camera, { pos: POS, pivot: LOOK_AT });

// setup HOVER camera with zooming (distance + angle limits)
m_cam.hover_setup(camera, { pos: POS, pivot: LOOK_AT,
    dist_lim: HOVER_DIST_LIMITS, hover_angle_lim: HOVER_ANGLE_LIMITS });

// setup HOVER camera with translation limits
m_cam.hover_setup(camera, { pos: POS, pivot: LOOK_AT,
    horiz_trans_lim: HOVER_HORIZ_TRANS_LIMITS,
    vert_trans_lim: HOVER_VERT_TRANS_LIMITS });

// setup HOVER camera with horizontal rotation enabled
m_cam.hover_setup(camera, { pos: POS, pivot: LOOK_AT, enable_horiz_rot: true });

```

The main characteristic of the HOVER type camera is the fact that the distance and elevation angle limits define a certain [path](#) of movement toward the pivot point. The camera will always be located on this path, so its final position can be different from the one returned by the `hover_setup()` method (basically, it is projected onto the path). If you need to set the camera's position on some path, you can use the `hover_setup_rel()` method to set the relative limits.

```

var camera = m_scenes.get_active_camera();
var POS = new Float32Array([1,1,1]);
var PIVOT = new Float32Array([0,0,0]);

...

// setup HOVER camera with maintaining the given camera position and
// ability to zoom-in and zoom-out equally
m_cam.hover_setup_rel(camera, { pos: POS, pivot: PIVOT, dist_interval: 2,
    angle_interval: Math.PI/4 });

```

The current camera mode can be checked with the `is_static_camera()`, `is_eye_camera()`, `is_target_camera()`, `is_hover_camera()` or `get_move_style()` methods:

```

var camera = m_scenes.get_active_camera();

...

if (m_cam.is_static_camera(camera))
    console.log("STATIC camera!");

if (m_cam.get_move_style(camera) == m_cam.MS_EYE_CONTROLS)

```

```
console.log("EYE camera!");
```

Note: If you need to change only some aspects of the camera's behavior, you can use the methods described below.

Translation and Rotation

To rotate a STATIC type camera, you need to use the `static_get_rotation()` and `static_set_rotation()` methods. In these methods, rotation is defined by a quaternion.

```
var camera = m_scenes.get_active_camera();

...

// rotation through a quaternion
var _quat_tmp = new Float32Array(4);
var old_quat = m_cam.static_get_rotation(camera, _quat_tmp);
var new_quat = m_quat.rotateX(old_quat, Math.PI/2, old_quat)
m_cam.static_set_rotation(camera, new_quat);
```

For the EYE, TARGET and HOVER type cameras, rotation is performed in spherical coordinates by using the `eye_rotate()`, `target_rotate()`, `hover_rotate()` and `rotate_camera()` methods:

```
var camera = m_scenes.get_active_camera();

...

// rotate by given delta angles
m_cam.eye_rotate(camera, Math.PI/6, Math.PI/2);

// set absolute rotation in world space
m_cam.eye_rotate(camera, Math.PI/6, Math.PI/2, true, true);
```

Current spherical coordinates of the camera can be obtained by using the `get_camera_angles()` method:

```
var camera = m_scenes.get_active_camera();
var _vec2_tmp = new Float32Array(2);

...

// get camera orientation in spherical coordinates
var angles = m_cam.get_camera_angles(camera, _vec2_tmp);
phi = angles[0];
theta = angles[1];
```

Access to the position of the camera can be obtained by using the `get_translation()` and

`set_translation()` methods. For the TARGET and HOVER modes this means simultaneous translation of an entire model, including camera position and pivot point.

```
var camera = m_scenes.get_active_camera();
var _vec3_tmp = new Float32Array(3);

...

// get camera position
var pos = m_cam.get_translation(camera, _vec3_tmp);

// set new position
var new_pos = m_vec3.set(1, 0, 2, pos);
m_cam.set_translation(camera, new_pos);
```

Additional camera translation methods:

- `target_set_trans_pivot()`, `target_set_pivot_translation()`, `hover_set_pivot_translation()` - sets the position and the pivot point of the camera at the same time;
- `target_get_distance()`, `target_set_distance()` - translation based on the distance to the pivot point;
- `static_set_look_at()`, `eye_set_look_at()` - sets the camera's position and point of sight simultaneously;

Note: Because a camera is a scene object, `transform` module methods can also be used. But, as every control mode influences camera movement differently, results may differ from those expected.

Limit Setup

Camera limits are available for the EYE, TARGET and HOVER type cameras. To set a specific limit, you need to use a specific method:

EYE	TARGET	HOVER
<code>eye_get_horizontal_limits()</code>	<code>target_get_distance_limits()</code>	<code>hover_get_distance_limits()</code>
<code>eye_set_horizontal_limits()</code>	<code>target_get_set_distance_limits()</code>	<code>hover_set_distance_limits()</code>
<code>eye_get_vertical_limits()</code>	<code>target_get_set_distance_limits()</code>	<code>hover_get_vertical_limits()</code>
<code>eye_set_vertical_limits()</code>	<code>target_get_set_distance_limits()</code>	<code>hover_set_vertical_limits()</code>
	<code>target_get_get_horizontal_limits()</code>	<code>hover_get_horiz_trans_limits()</code>
	<code>target_get_set_horizontal_limits()</code>	<code>hover_set_horiz_trans_limits()</code>
	<code>target_get_get_vertical_limits()</code>	<code>hover_get_vert_trans_limits()</code>
	<code>target_get_set_vertical_limits()</code>	<code>hover_set_vert_trans_limits()</code>
	<code>target_get_pivot_limits</code>	
	<code>target_set_pivot_limits</code>	

```

var camera = m_scenes.get_active_camera();
var _limits_tmp = {};
var EYE_HORIZ_LIMITS = { left: Math.PI/4, right: -Math.PI/4 };

...

// get limits
m_cam.eye_get_horizontal_limits(camera, _limits_tmp);

// set limits
m_cam.eye_set_horizontal_limits(camera, EYE_HORIZ_LIMITS);

```

Limit presence can be checked by using the `has_distance_limits()`, `has_horizontal_rot_limits()`, `has_vertical_rot_limits()`, `has_horizontal_trans_limits()` and `has_vertical_trans_limits()` methods.

Note: In HOVER mode, the camera always has distance and elevation angle limits. In case these limits were not set, they are automatically calculated to lock the camera in the current position relative to the pivot point.

Note: Enabled camera limits can influence its position and spatial orientation set by the API functions.

Angular Coordinates Count

When working with the camera's APIs (rotation, setting limits), all angles are defined as follows:

For the TARGET/HOVER camera:

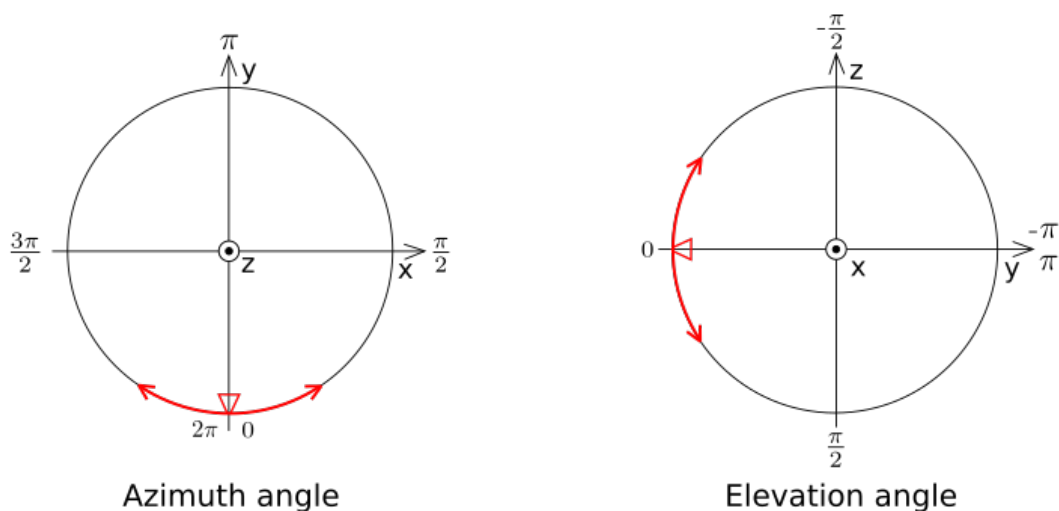

For the EYE camera:

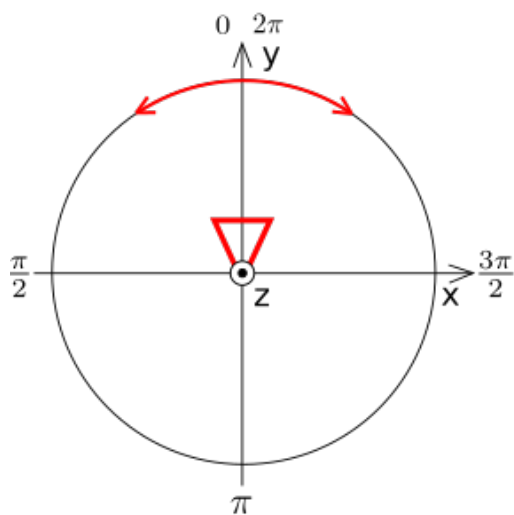

Azimuth angle

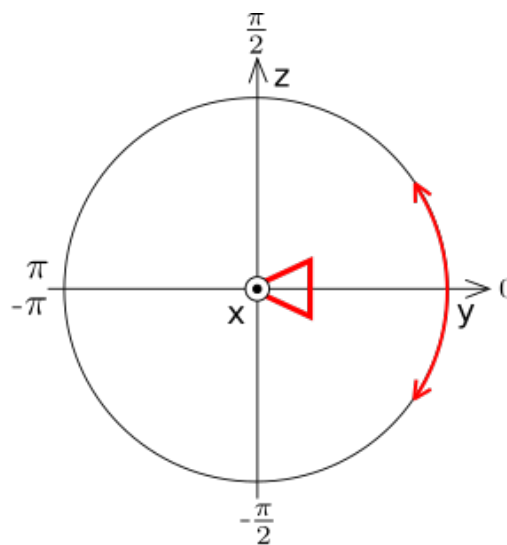

Elevation angle

Table of Content

- Materials
 - Lighting Parameters
 - Transparency
 - * Types
 - * Additional Settings
 - Reflection
 - * Static Reflection
 - * Dynamic Reflection
 - * Fresnel effect for reflection
 - Rendering Properties
 - Viewport Properties
 - Engine Specific Parameters
 - Halo Materials
 - * Activation
 - * Additional Settings
 - Material API
 - * Methods for Stack Materials
 - * Methods for Node Materials
 - * Replacing Textures
 - Inherit Material
 - * Activation

Materials describe the object surface's response to light and also contain information about its transparency, reflectivity, physical parameters and so on.

Meshes can have one or more materials. In case of multiple materials they can be assigned to different polygons in the Edit Mode. To do this select the needed polygons, select the needed material from the list and click the Assign button.

The following material types are supported: Surface, Halo.

Lighting Parameters

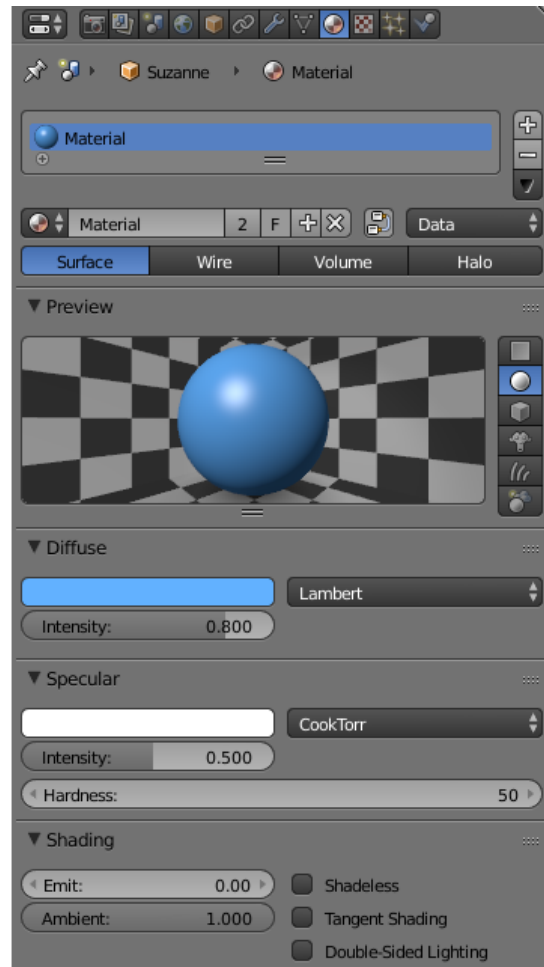

Diffuse > Color Diffuse light color. The default value is (0.8, 0.8, 0.8). It may interact with the diffuse map color.

Diffuse > Intensity Diffuse light intensity. The default value is 0.8.

Diffuse > Shader Diffuse shading algorithm. The default value is Lambert.

Specular > Color Specular light color. The default value is (1.0, 1.0, 1.0). It may interact with the specular map color.

Specular > Intensity Specular light intensity. The default value is 0.5.

Specular > Hardness Exponent in the specular shading calculation formula. The default value is 50. Note that the formula used in the engine differs slightly from the Blender's one.

Specular > Shader Specular shading algorithm. The default value is CookTorr.

Shading > Emit Emission intensity. The default value is 0.0.

Shading > Ambient Ambient influence factor on material. The default value is 1.0.

Shading > Shadeless When enabled, a material doesn't react to light. Disabled by default.

Shading > Tangent Shading When this parameter is enabled, the engine will use the material's tangent vector (instead of normal vector) for calculating the object's color. This can be used for creating anisotropic shading effects.



Figure 15.1: On the left: standard shading model; on the right: tangent shading model.

Shading > Double-Sided Lighting Enables the double-sided lighting mode. This option is useful for non-transparent objects with a single-layered mesh.

Transparency

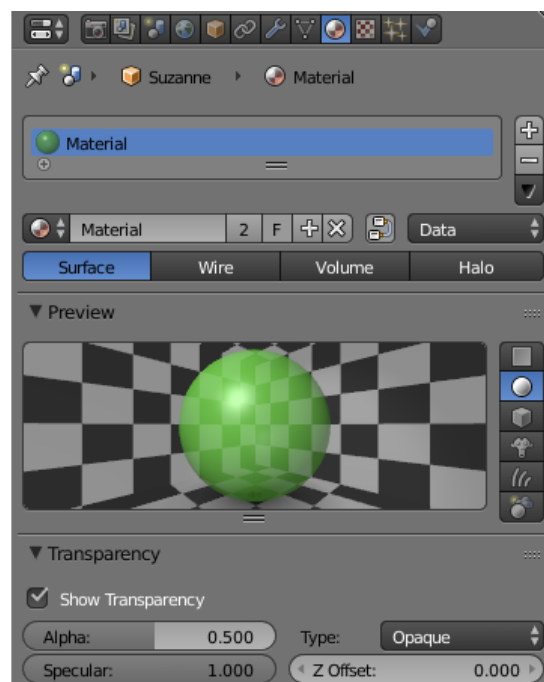

Types

Transparency implementation type can be selected in the Transparency menu on the Properties > Material panel.

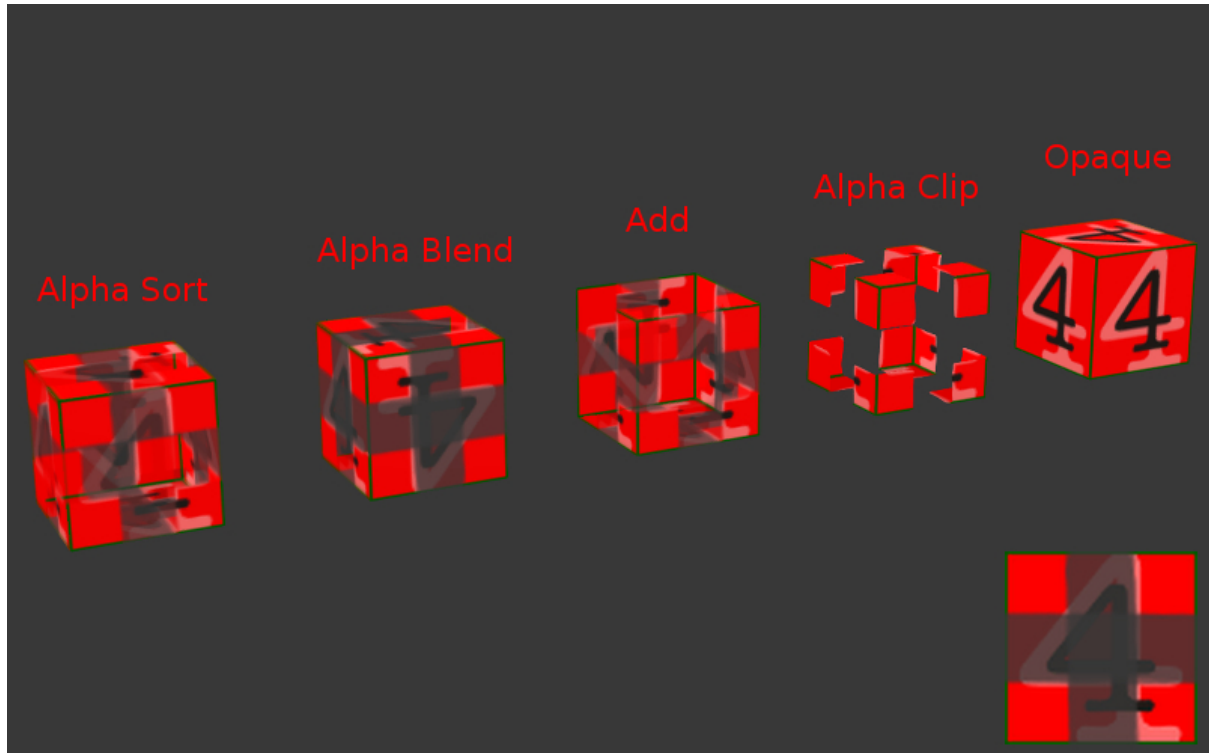

Figure 15.2: The engine supports all of the transparency types available in Blender.

Available transparency types are (sorted in the ascending order by performance):

Alpha Sort Transparent with a gradient. The engine sorts the triangles by camera distance in order to render overlapping transparent surfaces correctly. This operation is computationally expensive. It is recommended to use this feature for closed transparent geometry (bottle, car glass etc).

Alpha Anti-Aliasing Transparent with a gradient. This feature is implemented with the help of the Alpha to coverage technique. It's available only if MSAA is enabled (only on WebGL2-capable devices). The sorting of triangles is not performed. It is recommended to use this feature with a mask texture to visualize smaller details (tree leaves, grass).

Alpha Blend Transparent with a gradient. The sorting of triangles is not performed. It is recommended to use this feature for unclosed transparent geometry (water surface, decals).

Add Transparent with a gradient. The sorting of triangles is not performed. The engine disables writing to the depth buffer which causes transparent surfaces to be rendered in arbitrary order. It is recommended to use this feature for effects (particle systems, glowing beams).

Alpha Clip Transparent without a gradient. The engine discards pixels if their alpha is less than 0.5. The sorting of triangles is not performed. It is recommended to use this feature with a mask texture to visualize smaller details (tree leaves, grass).

Opaque Non-transparent. Alpha is ignored. This is the default value.

Additional Settings

Transparency > Show Transparency Enabling the transparency checkbox is required for viewing transparent objects in Blender. The engine ignores this option - the Alpha Blend option is used instead.

Transparency > Alpha Material transparency level. The engine ignores this parameter (in contrast to Blender) if there is a diffuse texture - the alpha channel values of a texture are used instead.

Transparency > Z Offset This option explicitly specifies relative positioning order of objects with different materials with the purpose of depth sorting. The option can take both negative and positive values. The more distant the object is the lesser parameter value should be to provide correct rendering. The default value is 0.0.

Reflection

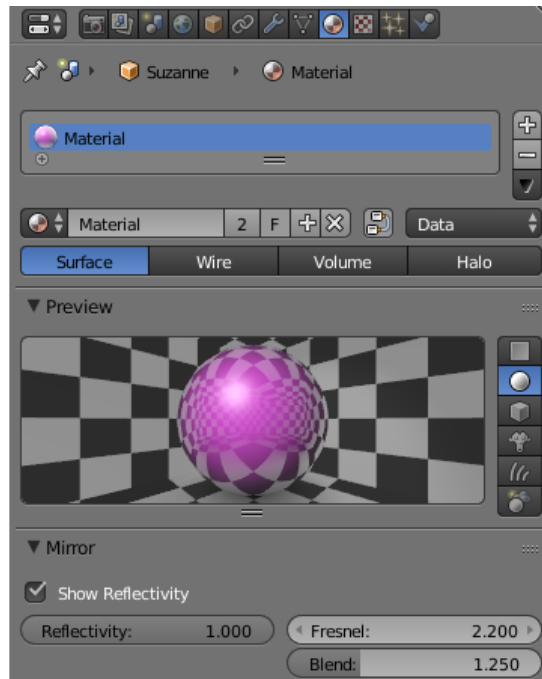

Figure 15.3: Reflection settings in the Material tab

Static Reflection

A surface reflects the same image no matter how the environment changes. For activation simply use the [mirror map](#).

See also:

[Fresnel effect for reflection](#)

Dynamic Reflection

A surface reflects the selected objects in their current position. The engine supports planar and spherical reflections.

Note: If you are using [node materials](#), dynamic reflection will only work if a Material or Extended Material node is present in the node tree.

Activation

1. Check Reflections setting on the Render > Reflections and Refractions panel.
2. For reflective objects enable the Reflective option on the Object > Reflections panel.
 - For planar reflections, set the Object > Reflections > Type property to Plane. After that, add an empty object to be used as a reflection plane by executing for example Add > Empty > Single Arrow. Rename it for convenience and specify its name in the Reflection plane field of the reflective object.
 - For cube-mapped reflections, set the Object > Reflections > Type property to Cube.
3. For the needed materials of the reflective objects, set the Material > Mirror > Reflectivity value.
 - Mirror > Reflectivity > Show Reflectivity is required for displaying reflections on objects in Blender. The engine ignores this option.
4. For the reflexible objects, enable the Reflexible checkbox on the Object > Reflections panel.

Note: It is also recommended to enable the World > Environment Lighting checkbox.

Limitations

Normal maps and shadows are ignored in the reflected image for optimization purposes.

See also:

Fresnel effect for reflection

Fresnel effect for reflection

The Fresnel effect manifests itself as the dependency of the intensity of passing and reflected light on the incidence angle. If the angle of incidence is close to zero (i.e. light falls almost at right angle to the surface) the passing light portion is large and the reflected light portion is small. On the contrary if the angle of incidence is close to 90 degrees (i.e. light falls almost parallel to the surface) almost all light is reflected.

The engine uses the approximate Schlick's formula:

$$R = R_0 + (1 - R_0)(1 - \cos \theta)^N, \text{ where}$$

R - reflection coefficient,

R_0 - reflection coefficient in case of viewing at a right angle to the surface (i.e. when $\theta = 0$),

θ - angle of incidence (which is equal to the angle of reflection under which light enters the camera), it is calculated by the engine in real-time,

N - exponent.

Settings

Fresnel effect can be set up both for static and dynamic reflection.

Material > Mirror > Fresnel Fresnel power for reflection. This is the N exponent in the Schlick's formula. In Blender it is limited to values from 0 to 5. If this parameter is equal to zero the Fresnel effect is not observed and the full reflection at all angles occurs. If this parameter is greater than zero, the material is less reflective when viewing surfaces at angles which are close to the right angle. The bigger this parameter is the bigger is the angle deviation from the right angle for which the Fresnel effect is observed.

Material > Mirror > Blend Fresnel factor for reflection. It is reduced to R_0 in the Schlick's formula by the following expression: $R_0 = 1 - \text{Blend} / 5$. In Blender it is limited to values from 0 to 5. This parameter defines the Fresnel effect intensity: the bigger the Blend factor is, the more is the Fresnel effect influence. If it is equal to zero the Fresnel effect is not observed.

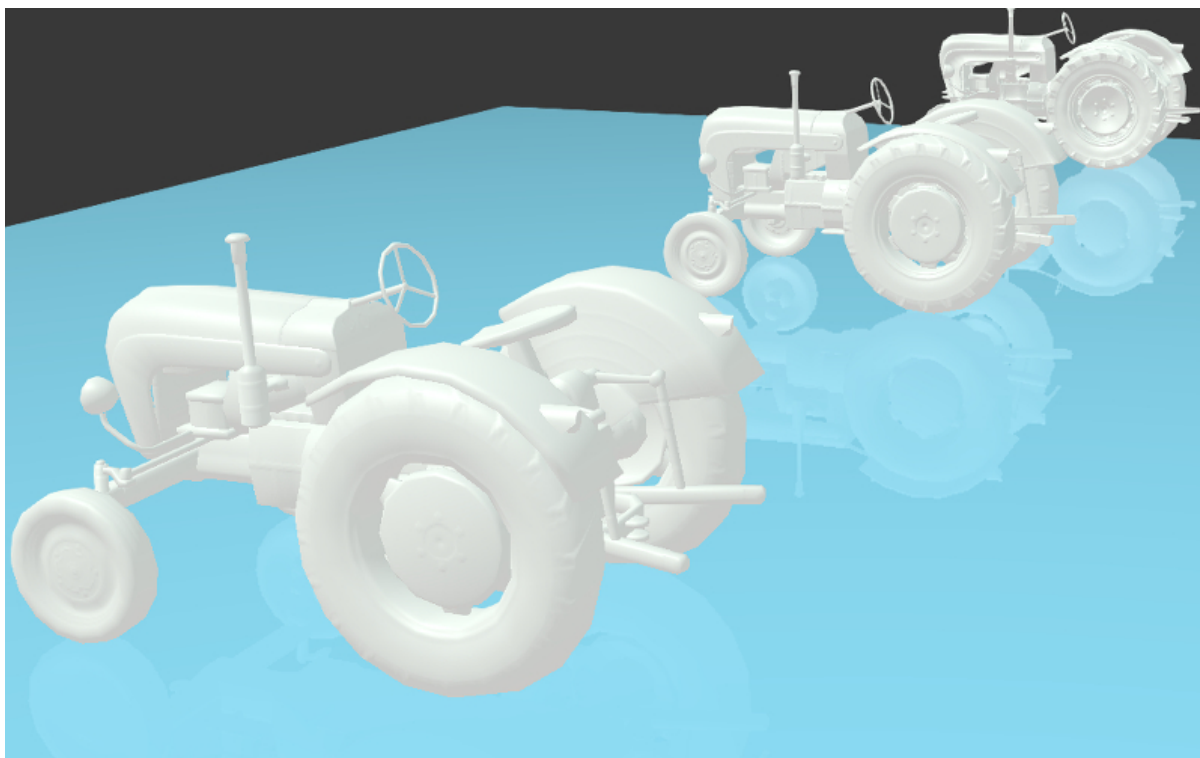

Rendering Properties

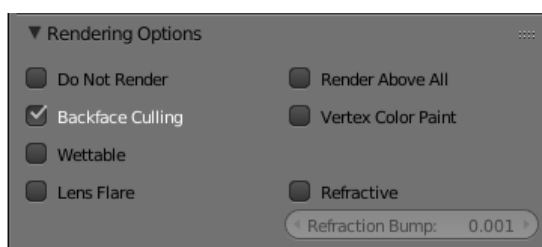

Material > Rendering Options > Do not Render Disable rendering of this object.

Material > Rendering Options > Backface Culling When enabled, polygons' back faces are not rendered by the engine. Enabled by default.

Material > Rendering Options > Wettable Water wetting effect is activated for the material.

See also:

[Water](#)

Material > Rendering Options > Lens Flare Enabling this parameter activates Lens Flare effect for the material.

Material > Rendering Options > Render Above All Material is rendered on top of all scene objects. Transparency type with a gradient is required (Add, Alpha Blend“ or Alpha Sort).

Material > Rendering Options > Vertex Color Paint Mesh vertex color is used instead of the material diffuse color when the checkbox is enabled.

Material > Rendering Options > Refractive Make object refractive. Perturbation factor can be set with the option Refraction Bump on the Refraction Settings panel. The default value is 0.001.

Note: In order to use this effect, select ON or AUTO on the Render > Reflections and Refractions > Refractions panel. The object must have Alpha Blend transparency type.

See also:

[Transparency](#)

Viewport Properties

The Viewport section can be found on the Blend4Web panel.

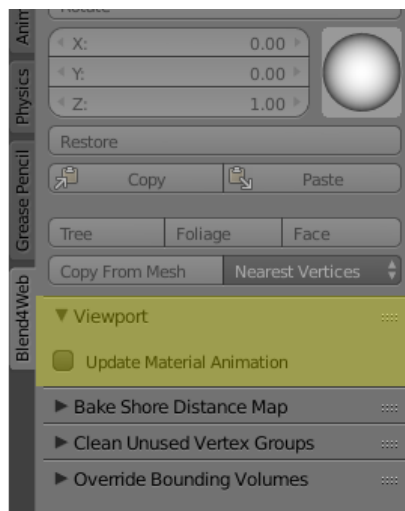

Update Material Animation

Update animated shader in Blender Viewport.

Engine Specific Parameters

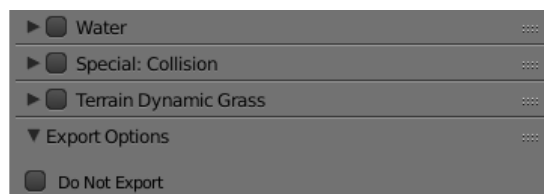

Material > Water Special material for [water rendering](#).

Material > Terrain Dynamic Grass Material is used for [grass rendering](#).

Material > Collision A special material for collision geometry.

See also:

[Physics](#)

Material > Export Options > Do Not Export Material is not to be exported.

Halo Materials

Halo materials are used in particle systems and in static meshes. Using the halo in static meshes is described below.

Activation

Select the Halo type under the Materials tab. It's also recommended to select the transparency type with a gradient (Add, Alpha Blend or Alpha Sort).

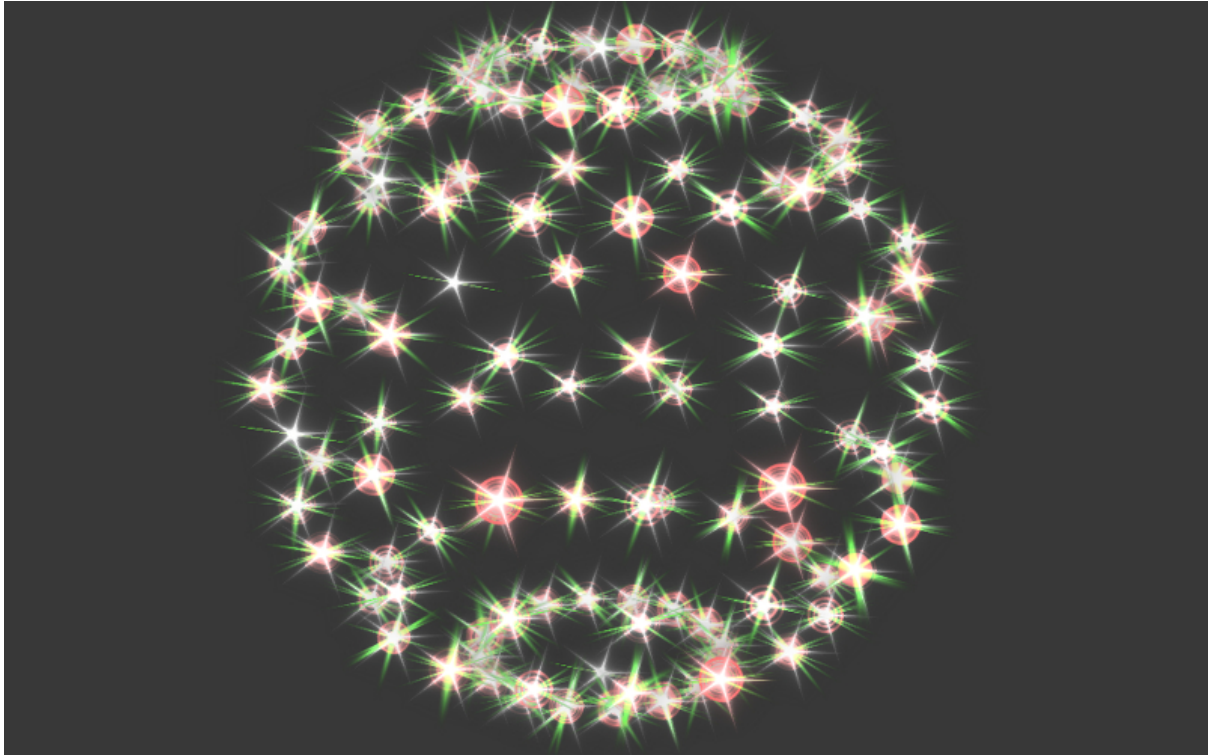

Additional Settings

Halo > Alpha Material transparency factor. The default value is 1.0 (non-transparent).

Halo > Color Material color. The default value is (0.8, 0.8, 0.8) (almost white).

Halo > Size Particle size. The default value is 0.5.

Halo > Hardness Exponent for computing the gradient. Affects visible dimensions of particles. The default value is 50.

Halo > Rings Use rings. Relative quantity and color can be set up.

Halo > Lines Use lines. Relative quantity and color can be set up.

Halo > Star Tips Use stars. The quantity of edges can be set up.

Halo > Special: Stars Enables the starry sky rendering mode. The mesh is fixed relative to the camera. For the Sun lamp it is also required to enable the Lamp > Dynamic Intensity checkbox. Applications should set up the hours of darkness via API.

Halo > Blending Height Height range for the fading of stars.

Halo > Minimum Height Minimum height in the object's local space at which stars are visible.

Material API

All API methods used for setting and changing scene materials, both stack and node, are located in the Material API module. Every method that this module has to offer is thoroughly described in this [page](#) of the API reference.

Note: API methods can only work with materials that are attached to dynamic objects.

Methods for Stack Materials

The `material` API module includes methods to control virtually every aspect of a stack material.

Here are several examples of how the material API module can be used to perform various operations with the material of an object:

Getting object's diffuse color:

```
var m_scenes = require("scenes");
var m_material = require("material");

...

var cube = m_scenes.get_object_by_name("Cube");

var diffuse_color = m_material.get_diffuse_color(cube, "MyMaterial");
var diffuse_color_factor = m_material.get_diffuse_color_factor(cube, "MyMaterial");
var diffuse_intensity = m_material.get_diffuse_intensity(cube, "MyMaterial");
```

Getting object's specular color:

```
var m_scenes = require("scenes");
var m_material = require("material");

...

var cube = m_scenes.get_object_by_name("Cube");

var specular_color = m_material.get_specular_color(cube, "MyMaterial");
var specular_color_factor = m_material.get_specular_color_factor(cube, "MyMaterial");
var specular_hardness = m_material.get_specular_hardness(cube, "MyMaterial");
var specular_intensity = m_material.get_specular_intensity(cube, "MyMaterial");
```

Getting other parameters:

```
var m_scenes = require("scenes");
var m_material = require("material");

...
```

```

var cube = m_scenes.get_object_by_name("Cube");

var emit_factor = m_material.get_emit_factor(cube, "MyMaterial");
var alpha_factor = m_material.get_alpha_factor(cube, "MyMaterial");
var ambient_factor = m_material.get_ambient_factor(cube, "MyMaterial");

var extended_parameters = m_material.get_material_extended_params(cube, "MyMaterial");

```

Setting stack material parameters:

```

var m_scenes = require("scenes");
var m_material = require("material");
var m_rgba = require("rgba");

...

var cube = m_scenes.get_object_by_name("Cube");

m_material.set_diffuse_color(cube, "MyMaterial", m_rgba.from_values(1.0, 0.0, 0.0, 1.0));
m_material.set_diffuse_color_factor(cube, "MyMaterial", 0.05);
m_material.set_material_extended_params(cube, "MyMaterial", {fresnel: 0,
                                                                fresnel_factor: 1.25,
                                                                parallax_scale: 0,
                                                                parallax_steps: "5.0",
                                                                reflect_factor: 0});

```

Methods for Node Materials

At the moment, API methods can only affect RGB and Value nodes. Any other type is not supported.

To change the value of a particular material node, you need:

- to get the object that uses this particular material,
- the name of the material,
- the name of the node itself
- and the name of the node group that contains the node (if there is one).

The name of a node can be viewed and changed in the upper part of the side panel at the right of the Node Editor window.

Note: Nodes in the main window of the Node Editor do not show the name of the node, only its type.

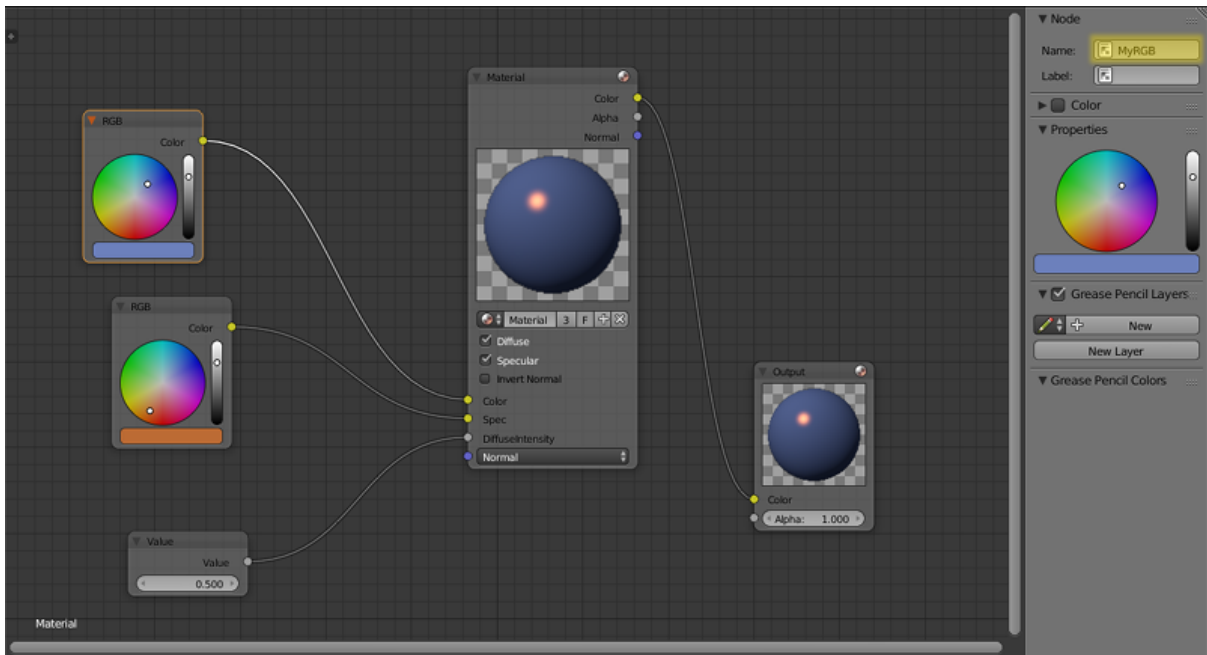

These two examples show how the parameters of a node material can be adjusted using API methods.

Getting node material parameters:

```
var m_scenes = require("scenes");
var m_material = require("material");

...

var cube = m_scene.get_object_by_name("Cube");

var rgb_node_1 = m_material.get_nodemat_rgb(cube, ["MyMaterial", "MyRGB"]);
var rgb_node_2 = m_material.get_nodemat_rgb(cube, ["MyMaterial", "MyRGB_2"]);
var value_node = m_material.get_nodemat_value(cube, ["MyMaterial", "MyValue"]);
```

Setting node material parameters:

```
var m_scenes = require("scenes");
var m_material = require("material");

...

var cube = m_scene.get_object_by_name("Cube");

m_material.set_nodemat_value(cube, ["MyMaterial", "MyValue"], 0.8);
m_material.set_nodemat_rgb(cube, ["MyMaterial", "MyRGB"], 0.7, 0.9, 0.3);
```

Same methods can also be used to adjust the scene environment, if the World object in the scene uses RGB or Value nodes. However, in this case you won't have to use the name of the material. The other difference is that a link to a scene object has to be replaced with a link to the World object that can be retrieved with the `get_world_by_name()` method:

```
var m_scenes = require("scenes");
var m_material = require("material");

...

var my_world = m_scene.get_world_by_name("World");

var world_rgb = m_material.get_nodemat_rgb(my_world, ["My_RGB_3"]);
```

Replacing Textures

API methods also allow you to replace texture images. This can be done using the `change_image()` method from the `textures` module:

```
var m_scenes = require("scenes");
var m_tex = require("textures");

...

var my_cube = m_scenes.get_object_by_name("Cube");

m_tex.change_image(my_cube, "My_Texture", "./test.png");
```

This method can be applied to replace textures used by the World object as well. However, in this case the name of the Texture node should be used instead of the name of a texture.

Inherit Material

Blend4Web supports dynamic material switching. This feature is exceptionally useful for so-called configurator applications that give a user an opportunity to customize the appearance of a model such as an apparel, a piece of furniture, a car or something else. The Inherit Material feature should be used when API methods for adjusting stack and node materials as well as the `change_texture` method do not suffice.

Inherit Material has the advantage of being flexible and easy to use, which makes it a better choice when you have to significantly alter the source material. It is available for both API scripts and logic nodes, and it can be used for stack and node materials alike. The downside of this feature is the fact that it might not work as fast as other methods described above, which can be critical in some cases.

Activation

To use Inherit Material, you need two objects. First one of them is the source object that has a material that will be inherited assigned to it. The second one is the target object which has a material that you need to replace. Both object should have the Dynamic

Geometry & Material option enabled (this option can be found under the Object tab, on the Rendering Properties panel).

Note: After a material is inherited, it will look exactly the same as if it was simply assigned to the target object in Blender. This means that you might have to manually prepare all UV maps and vertex color layers for every material that will be inherited by the object beforehand. For the source object, this is not necessary.

If you are using Logic Nodes, Inherit Material can be performed with the Object->Inherit Material node. If you are using API, this can be done with the `inherit_material` method.

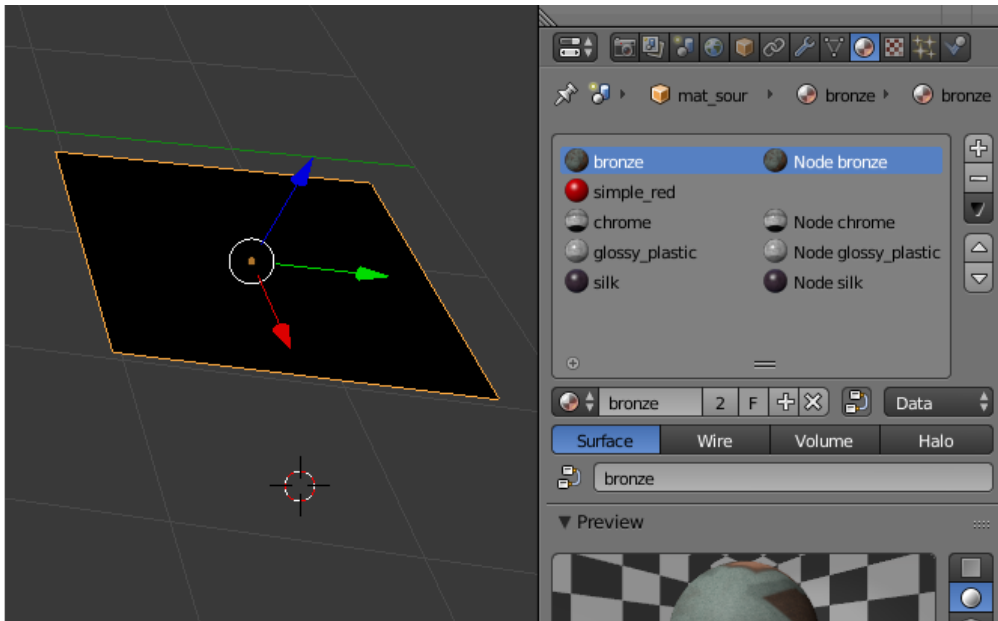

If an application requires many different materials to be changed, it might be a good approach to create a dedicated container object. It can be a simple flat mesh, like a Plane object, that has every material you might need assigned to it. This object can be hidden from the scene itself by setting the Hidden or Do Not Render option on the Object->Rendering Properties panel.

Material Library

Table of Contents

- Material Library
 - Library Structure
 - Material Structure
 - * Material Core
 - * An Example of Using a Material
 - Adding Material to a Scene
 - * How to Add a Whole Material
 - * How to Add Only a Material Core

The material library is a library where a user can find basic and the most commonly used materials to use in his or her projects or create his or her own materials based on these materials.

When creating a new project, you can plug the material library into it, and then plug in materials directly from there.

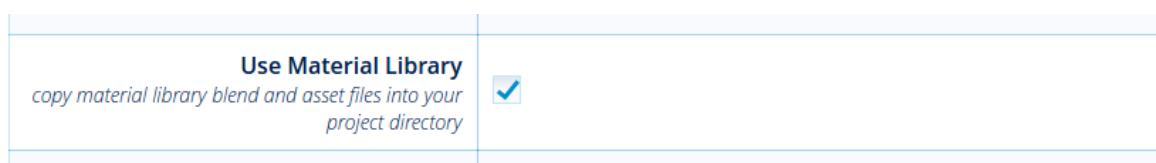

To do this, check the Use Material Library box when creating the project using the Project Manager. Then, an entire material library will be automatically copied to the /assets/material_library/ folder in the new project's directory.

Note: It is also possible to use Material Library in a pre-existing project. All you have to do is copy files from the /blender/material_library/ folder to the /assets/ folder in your project's directory. Then you can link the files that contain materials you need to your scene file and use them in the scene.

Note: Materials (or any other objects) can be both linked or appended to the scene.

The difference is described [here](#).

Library Structure

All materials are structured by folder (by categories of materials) and by a separate file (by materials). Every blend file contains one base material and a material for an additional object, that demonstrates the material on an object that can be associated with this material (for example, a gold ingot for a gold material).

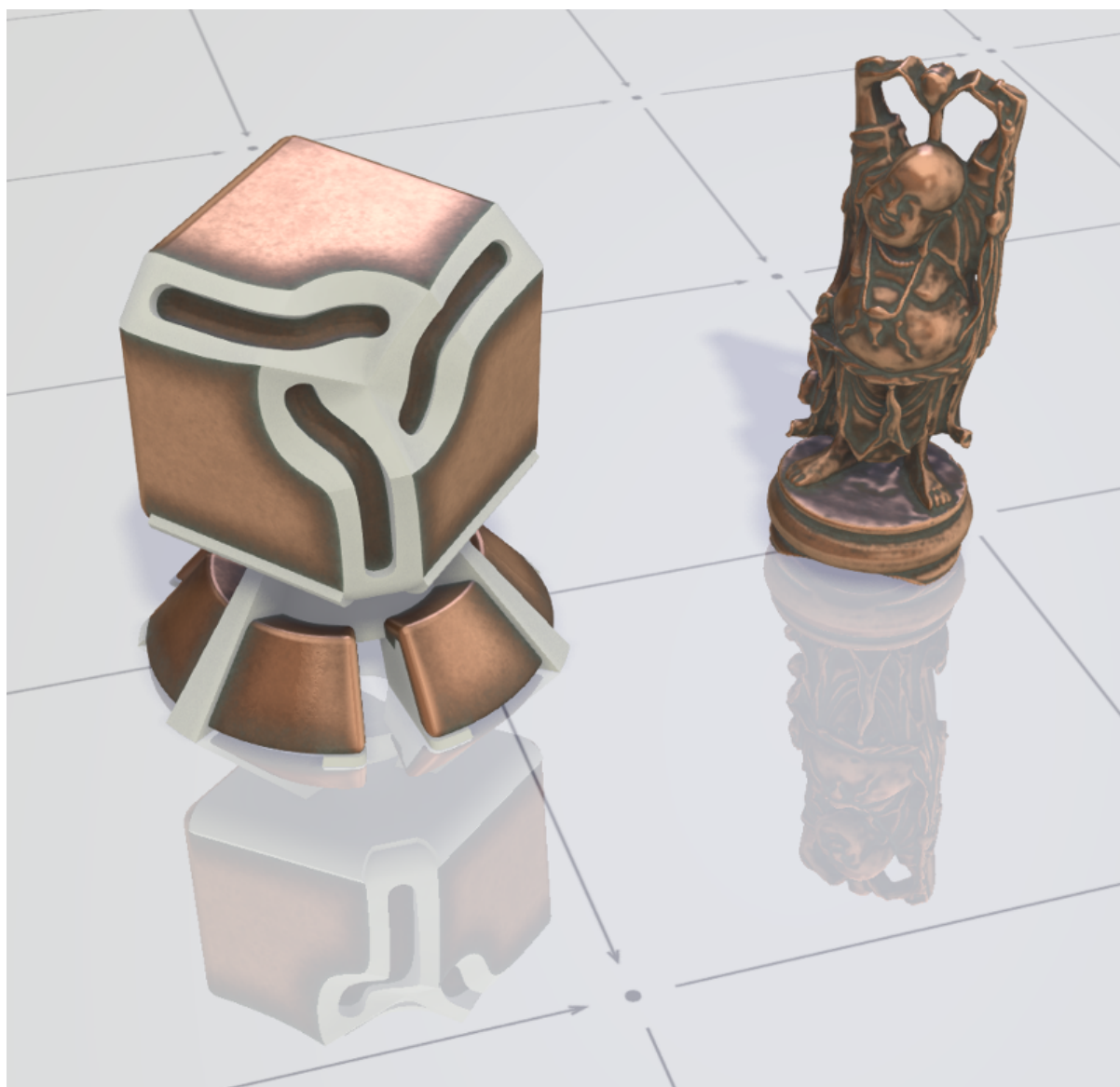

Material Structure



1. The core of the material
2. The Material node which receives all valuable information from the core.
3. The normal map that can be plugged into any material core.
4. Texture containing additional masks important for the material on the surface of the object to behave correctly. Most materials use the following masks:
 - Ambient occlusion map
 - Dirt map
 - Worn map
 - Patina map

These masks are not used in every material, only when they are needed for the shader to appear a specific way.
5. The Mapping node is used to control the parameters of the UV maps.
6. The RGB Curve nodes can be used to correct masks before plugging them into the material core.
7. Specific specular map settings are used right after the Material node to achieve various degrees of specular blur.
8. The baked ambient occlusion map is added to the shader right before the Output node.
9. The Output node.

Material Core

This is the main node group containing the node structure that form a shader. Essentially, this is the material itself in its true form, with all complex node interactions packed into one group for convenient use. This node group has certain inputs and outputs, as well as specific input parameters, to set it up.

An Example of Using a Material



Here, you can see an example of setting plastic material for a special demo object without using the textures that are plugged into the core of the material.

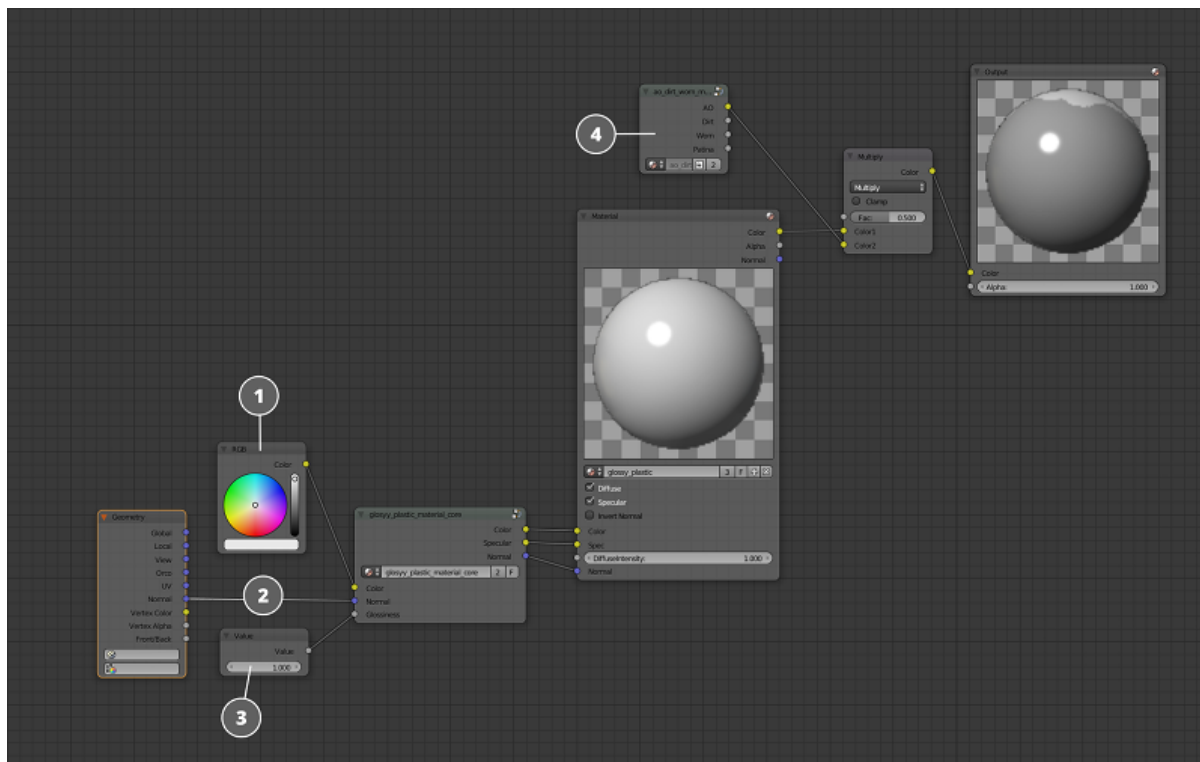

1. The base color is created with a simple RGB Color node and plugged to the material core input.
2. This implementation of the material does not use any normal maps, so geometry data is plugged to the Normal input.
3. The core of the material has a certain parameter that controls the amount of gloss on the material. In this case, the value of this parameter is set to maximum.
4. The material also uses a baked ambient occlusion map.

Now, let's take a look at a case of using the same material on a different object — a plastic gamepad.

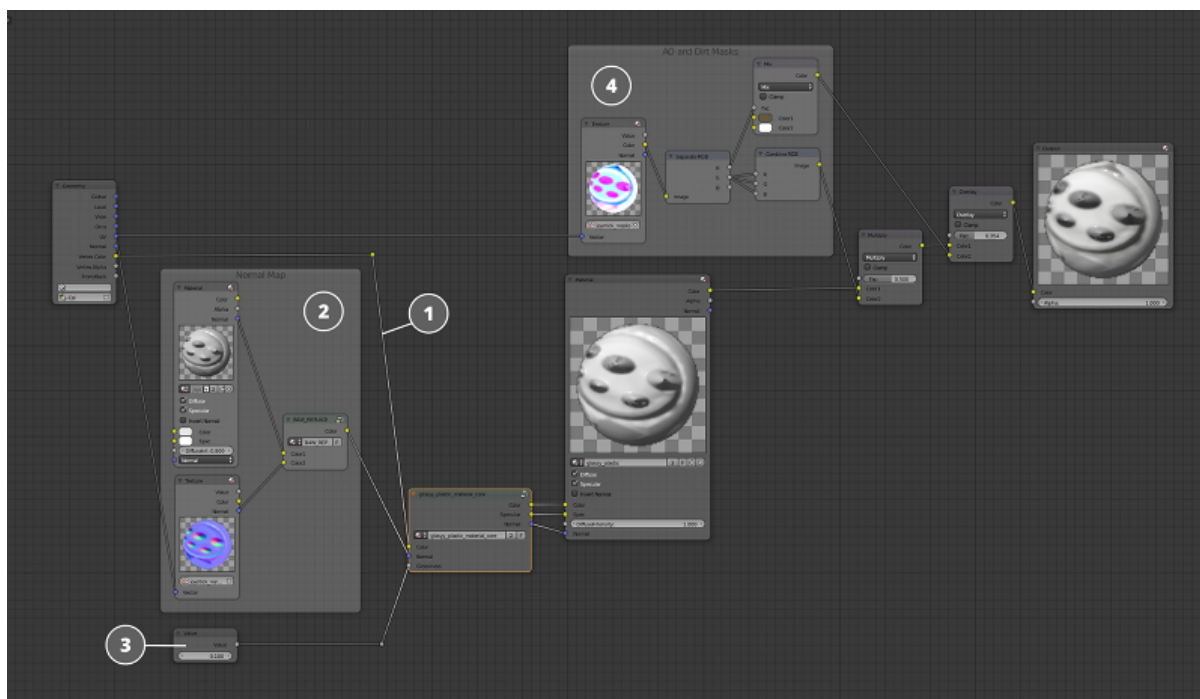

1. The vertex color from the geometry of the object is used as the base color here.
2. A normal map has been baked for the geometry of the gamepad, and connected to the Normal input of the material core.
3. The level of gloss is lower.
4. Instead of the masks from the demo model, the masks (ambient occlusion and dirt) baked specifically for the gamepad model are used.

Note: It should be noted that the material core hasn't changed and was not altered to fit different geometry.

Adding Material to a Scene

How to Add a Whole Material

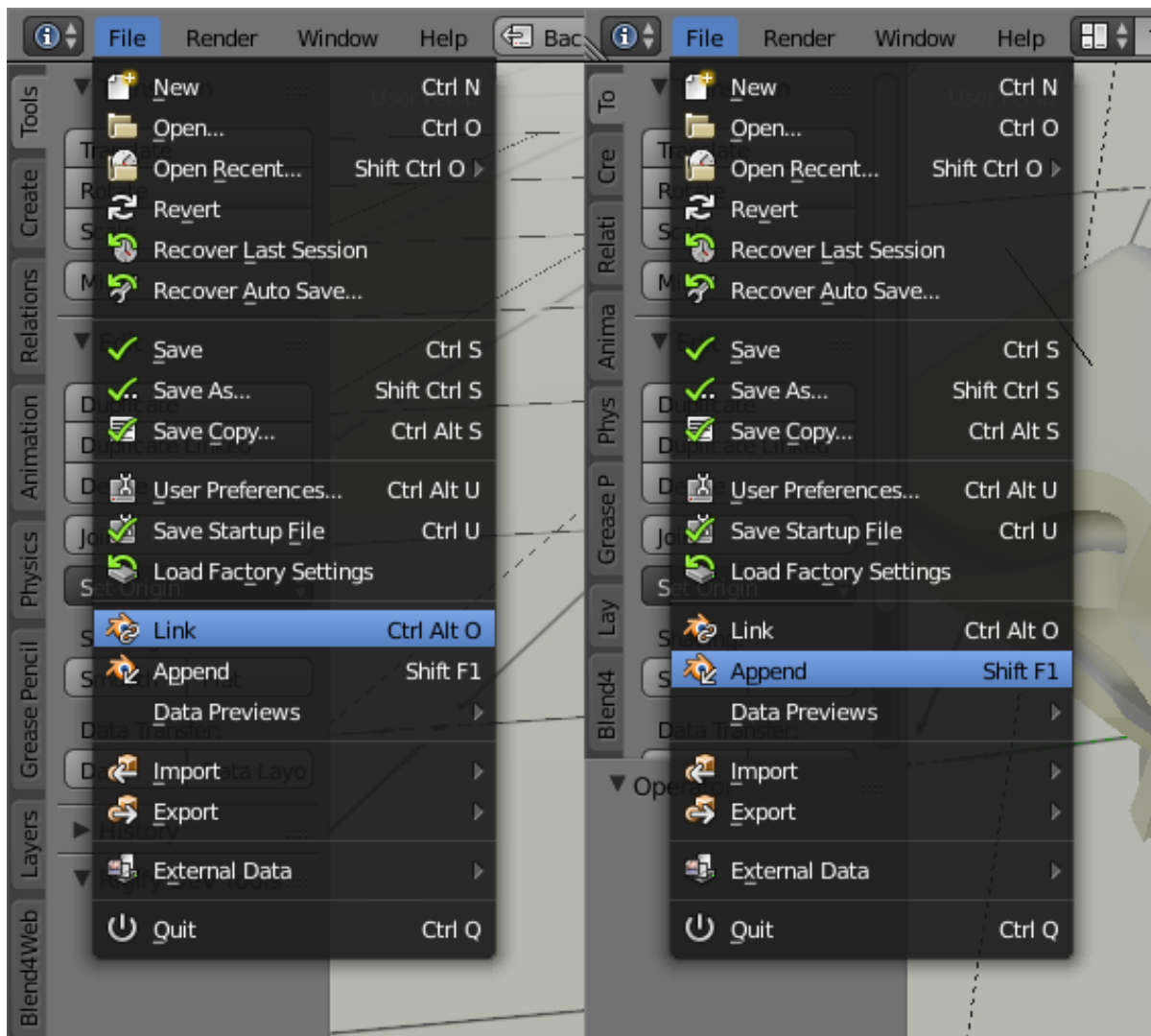

Select the File > Append/Link from the menu, depending on what you want to do. If you want to keep the ability to modify the object after it has been added to the scene, use Append. If you don't, use Link.

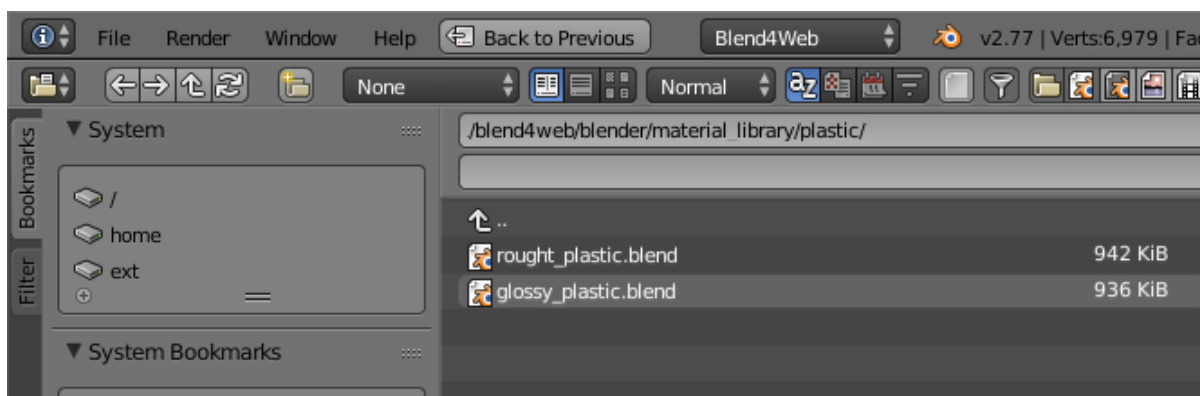

Then select the blend file containing the material you need from the `/blend4web/blender/material_library/` directory.

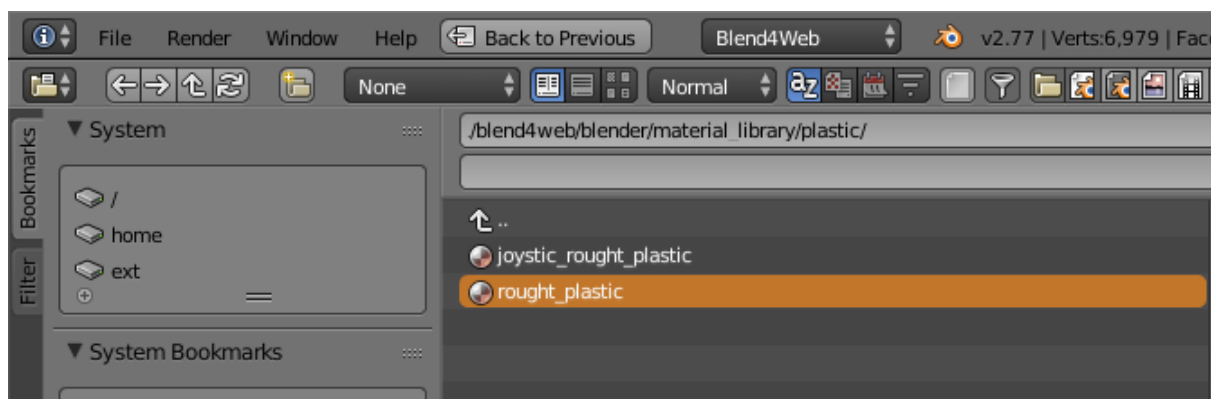

Select the material itself from the list of materials, and press Append from Library or Link from Library. Now, the material has been added to your scene and can be used on any object.

How to Add Only a Material Core

If you want to add only the core of the material and set everything else yourself, then, instead of selecting material, select NodeTree while linking/appendding, then select the node group you need, and press Append from Library or Link from Library.

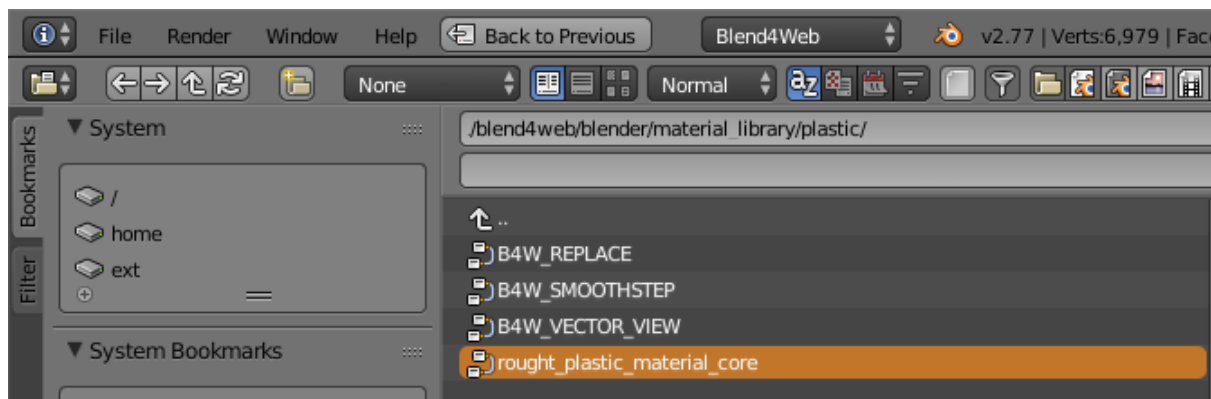

Now this node group can be found in the list of node groups that you can add to your material by clicking Add=>Group in the Node Editor interface.

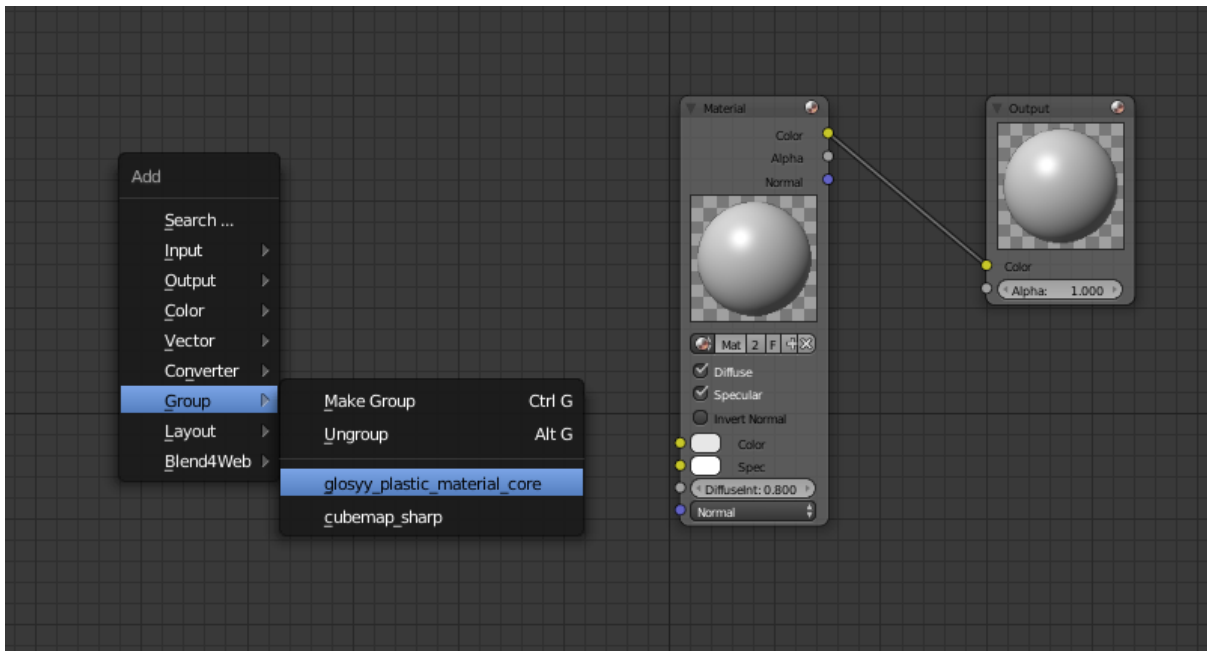

Note: Every material has its own requirements considering not only masks and textures, but also vertex colors and UV maps.

Node Materials

Table of Content

- Node Materials
 - Standard Nodes
 - Engine-Specific Nodes
 - * Clamp (B4W_CLAMP)
 - * Glow Output (B4W_GLOW_OUTPUT)
 - * Levels of Quality (B4W_LEVELS_OF_QUALITY)
 - * Parallax (B4W_PARALLAX)
 - * Reflect (B4W_REFLECT)
 - * Refraction (B4W_REFRACTION)
 - * Replace (B4W_REPLACE)
 - * Smoothstep (B4W_SMOOTHSTEP)
 - * Time (B4W_TIME)
 - * Translucency (B4W_TRANSLUCENCY)
 - * Vector View (B4W_VECTOR_VIEW)
 - * Linear to SRGB and SRGB to Linear (Deprecated)
 - Cycles Nodes
 - Limitations

Shader nodes extend significantly the potential of Blender’s standard materials by means of presenting shading as a batch of basic transformations.

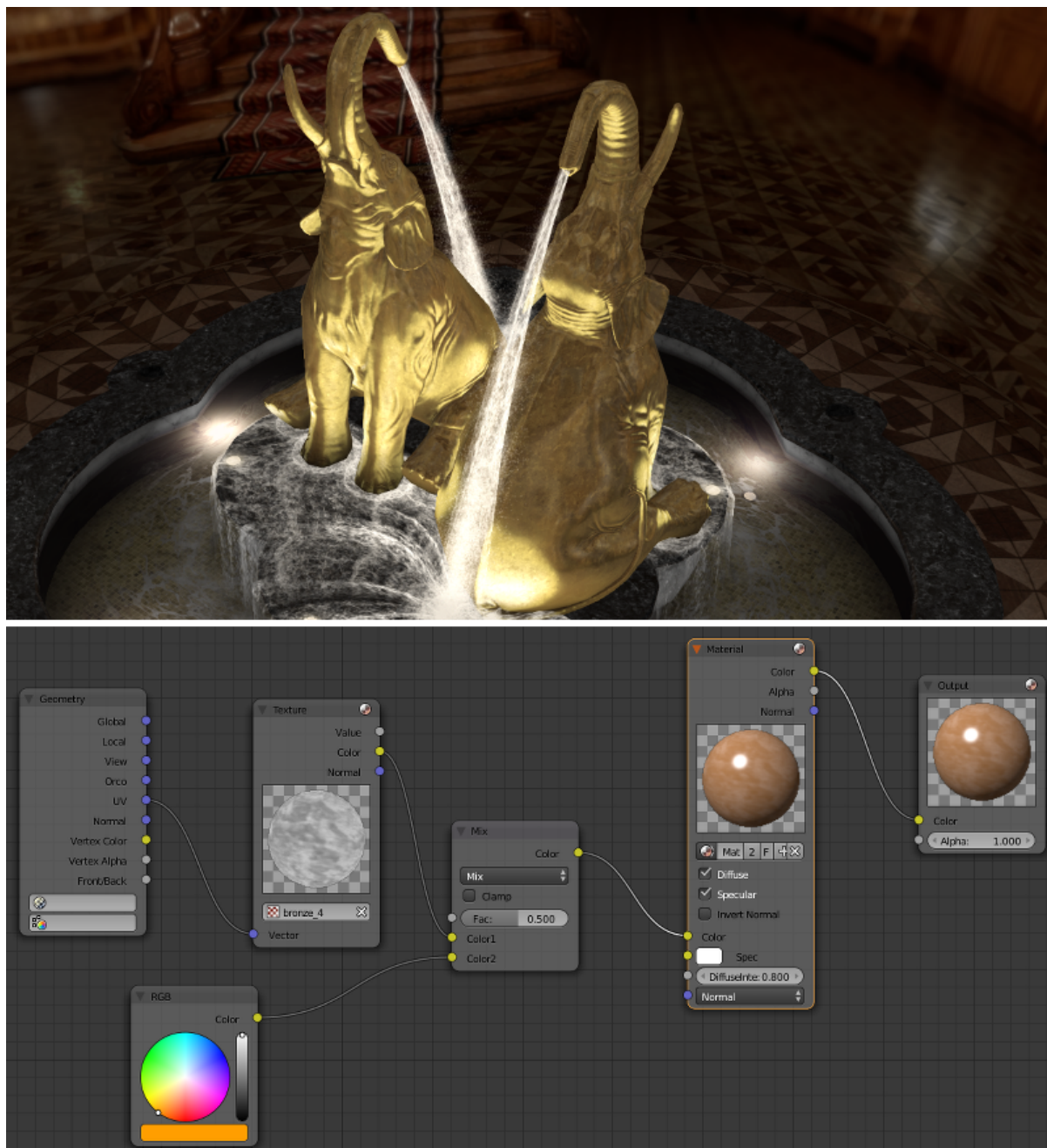

Standard Nodes

Blend4Web supports all standard Blender nodes, but some of them do not work fast enough and are not recommended to use in real time applications. Creating very complex materials, especially using large numbers of Geometry and Texture nodes, is also not recommended.

The engine also has partial support for some of the Cycles nodes. This subject is more thoroughly described in the [corresponding chapter](#).

Standard node performance and degree of support is described in the [table](#).

Please keep in mind that node materials have certain limitations concerning the number of specific nodes in the material. These limitations are described [here](#).

Engine-Specific Nodes

Engine-specific nodes extend functionality of the standard nodes to support extra features. These nodes are created as node groups (Node Groups or Node Tree) with specially determined names and input formats. For convenience, all special nodes are added to a blend file when it is opened.

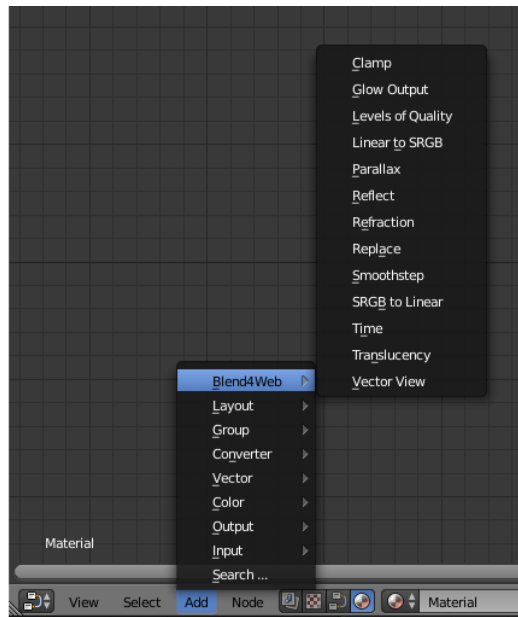

Clamp (B4W_CLAMP)

The node limits the output value. As a result all the output vector components take values from 0 to 1 inclusive.

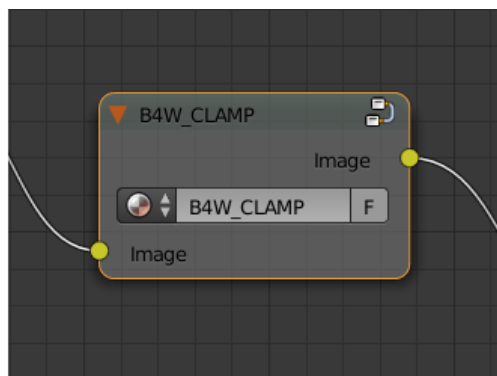

Input Parameters

Image Incident vector.

Output Parameters

Image Clamped vector.

Glow Output (B4W_GLOW_OUTPUT)

Applies the Glow effect to the node material. Besides the B4W_GLOW_OUTPUT node, the node material should have the Output node.

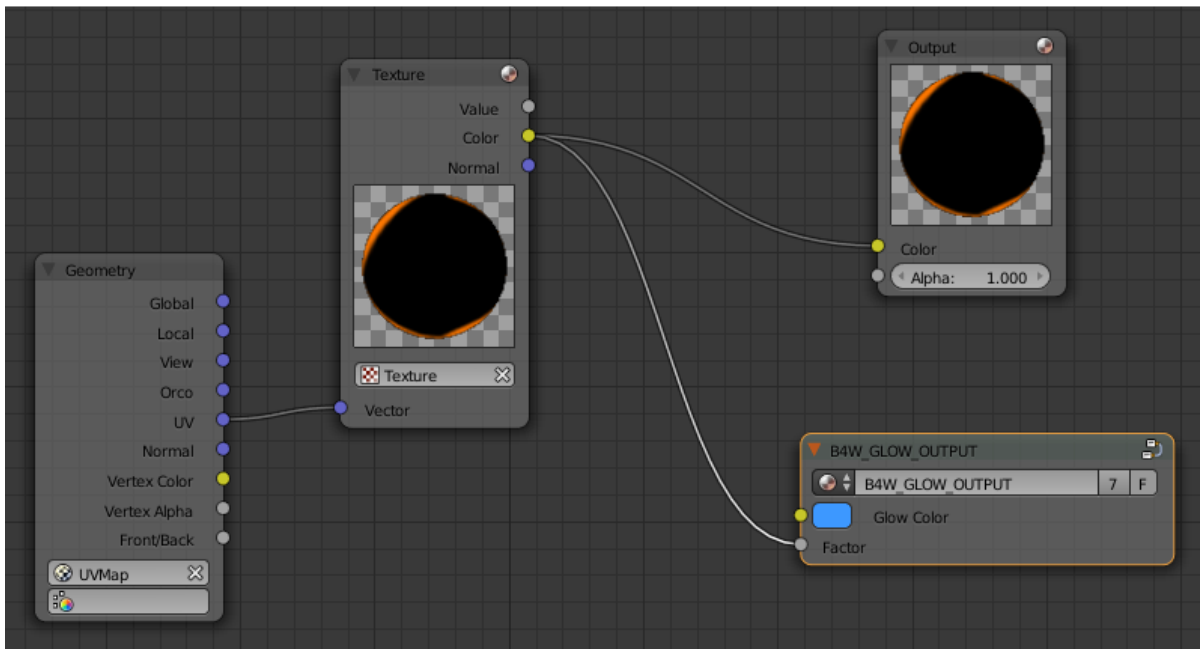
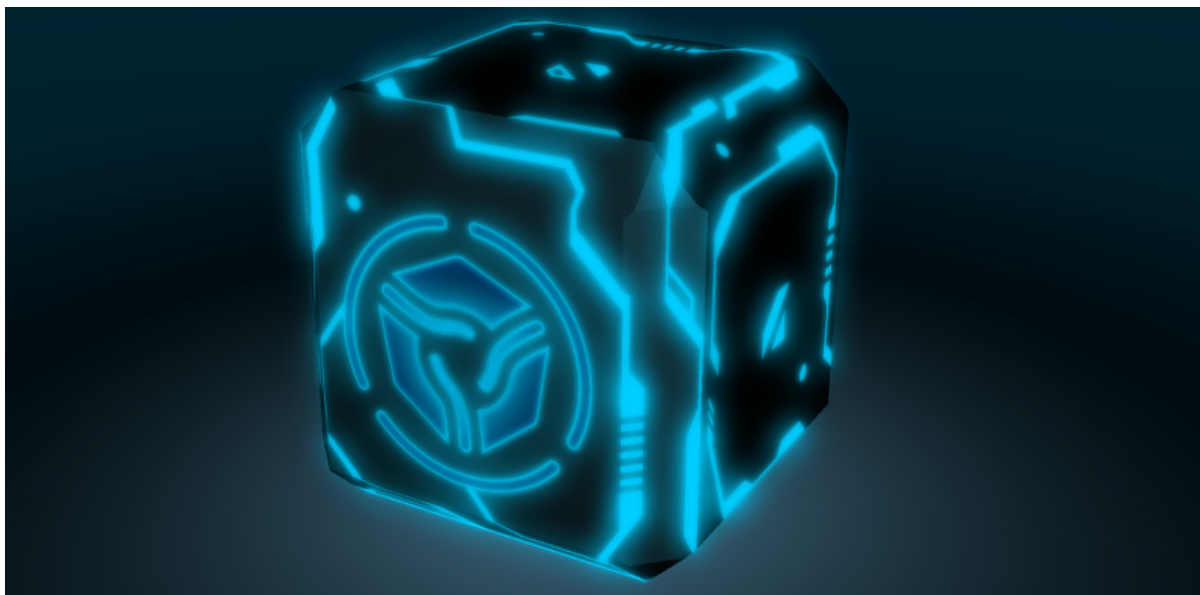

Input Parameters

Glow Color Glow color.

Factor Glow ratio. $\text{Factor} \in [0, 1]$.

- Factor = 0 - no glow.
- Factor $\in (0, 1]$ - there is a glow, colored with Glow Color.

Levels of Quality (B4W_LEVELS_OF_QUALITY)

Sets up the output color based on the current image quality settings. Can be used to, for example, replace complex material with more simple one if the application is running on a mobile device.

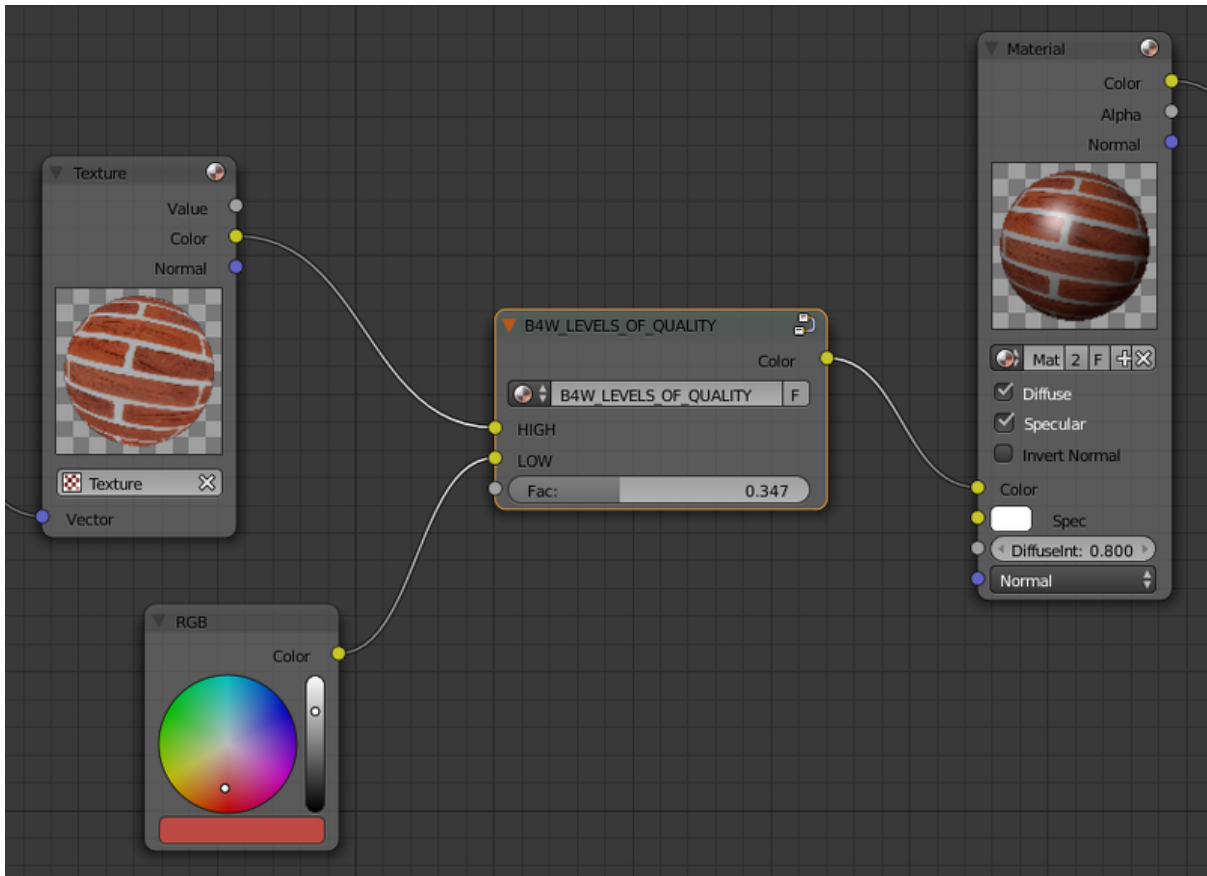

See also:

[Quality Profiles](#)

[Input Parameters](#)

HIGH Node links this parameter to Color parameter in case of high and maximum quality usage.

LOW Node links this parameter to Color parameter in case of low quality usage.

Fac This value specifies what quality setting (HIGH or LOW) will be visible in the Blender viewport. Can change from 0 to 1. If the value is lower than 0.5, the HIGH setting will be visible, if it is 0.5 or higher, the LOW setting will be visible.

Parallax (B4W_PARALLAX)

The node implements the texture coordinates offset using a height map.

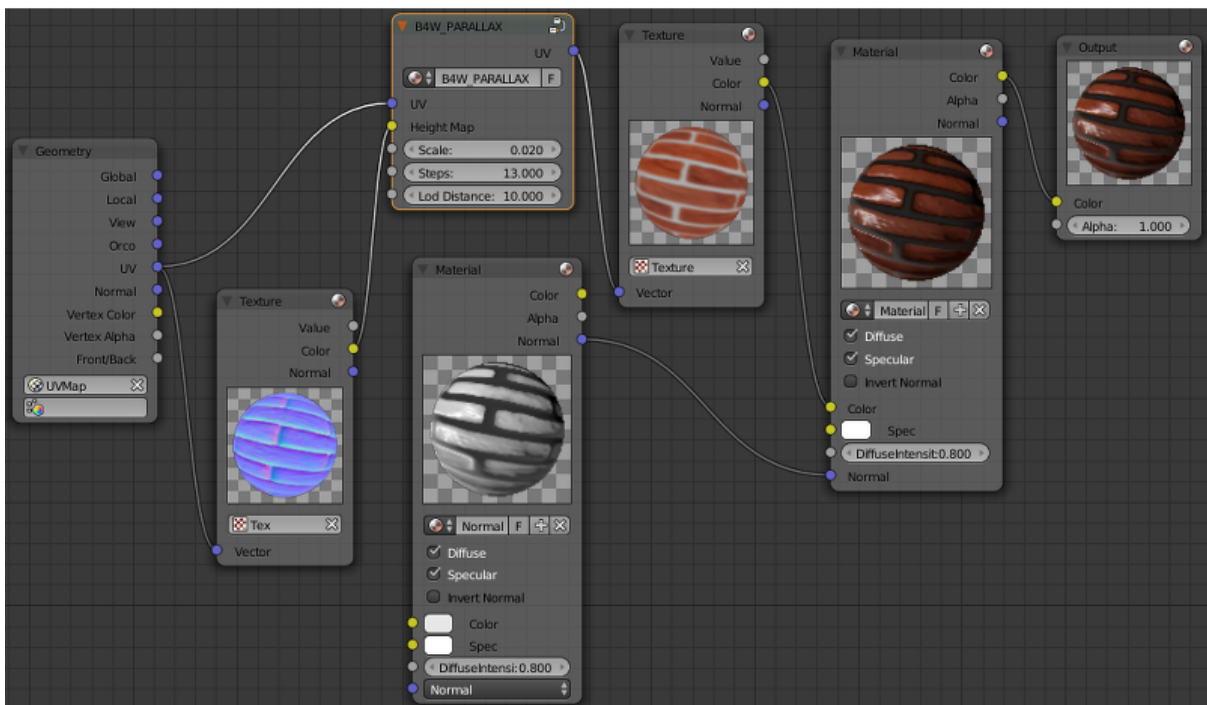
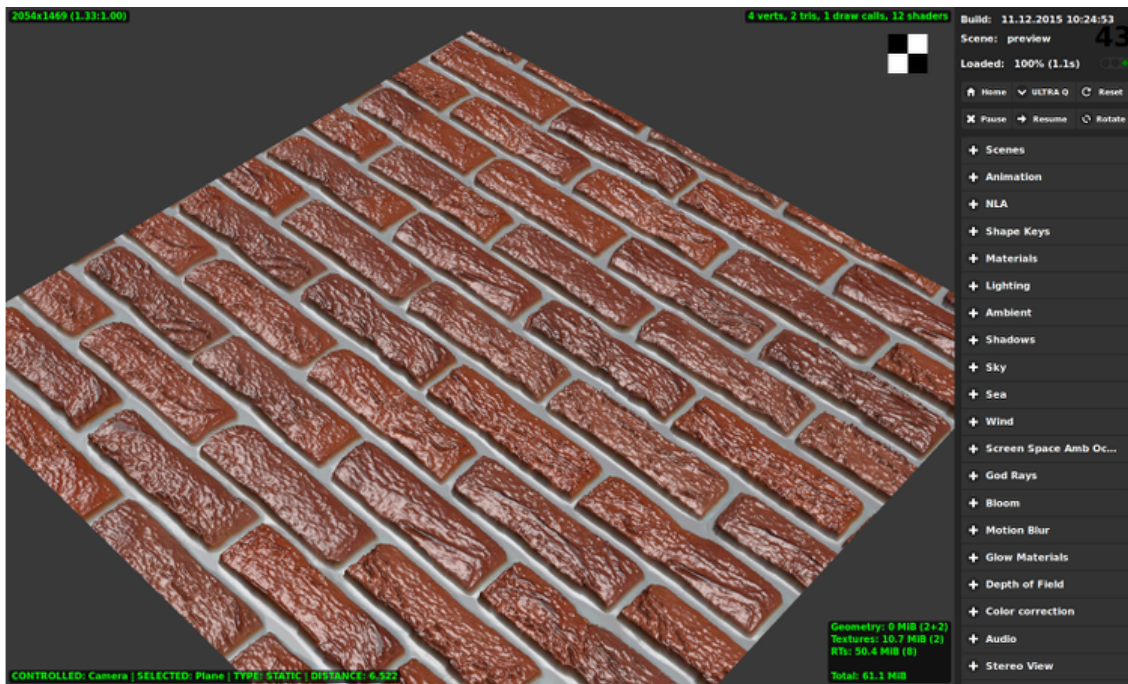

Input Parameters

UV Source texture coordinates.

Height Map RGBA texture with a height map packed into the alpha channel.

Scale Texture coordinates offset factor.

Steps The number of steps for iterative generation of texture coordinates offset. The bigger this value is the better is the final quality.

Lod Distance Maximum distance from camera at which the effect is observed.

Output Parameters

UV Resulting texture coordinates which are used as input for the texture nodes.

Reflect (B4W_REFLECT)

Calculates the reflection direction for an incident vector and a normal vector. Can be used to apply a cubemap to an object.

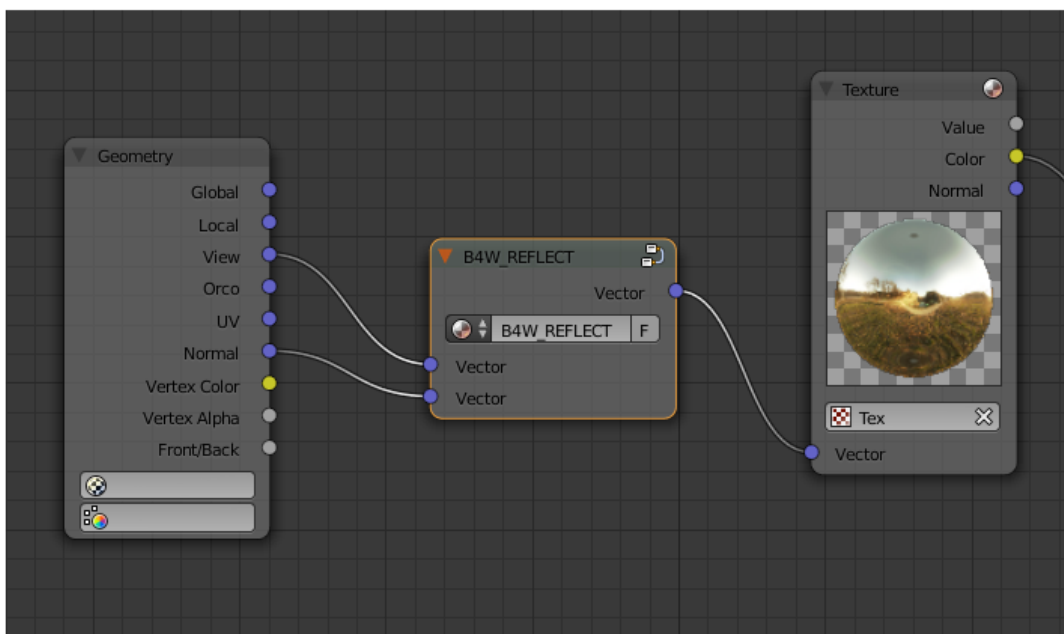

Input Parameters

Vector Incident vector. Should be connected to the View socket of the Geometry node.

Vector Normal vector. Should be normalized in order to achieve the desired result.
Should be connected to the Normal socket of the Geometry node.

Output Parameters

Vector Reflected vector. Should be connected to the Vector socket of the Texture node that contains the cubemap.

Refraction (B4W_REFRACTION)

Applies refraction effect to an object. This effect works only in the Blend4Web engine and not in the Blender's viewport.

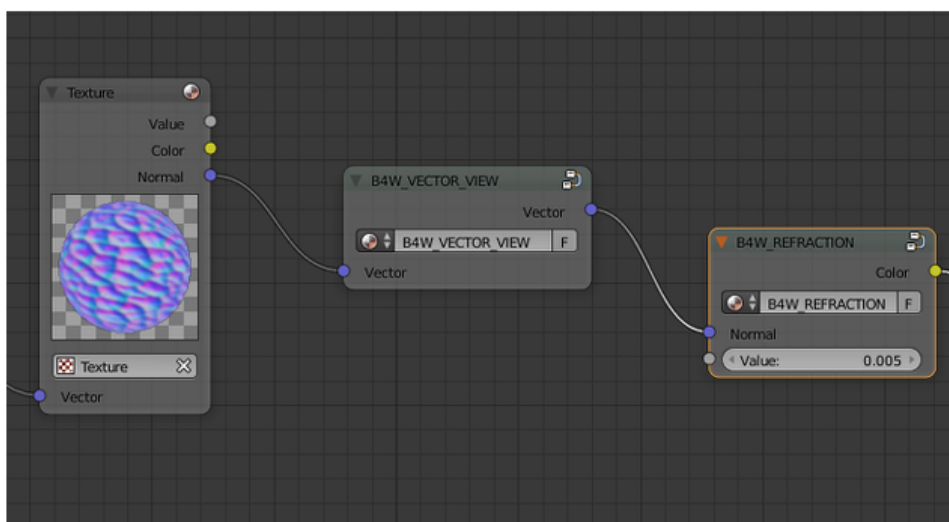
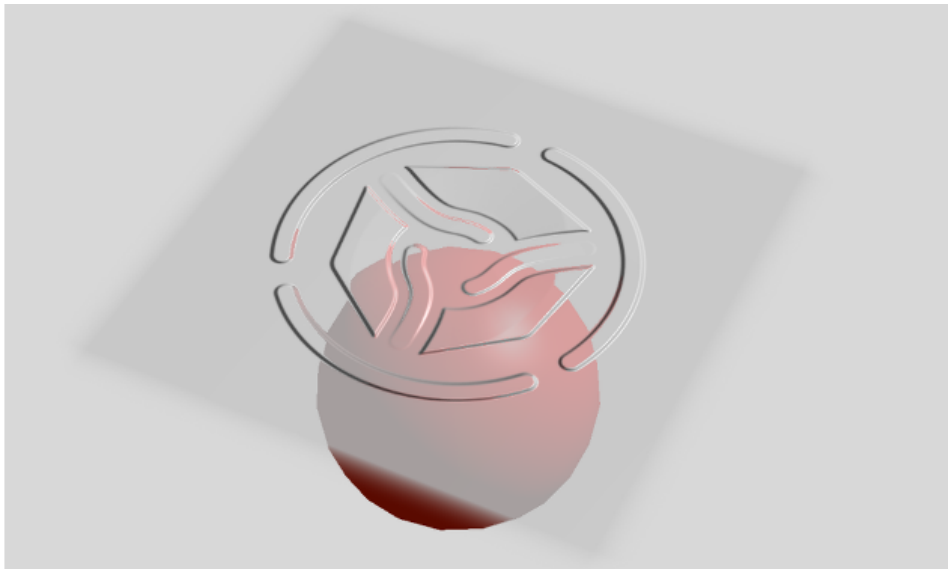

Input Parameters

Normal A normal vector in camera space for adding perturbations.

Refraction Bump Value Value of perturbation strength.

The default value is 0.001.

Output Parameters

Color Rendered texture behind object with perturbations.

Note: It's necessary to set the Refractions option from the Render > Reflections and Refractions panel to value AUTO or ON. The object's transparency type must be set to Alpha Blend.

See also:

[Transparency](#)

Replace (B4W_REPLACE)

The node replaces the inputs depending on the working environment (i.e. Blender viewport or Blend4Web). When working in Blender the Color1 input is connected to the Color output and the Color2 input is ignored. On the contrary when working in the engine the inputs are interchanged (the Color1 one is ignored and the Color2 one is connected to the output). The node is intended to display one node structure in the viewport and another - in the engine.

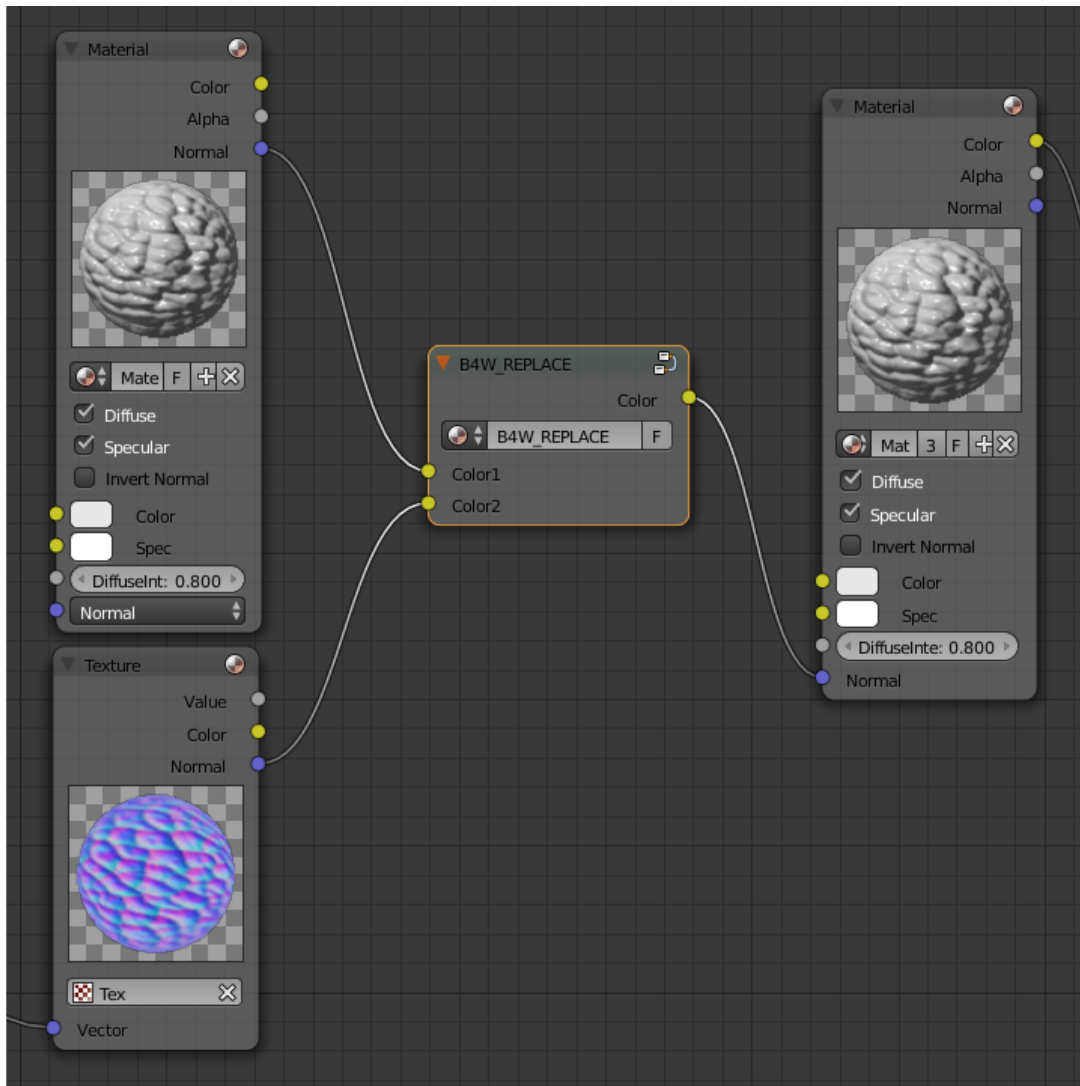

As a rule it is used for normal mapping. Blender's node materials do not support a tangent space of coordinates. Therefore, the only possible method to display normal maps in the viewport correctly is their usage inside the Material nodes.

Input Parameters

Color1 Node setup that will be visible in the Blender viewport.

Color2 Node setup that will be visible in the Blend4Web engine.

Output Parameters

Color Should be connected to the Color socket of the Material or Extended Material node.

Smoothstep (B4W_SMOOTHSTEP)

Performs smooth interpolation between two input values based on first value.

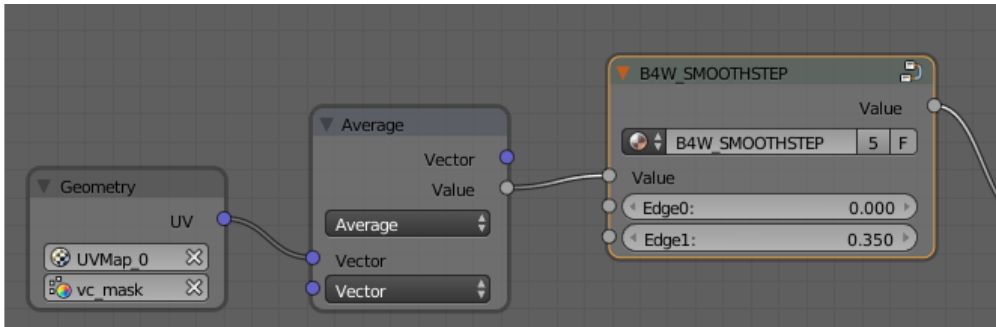

Input Parameters

Value Value which determines interpolation smoothness.

Edge0 First interpolation value.

Edge1 Second interpolation value.

Output Parameters

Value Interpolated value.

Note: For the correct interpolation input Value had to be between Edge0 and Edge1.

Time (B4W_TIME)

Provides the timeline counting from the engine start (in seconds). Can be used for animating any parameters in node materials, such as UV coordinates, mixing factors, transparency etc.

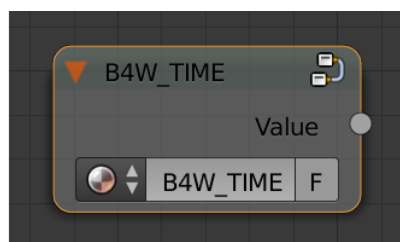

Input Parameters

None.

Output Parameters

Value Time (in seconds) elapsed from the engine startup.

See also:

[Animation of Value and RGB Nodes](#)

Translucency (B4W_TRANSLUCENCY)

The node implements a translucency effect (with respect to light sources only) for thin objects such as cloth, leaves, paper etc. The effect consists of two parts: 1) brightening of the object side which is opposite to the light source and 2) appearance of a light spot right in the light source place.

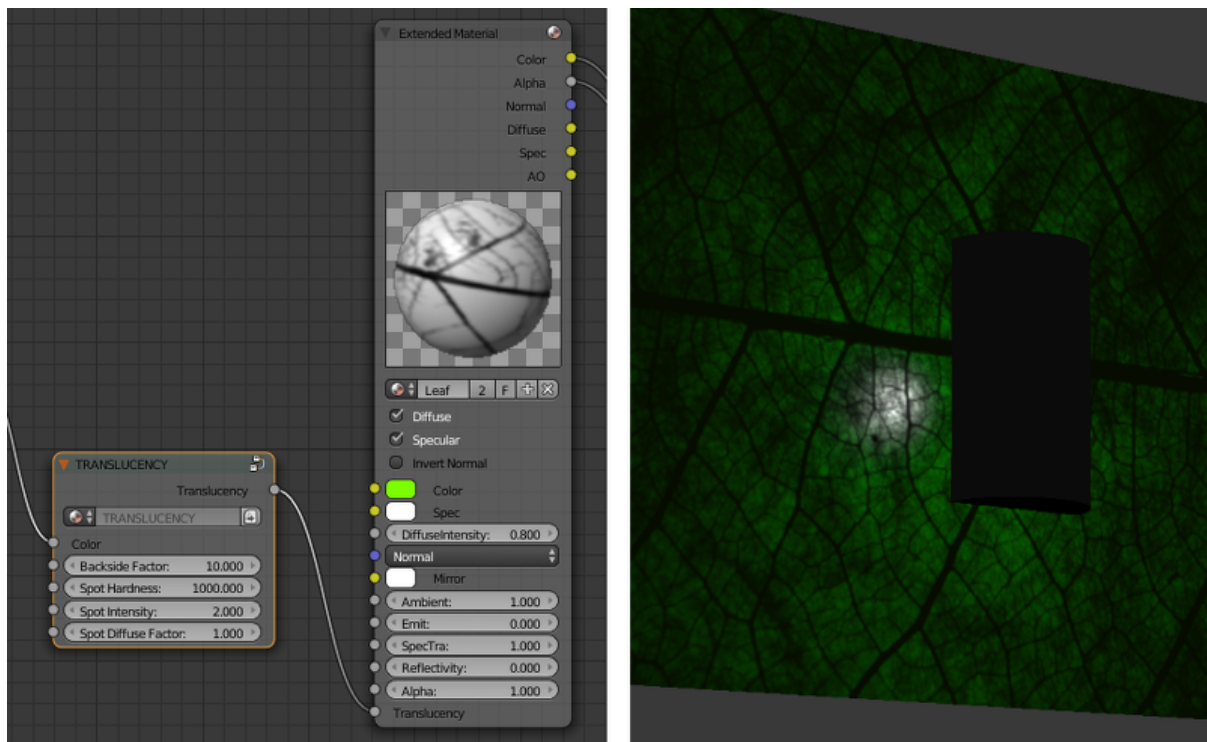

Input Parameters

Color One-channel texture which defines material heterogeneity - the white color denotes maximum translucency effect while the black color denotes its absence. White color is used by default.

Backside Factor Material color correction coefficient for the side which is opposite to the light source. It describes the color richness effect for the translucent areas.

- Backside Factor < 1 - brightening
- Backside Factor = 1 - no correction
- Backside Factor > 1 - darkening

The default value is 1.

Spot Hardness Light spot blurring factor. The bigger this value is the smaller is the spot and the sharper are the spot edges. The default value is 1000.

Spot Intensity Light spot intensity. The bigger this value is the brighter is the light spot.
The default value is 1.

Spot Diffuse Factor Material diffuse color influence on the light spot color.

- Spot Diffuse Factor = 0 - the light spot has the diffuse color
- Spot Diffuse Factor = 1 - the light spot color is white

The default value is 1.

Output Parameters

Translucency The output should be connected to the Translucency input of the Extended Material node.

Note: This node can work incorrectly, if the [mesh normals](#) were edited.

Vector View (B4W_VECTOR_VIEW)

The node transforms a vector into the camera's space of coordinates. Transformation is necessary because the engine defines most vectors in the world space of coordinates. If normal vector is being transformed by this node it should be used only for effects and not for connecting to the output of the Material or Extended Material nodes.

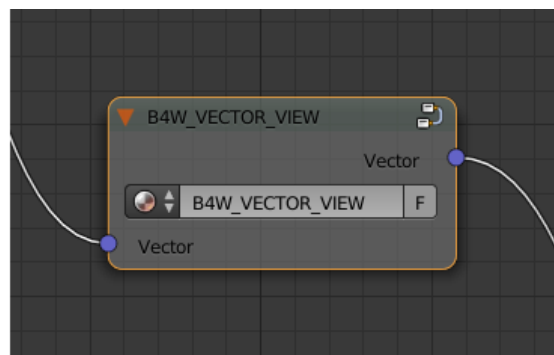

Input Parameters

Vector Vector coordinates in the world-space.

Output Parameters

Vector Vector coordinates in the camera-space.

Linear to sRGB and sRGB to Linear (Deprecated)

Converts colors from linear space to sRGB or vice versa. This function has been declared deprecated since the version 15.04. In the newer versions, the native Gamma node with the value of 2.200 should be used to convert color from sRGB to linear space, and the same node with the value of 0.455 to convert color from linear space to sRGB.

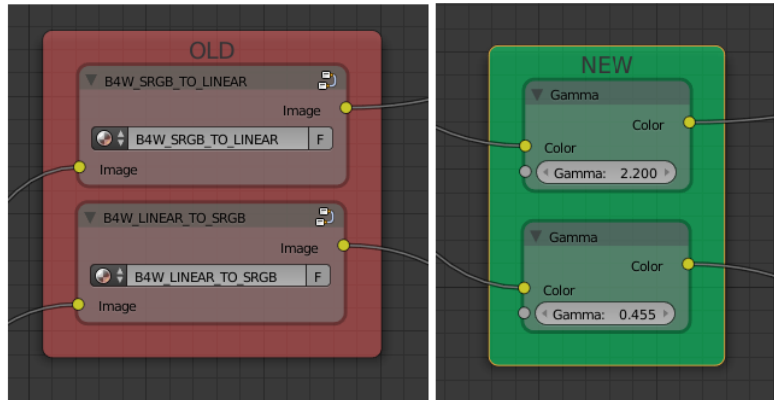

See also:

[Gamma in Node Materials](#)

Cycles Nodes

Note: Cycles node support is an experimental feature that is not yet recommended for using in production environment.

It should also be noted that using Cycles nodes in Blend4Web will produce images similar, but not identical to the ones created using Cycles renderer itself.

The engine support the following Cycles nodes:

- Material Output (only Surface and Displacement inputs are supported);
- BSDF Diffuse;
- BSDF Glossy (only GGX distribution is supported; the Roughness parameter does not influence the reflections);
- Transparent BSDF;
- Mix Shader;
- Fresnel;
- Layer Weight;
- Image Texture;
- Environment Texture;

- Object Info;
- Bump.

The following nodes are partially supported:

- Principled BSDF
 - Roughness, Metallic, Specular and Normal inputs are supported;
- Texture Coordinates (From Dupli parameter is not supported);
- UV Map (From Dupli parameter is not supported);
- Geometry (the Pointness and Parametric parameters are not supported).
- Emission (does not influence the lighting of the scene).

Cycles nodes are also supported for World object. However, at the moment node material does not affect the colors of the environment.

Other Cycles nodes will not, in most cases, work in Blend4Web the same way they do in Blender. They also might not work at all or even cause material in which they are used to work incorrectly. However, using these nodes will not cause instabilities in the application workflow.

Limitations

Node materials can be complex, but their complexity is limited by the capabilities of the hardware you use. It might not be noticeable most of the time, but if you are making a very complex material, you might exceed the number of textures and varying vectors (vectors that are used by a vertex shader to hand over data to a fragment shader) that your system allows to use in one shader. And even if you won't, some users of your application might not have devices as powerful as yours, so they can experience problems where you will not.

If you want to know how your scene would behave on a low-end device but don't have one in your possession, there is also a very useful option called Min Capabilities Mode. It is native to [Scene Viewer](#) and can be found on the [Tools & Debug](#) panel.

The number of textures and varying vectors supported by your device can be viewed on the WebGL Report web page accessible from the [SDK Index](#) page.

The two following tables list various material nodes along with the numbers of textures and varying vectors the engine allocates to them.

Varying Vectors

Node/Effect	Allocated Varying Vectors
Always reserved	3
Input -> Texture node (if the Normal output is used)	1
Blend4Web -> Parallax node	1
Vector -> Normal Map node	1
Input -> Material node (if the Shading -> Tangent Shading option is enabled on that material)	1
Input -> Geometry node (if the UV output is used)	1
Input -> UV Map cycles node	1
Input -> Texture Coordinate cycles node (if the UV output is used)	1
Input -> Geometry node (if the Vertex Color output is used)	1
Shadows on an object with the Alpha Blend material	1 - 4 (depending on the number of shadow cascades or shadow casters)
Shadows on an object with the "Opaque" material Refraction effect on a material Plane Reflections enabled on an object	1
Refraction effect on a material	2

Textures

Node/Effect	Allocated Textures
Blend4Web -> Parallax node	1
Input -> Texture node	1
Texture -> Environment Texture cycles node	1
Vector -> Vector Curves node Color -> RGB Curves node Converter -> Color Ramp node	1 (the number of the nodes in the material doesn't matter)
Shadows on an object with the Alpha Blend material	1 - 4 (depending on the number of shadow casters and/or shadow cascades)
Shadows on an object with an Opaque material	1
Refraction effect on a material	2
World -> Environment Lighting -> Sky-Texture is enabled for a World	1
Reflection effect on an object	1

Logic Editor

Table of Content

- Logic Editor
 - Basics
 - Control Flow
 - Animation
 - Camera
 - Object
 - Operations
 - Sound
 - Network
 - Time
 - Layout
 - Debug
 - Other Features

Basics

Visual programming is performed by creating logic node tree in the node editor area in Blender. These nodes can extend the scene functionality significantly without any coding.



To activate logic on the given scene set the Logic Editor property in the Scene tab and append/select active node tree.

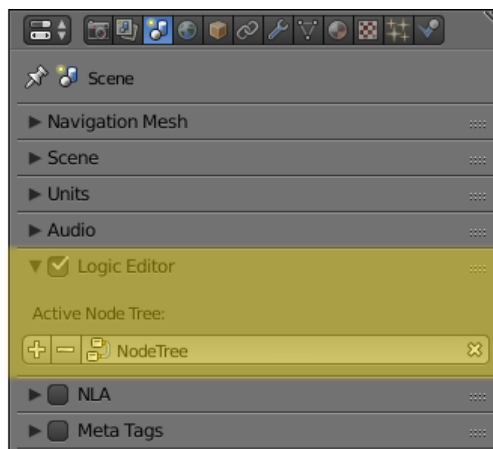

To edit logic tree go to the Node Editor area and select the Blend4Web Logic tree type:

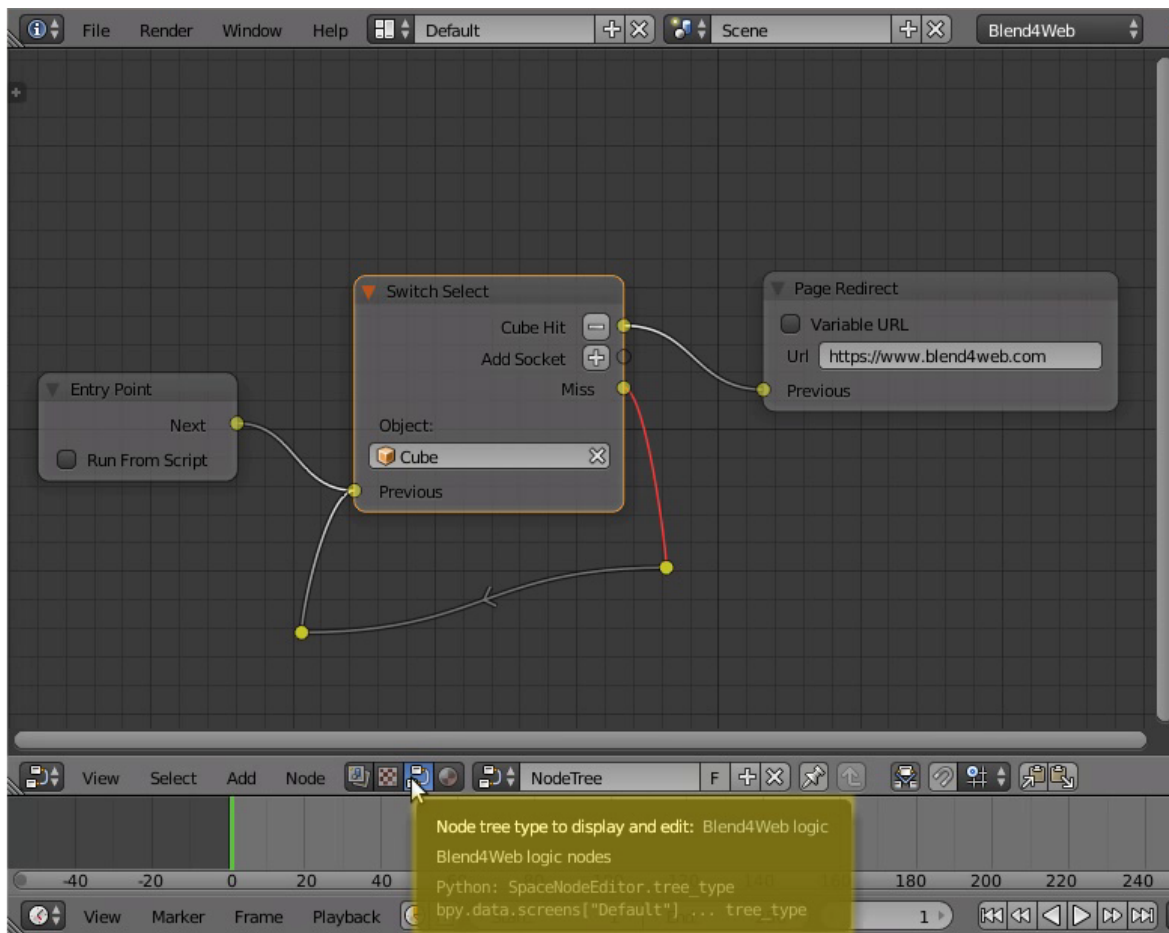

Then select the required node tree:

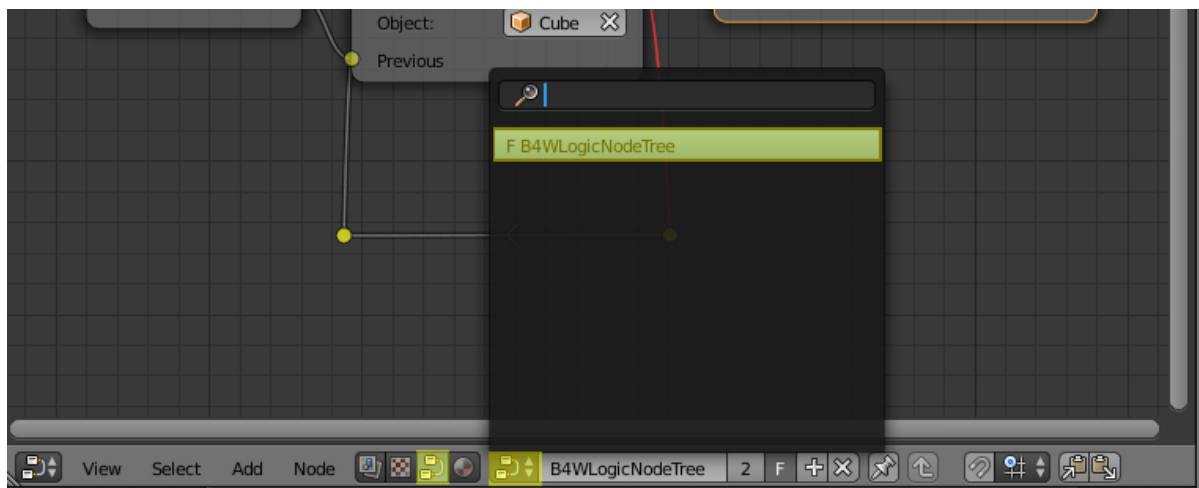

Nodes are created by using standard Blender keyboard shortcut Shift+A.

The nodes themselves are logic blocks that are executed from the Entry Point node which has no inputs and only one output. All other nodes have both inputs and outputs, and

can be inserted in any place of a logic tree. The exception is Page Redirect node, which can be inserted only to the end of the node tree. The nodes which have two outputs allow branching, thus the next leaf is selected based on condition specified for such nodes.

For implementing complicated logic there are variables that can have either numeric or string values. The variables can be used for storing some scene state (e.g. this can be a counter of animation playbacks, character's health points etc).

Logic Editor usage example:

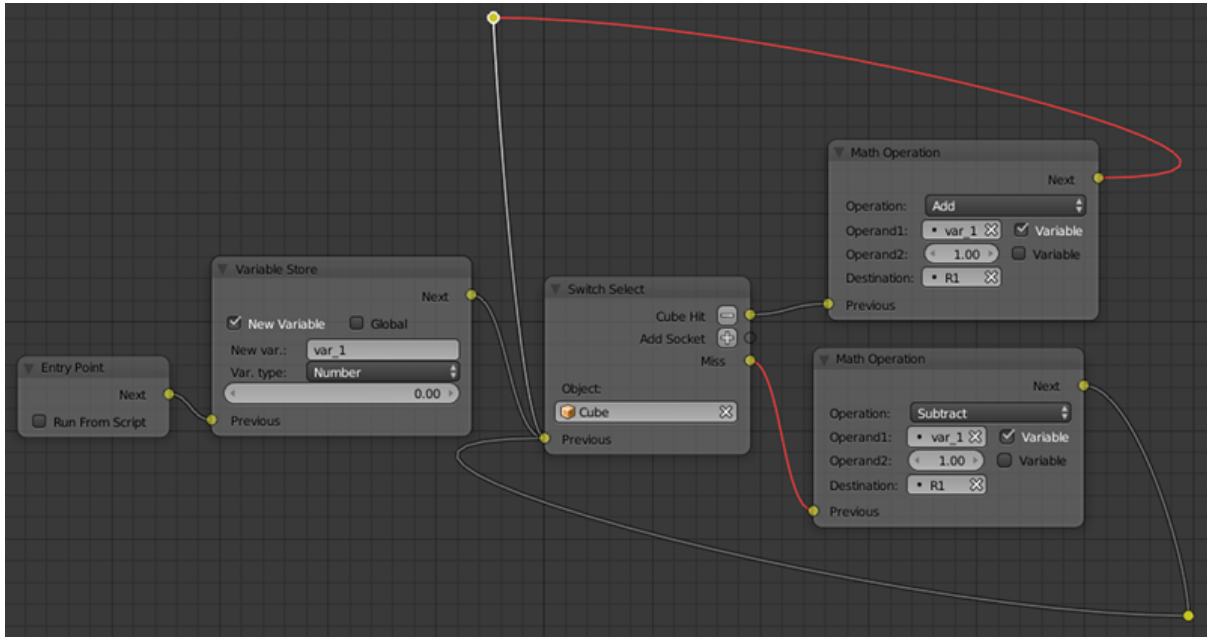

All available nodes are described below.

Control Flow

Entry Point

This is where the script starts. By using multiple entry points you can create multi-threaded applications.

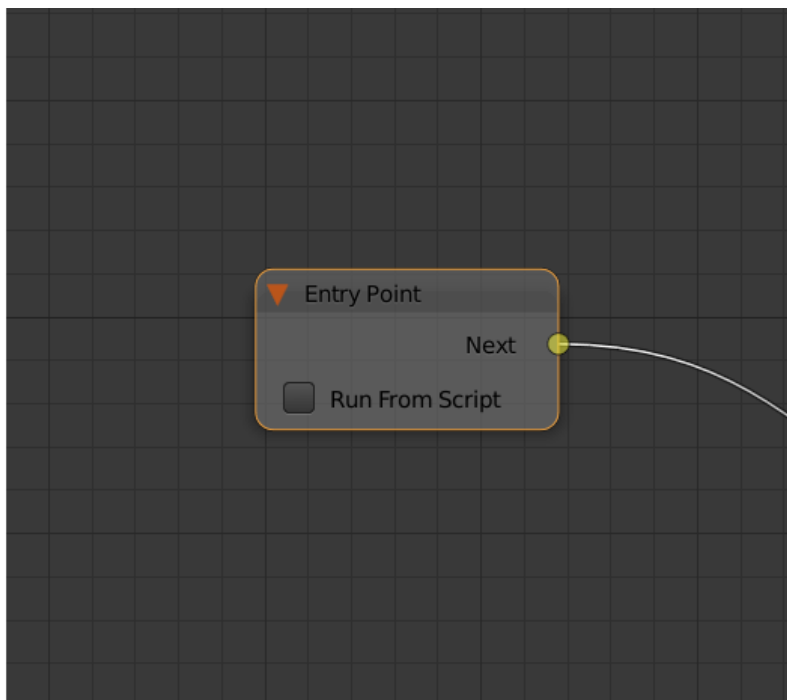

Input Parameters

None.

Output Parameters

Next Next node.

Internal Parameters

Run From Script If this parameter is enabled, the entry point can be triggered via API by using the `run_entrypoint` method.

Select

Can be used to trace the selection of any object from the object list.

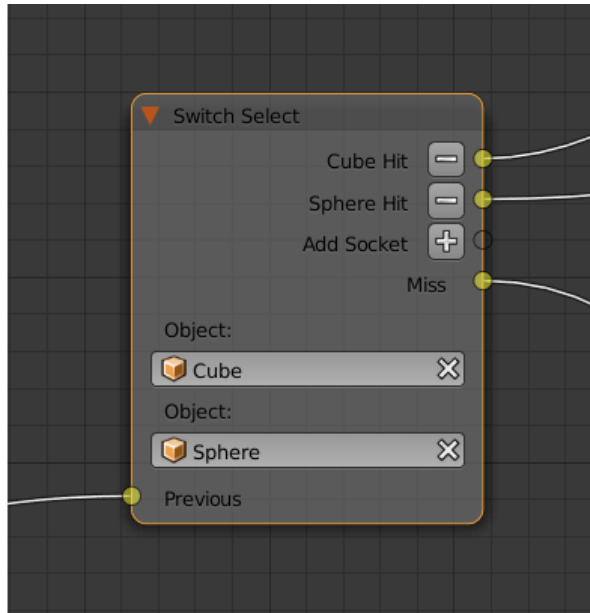

Input Parameters

Previous Previous node.

Output Parameters

<object name> Hit This parameter will pass the control to the next node if the user selects (with a mouse or by touch) an object mentioned in the parameter's name. The Select node has one such parameter by default, but you can add new ones and remove existing ones (the node can even have no such parameters).

Miss This parameter will pass the control to the next node when the user selects any object with the Selectable property enabled (or used by another Select node), but not specified in the Select node.

Internal Parameters

Object One of the objects that the user can select. These parameters are automatically created and deleted when you create or delete a Hit parameter. The number of such parameters is always equal to the number of the Hit parameters.

Variable If this parameter is enabled, you can specify an object variable in the corresponding Object field.

Destination Sets a variable that will be used to store a selected object after an event of selection.

Branch

Go to the specified node if the certain condition is met. The parameters (operands) can also be variables that are activated using the corresponding switches.

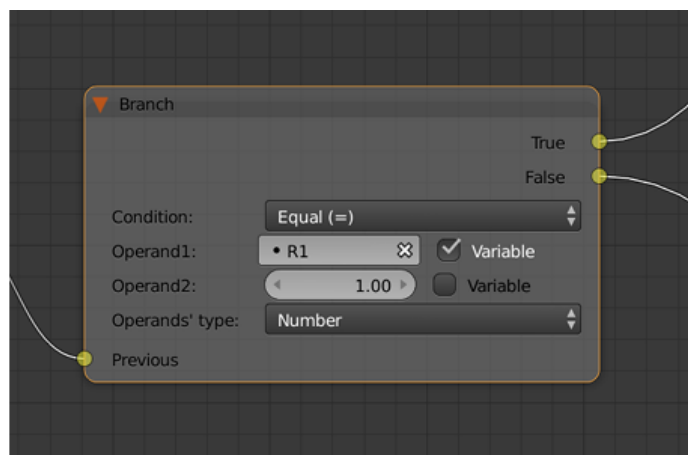

Input Parameters

Previous Previous node.

Output Parameters

True Condition is true.

False Condition is false.

Internal Parameters

Condition Logical condition. Can have one of the following types:

- Equal (=) - first operand is equal to the second.
- Not Equal (!=) - first operand is not equal to the second.
- Less Than (<) - first operand is less than the second.
- Greater Than (>) - first operand is greater than the second.
- Less Than Or Equal (<=) - first operand is less than or equal to the second.
- Greater Than Or Equal (=>) - first operand is greater than or equal to the second.

Operand1 First operand of the logical condition. Contains a numeric value or a string (if the String Operators parameter is enabled). Can be specified in the node or can be a link to one of the variables (if the Variable parameter at the right of it is enabled).

Operand2 Second operand of the logical condition. Works the same way as the first.

Operand's Type The type of the operands. Available values are Number (the default option), String and Object.

Switch

This node compares several variables with a given value and executes a conditional jump depending on the outcome.

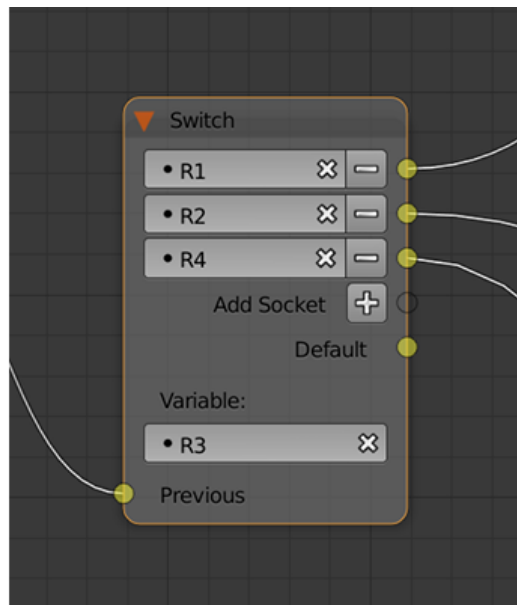

Input Parameters

Previous Previous node.

Output Parameters

<variable name> One of the variables used for comparison. If the value of the variable specified by this parameter is equal to the value of the Variable parameter, control is passed to the node connected to this output. The Switch node has one such parameter by default, but you can add new ones and remove existing ones (the node can even have no such parameters).

Default This output will pass control to the next node in case none of the values are equal to that of the variable set by the Variable parameter.

Internal Parameters

Variable Specifies a variable used for comparison.

JS Callback

Can be used to call custom JavaScript callback defined in your Blend4Web application.

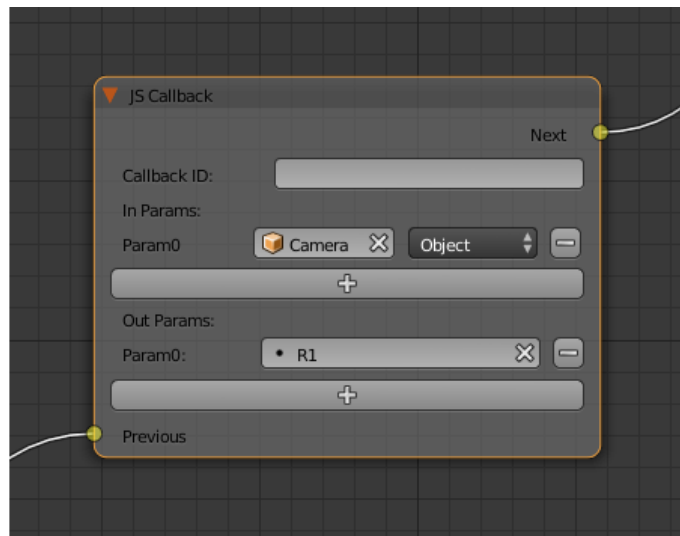

Input Parameters

Previous Previous node.

Output Parameters

Next Next node.

Internal Parameters

Callback ID The ID of a JavaScript function that will be called by the node.

This value can be set directly or via a variable (if the Variable parameter is enabled).

In Params A list of the input parameters of the function. Each parameter can be either a variable or a link to a scene object. The number of the input parameters can be adjusted. By default, this list is empty.

Input parameters are transferred to the callback function as an array that servers as the first argument of the function.

Param <param_number> Specifies an input parameter. This parameter can be a variable (R1 by default) or a link to a scene object, depending on the value of the Type parameter (each one of these parameters always has a corresponding Type parameter).

Type The type of the corresponding input parameter. It can have one of the two values: Variable (in this case, one of the variables will be used as the parameter) and Object (a link to a scene object).

Out Params A list of the output parameters. Empty by default. The number of the output parameters can be adjusted.

An array that consists of the output parameters serves as the second argument of the callback function.

Param <param_number> Specifies one of the variables that will be used as an output parameter. By default, R1 variable is used.

Define Function

This node can be used to combine several logic nodes into a function - a subroutine that can be accessed from the main logic setup. This node always serves as a starting point of a separate node tree and thus feature no input parameters.

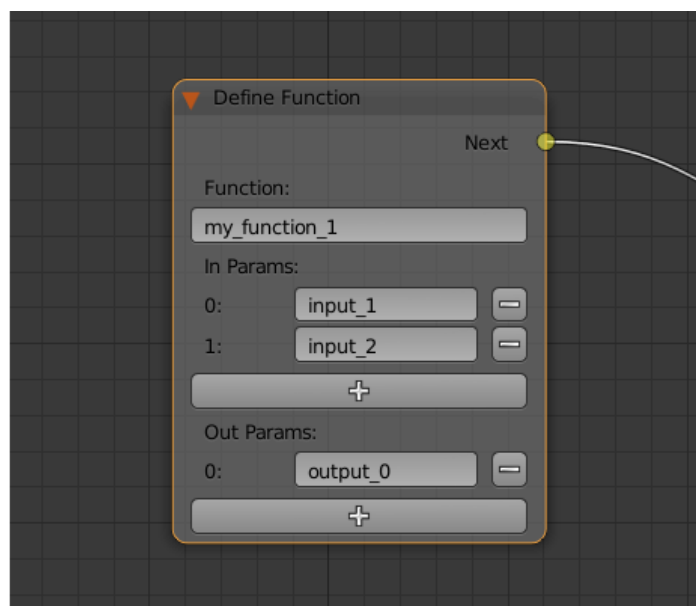

Input Parameters

None.

Output Parameters

Next Next node.

Internal Parameters

Function The name of the function.

In Params The list of the function's input parameters. This list is empty by default, but you can add and remove variables using + and - buttons. Each variable can also be named.

Out Params The list of the function's output parameters. Works in the same way as the **In Params** list.

Call Function

This node can be used to call a function defined by a **Define Function** node.

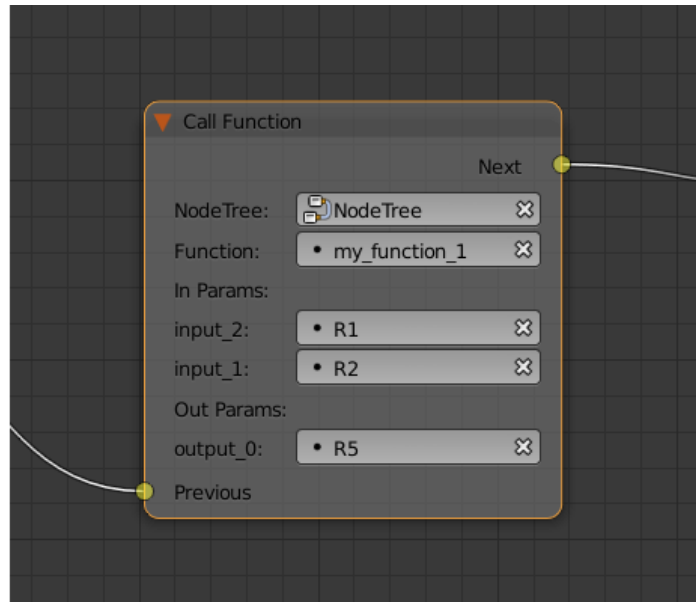

Input Parameters

Previous Previous node.

Output Parameters

Next Next node.

Internal Parameters

NodeTree The name of the node tree from which the function is called.

Function The name of the function.

In Params The list of the variables to set the input parameters of the function specified by the **Function** parameter.

Out Params The list of the variables to store the output parameters of the function specified by the **Function** parameter.

Animation

Play Timeline

This node can be used to control NLA animations. The Play Timeline node plays NLA fragment starting with a frame specified by the marker. Animation plays until next marker is encountered, or to the end of the scene's timeline. After that, control passes on to the next node.

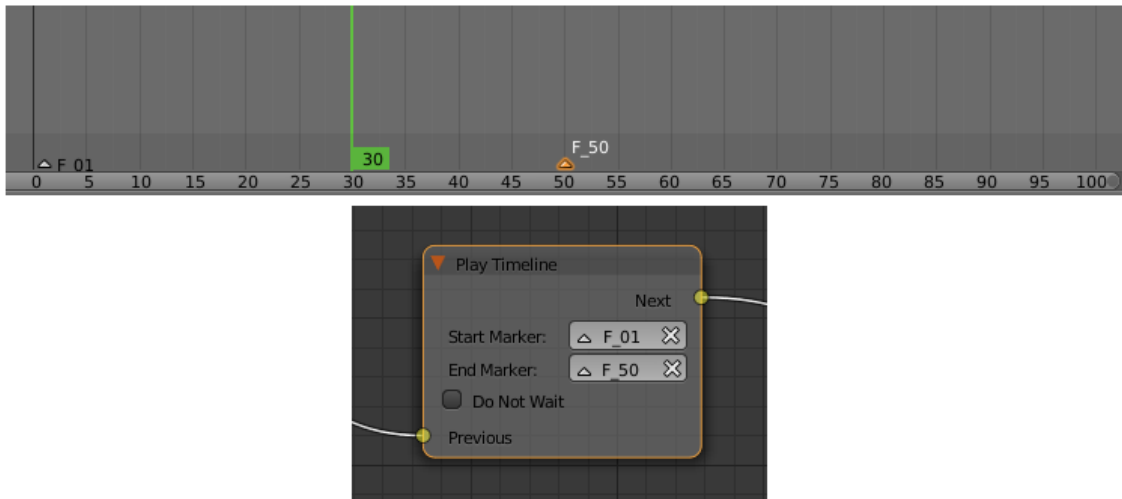

Input Parameters

Previous Previous node.

Output Parameters

Next Next node.

Internal Parameters

Start Marker First frame of the animation.

Note: If this parameter is not specified, the animation plays from the current frame, i.e. if animation hasn't been played yet, playback will start from the first frame of the timeline. If playback has been stopped with the Stop Timeline node and then started again, it will continue from the last played frame.

End Marker Last frame of the animation.

Note: If this parameter is not specified, an animation plays to the next marker (or to the end of the timeline, if there isn't any).

Do Not Wait If this parameter is enabled, the Play Timeline node will pass the control to the next node on starting the animation playback. If it isn't, the control will be passed to the next node only after playback is finished.

Stop Timeline

Stops the playback of the NLA animation started by the Play Animation node.

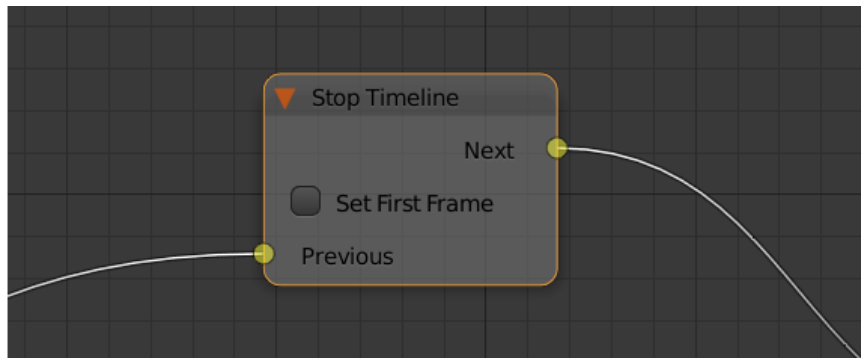

Input Parameters

Previous Previous node.

Output Parameters

Next Next node.

Internal Parameters

Set First Frame If this parameter is enabled, the timeline will be reset to the first frame after the animation playback stops. Otherwise, the timeline will be set to the frame specified by the End Marker parameter of the Play Timeline node.

Play Animation

This node can be used to play object animation.

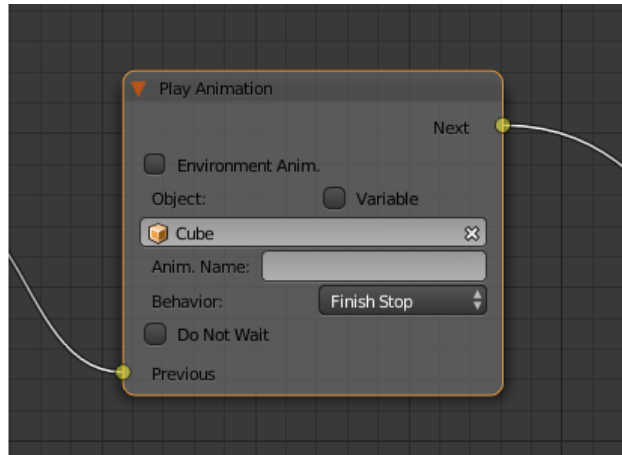

An animation can be one of the following types:

Regular Action:

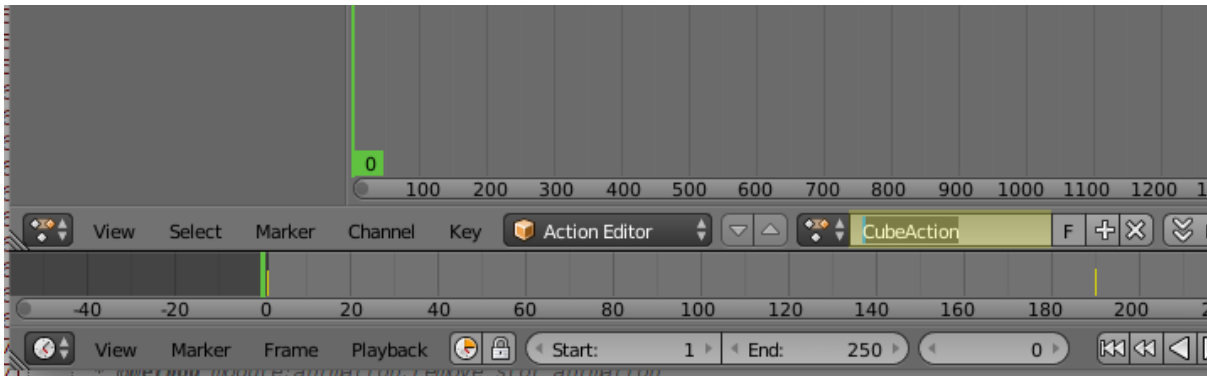

Shader Action:

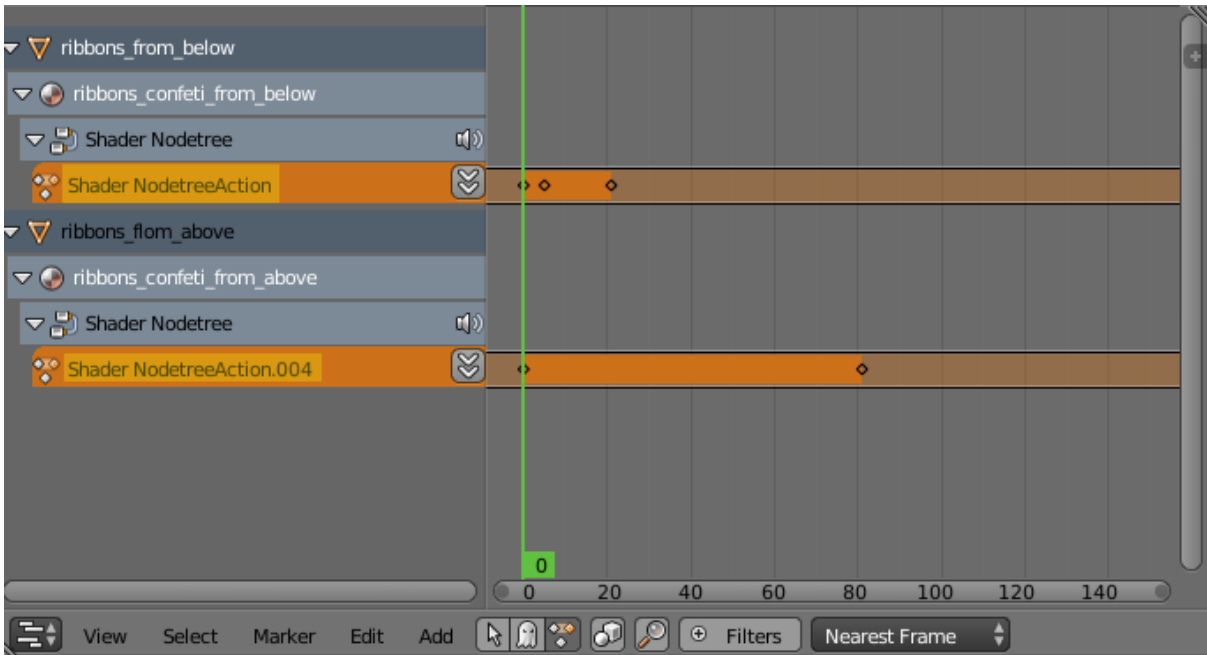

Particle system:

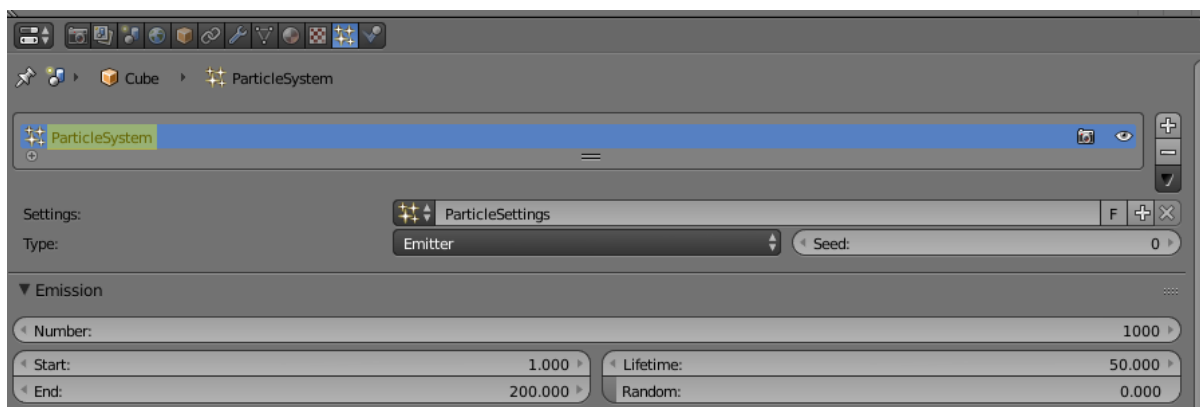

Input Parameters

Previous Previous node.

Output Parameters

Next Next node.

Internal Parameters

Environment Anim. If this parameter is enabled, animation of the scene environment (a World object) will be played.

World Specifies the World object, animation of which will be played. This parameter is only available if the **Environment Anim.** parameter is enabled.

Object Name Name of the object, animation of which will be played.

Variable If this parameter is enabled, an Object-type variable can be set in the Object field.

Anim. Name Name of an animation to play. If not specified, the entire timeline will be played.

Behavior Specifies animation behavior. Can have one of the following values:

- **Finish Stop** - animation will be played once.
- **Finish Reset** - animation will be played once, then the object will return to the starting point.
- **Loop** - animation will be playing repeatedly until it is stopped by the Stop Animation node.

Do Not Wait If this parameter is enabled, the Play Animation node will pass the control to the next node on starting the animation playback. If it isn't, the control will be passed to the next node only after playback is finished.

Stop Animation

Can be used to stop an object's animation.

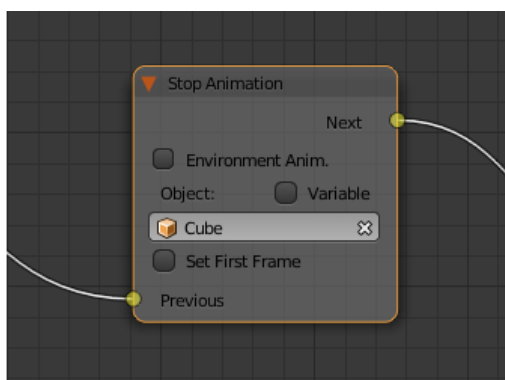

Input Parameters

Previous Previous node.

Output Parameters

Next Next node.

Internal Parameters

Environmental Anim. If this parameter is turned on, animation of the scene environment (a World object) will be stopped.

World Specifies the World object, animation of which will be stopped. This parameter is only available if the **Environment Anim.** parameter is enabled.

Object Name of the object, animation of which will be stopped.

Variable If this parameter is enabled, an Object-type variable can be set in the Object field.

Set First Frame Go back to the first frame after the animation has been stopped.

Camera

Move Camera

Can be used to move the camera, including smooth interpolation of its position.

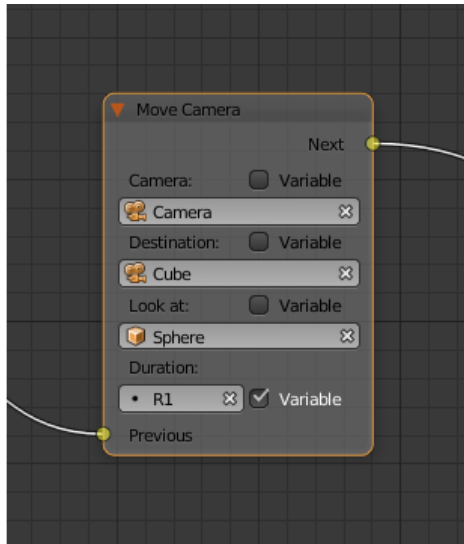

Input Parameters

Previous Previous node.

Output Parameters

Next Next node.

Internal Parameters

Camera A camera that will be moved.

This parameter can be set directly or using an Object-type variable (if the Variable option is enabled).

Location An object to which the camera will move. The camera's coordinates will be the same as the object's after the movement is finished.

This parameter can be set directly or using an Object-type variable (if the Variable option is enabled).

Target The camera will point in the direction of this object after being moved.

This parameter can be set directly or using an Object-type variable (if the Variable option is enabled).

Duration Time (in seconds) that the camera will spend being moved to a new location. Set to zero by default (and in this case the camera doesn't actually move, it simply changes its position). It can be specified manually or as a link to a variable (if the Variable parameter is enabled).

Set Camera Move Style

Can be used to change the move style of the selected camera.

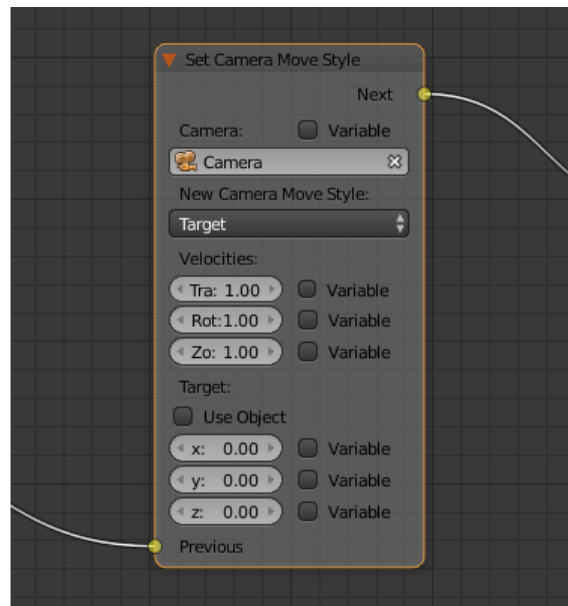

Input Parameters

Previous Previous node.

Output Parameters

Next Next node.

Internal Parameters

Camera This parameter specifies a camera to which the changes will be applied.

This parameter can be set directly or using an Object-type variable (if the Variable option is enabled).

New Camera Move Style This parameter specifies the new move style that the camera will use. Four options are available: Hover, Eye, Target and Static.

The following options are only available if the New Camera Move Style parameter is not set to Static:

Translation Sets the camera translation velocity. This parameter is set to 1.0 by default.

Rotation Sets the camera rotation velocity. This parameter is set to 1.0 by default.

Zoom Sets the zoom velocity of the camera. Default value is 0.10. Available only if the New Camera Move Style parameter is set to either Hover or Target.

The following parameters are used to specify a target or a pivot point of the camera and are available only if the New Camera Move Style parameter is set to either Hover or Target:

Use Object This parameter enables and disables using a scene object as camera's target or pivot point (depending on the camera type). If it is activated, a text field will appear to specify the object. This parameter is disabled by default.

If the Use Object parameter is disabled, the following three options become available:

- x The X component of the camera's target/pivot point.
- y The Y component of the camera's target/pivot point.
- z The Z component of the camera's target/pivot point.

Set Camera Limits

This node can be used to set limits of the selected camera. The node lists all available limits, but only ones that are compatible with the type of the camera are applied.

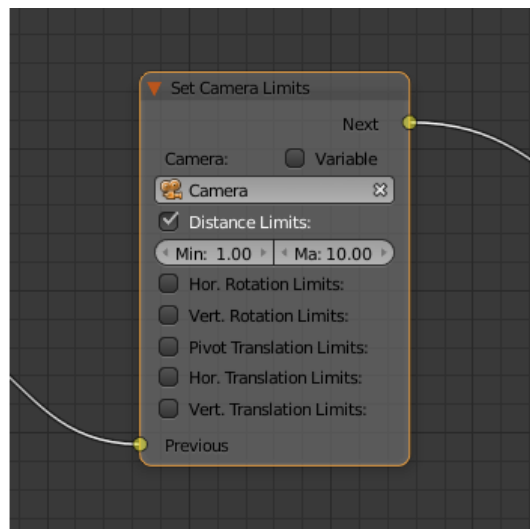

Input Parameters

Previous Previous node.

Output Parameters

Next Next node.

Internal Parameters

Camera This parameter specifies a camera to which the limits will be applied.

This parameter can be set directly or using an Object-type variable (if the Variable option is enabled).

Distance Limits Sets the Distance Limits parameter native to the **Target** and **Hover** camera types.

Hor. Rotation Limits Sets Horizontal Rotation Limits parameter native to **Target** and **Eye** camera types.

Vert. Rotation Limits Sets Vertical Rotation Limits parameter native to **Target**, **Hover** and **Eye** camera types.

Pivot Translation Limits Sets Pivot Translation Limits parameter native to **Target** camera type.

Hor. Translation Limits Sets Horizontal Translation Limits parameter native to **Hover** camera type.

Vert. Translation Limits Sets Vertical Translation Limits parameter native to **Hover** camera type.

Object

Show Object

Can be used to show 3D objects.

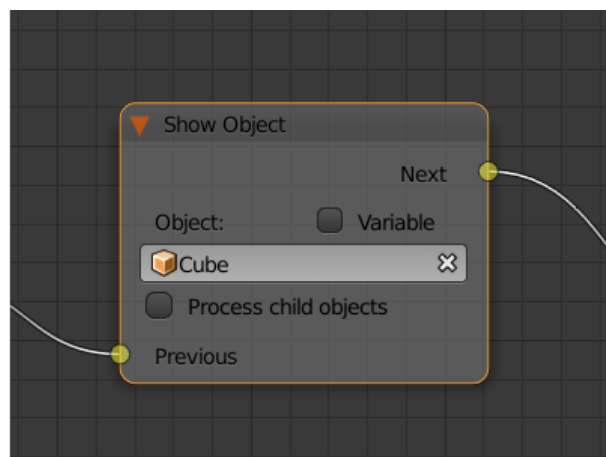

Input Parameters

Previous Previous node.

Output Parameters

Next Next node.

Internal Parameters

Object An object to show.

Variable If this parameter is enabled, an Object-type variable can be set in the Object field.

Process child objects If this parameter is enabled, child objects will be shown as well.

Hide Object

Can be used to hide 3D objects.

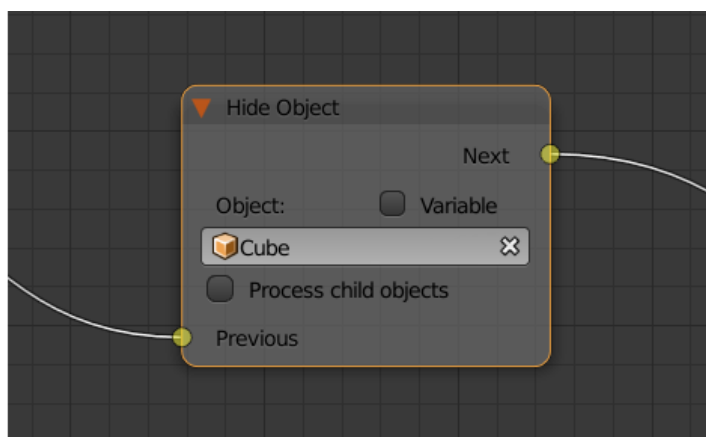

Input Parameters

Previous Previous node.

Output Parameters

Next Next node.

Internal Parameters

Object An object to hide.

Variable If this parameter is enabled, an Object-type variable can be set in the Object field.

Process child objects If this parameter is enabled, child objects will be hidden as well.

Transform Object

Can be used to transform object's location, size and rotation angles.

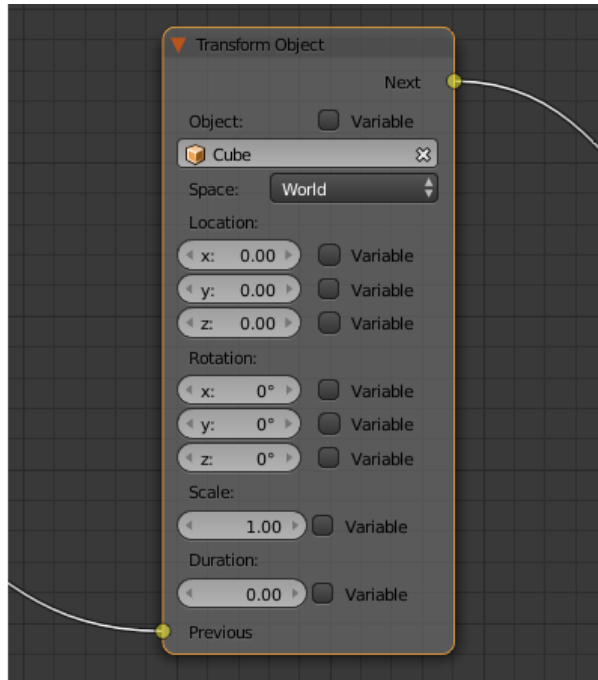

Input Parameters

Previous Previous node.

Output Parameters

Next Next node.

Internal Parameters

Object An object that needs to be translated.

Variable If this parameter is enabled, an Object-type variable can be set in the Object field.

Space This parameter defines the coordinate space that will be used to transform the object. It can have one of the following values:

- World - global coordinate space.
- Parent - local coordinate system of the parent of the object specified by the Object parameter. Parent object's origin point is used as the center of coordinates, while its angles of rotation define the directions of the coordinate axes.
- Local - local coordinate space of the selected object. Similar to the Parent coordinate space, but in this case, the origin point of the object itself is used as the origin of coordinates.

Set to World by default.

Location How the object will move along the X, Y and Z axes. By default, all three parameters are set to zero. Values can be specified in the node itself or through the variables (if the Variable option is enabled).

Rotation Object's rotation around the X, Y and Z axes. All three values are set to zero by default. Can be specified directly in the node or through the variables (if the Variable option is enabled).

Scale Object's size. Can be specified directly or through a variable (if the Variable parameter is enabled). Set to 1 by default.

Duration Time (in seconds) that the transformation will take. It can be specified both directly or with a variable (to do this, the Variable parameter should be enabled). Set to zero by default.

Move To

Can be used to move objects.

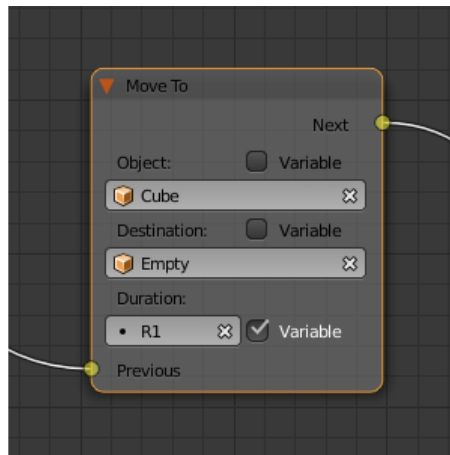

Input Parameters

Previous Previous node.

Output Parameters

Next Next node.

Internal Parameters

Object An object that you need to move. It can be set directly or using an Object-type variable (if the Variable option is enabled)

Destination A target (another object or a light source, camera or anything else) to which the selected object will move. The object's coordinated will be the same as the target's after the movement is finished.

This parameter can be set directly or using an Object-type variable (if the Variable option is enabled).

Duration Time (in seconds) that the object will spend moving to the new location. By default, this parameter is set to zero (and in this case, the object doesn't actually move, it just changes its position in a moment). It can be set manually or with a variable (available only if the Variable parameter is enabled).

Apply Shape Key

Set the Shape Key factor.

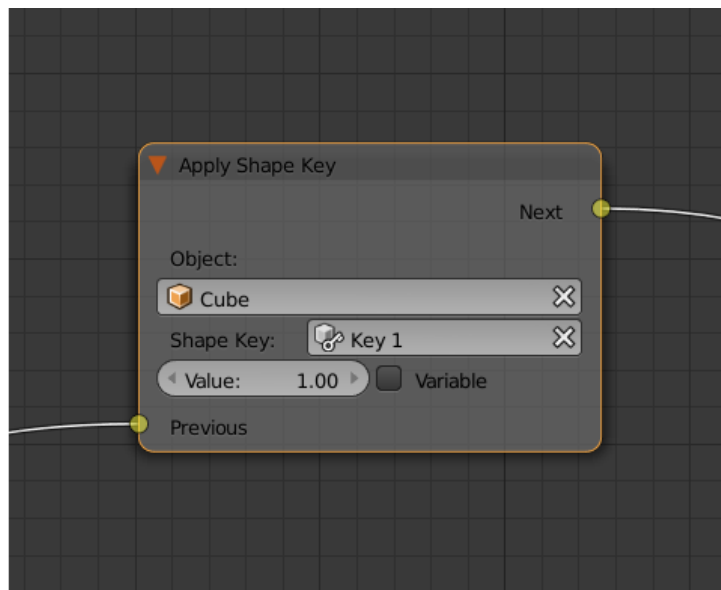

Input Parameters

Previous Previous node.

Output Parameters

Next Next node.

Internal Parameters

Object An object that needs to be transformed.

Shape Key Shape key that will be applied to the object.

Value How much the shape key will influence the object. This value can be set directly in the node or using a variable (if the Variable parameter is set). The value should be between 0 and 1.

Outline

Controls object outlining effect.

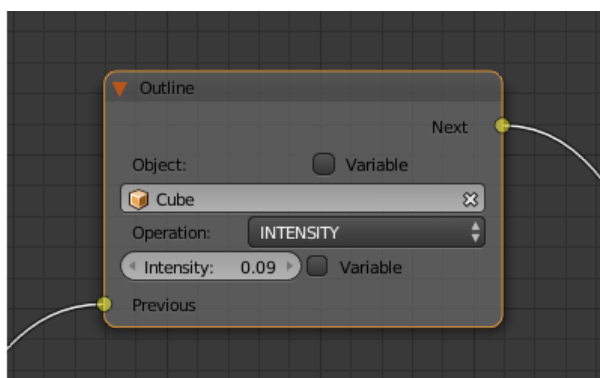

Input Parameters

Previous Previous node.

Output Parameters

Next Next node.

Internal Parameters

Object Any changes of the outline effect will be applied only to an object specified by this parameter.

Variable If this parameter is enabled, an Object-type variable can be set in the Object field.

Operation Specifies an operation that will be done to the object's outline. This parameter can have one of the following values:

- PLAY enables outline animation
- STOP disables it
- INTENSITY can be used to set intensity of the object's outline

Intensity Outline intensity. This parameter is only available if the Operation parameter is set to INTENSITY. The value can be set manually or via variable (if the Variable parameter is enabled).

Set Shader Node Param

Can be used to set the value for the shader node. Currently, only Value and RGB nodes are supported.

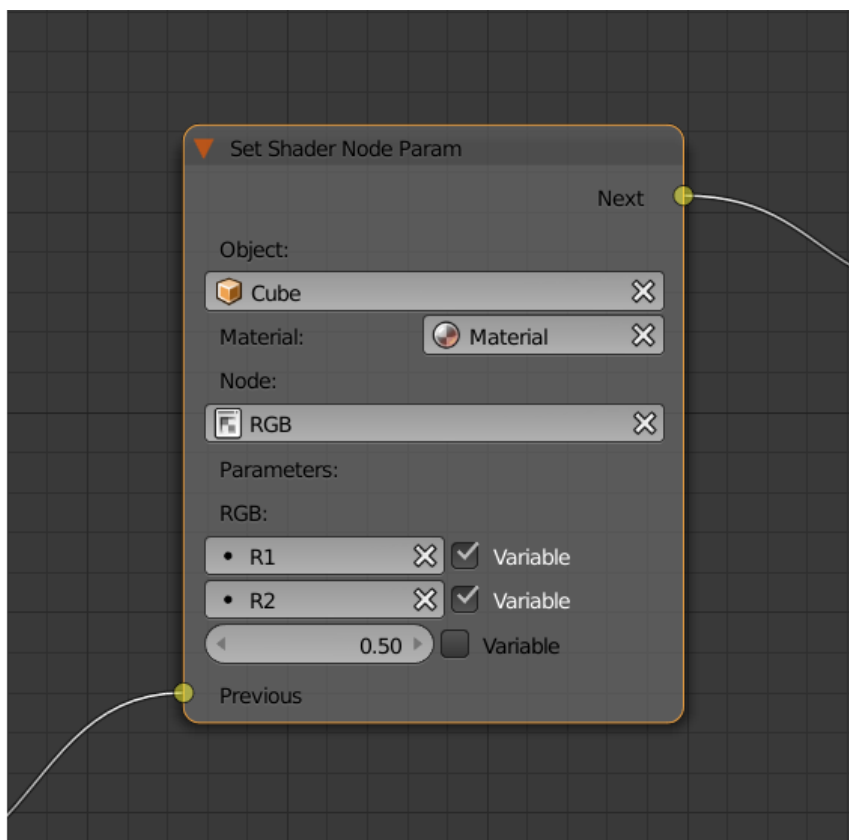

Input Parameters

Previous Previous node.

Output Parameters

Next Next node.

Internal Parameters

Object An object that has material that needs to be edited.

Material Material that needs to be edited. It should use nodes.

Node A node that has parameters that can be changed. For now, only Value and RGB nodes are supported.

Parameters Editable parameters of the selected node. They can be set in the node itself or through the variables (if the Variable parameter is enabled).

Inherit Material

Copy attributes from one material to another.

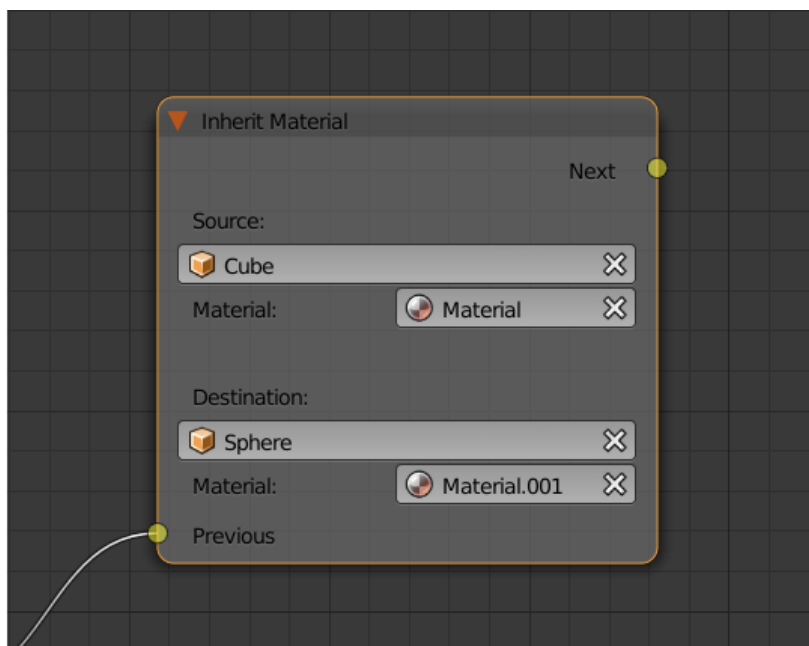

Input Parameters

Previous Previous node.

Output Parameters

Next Next node.

Internal Parameters

Source An object that has a material that will be inherited.

Material The material to inherit.

Destination An object that will inherit selected material.

Material The material that will be replaced by the inherited one.

Operations

Variable Store

Saves numerical or string value to a variable.

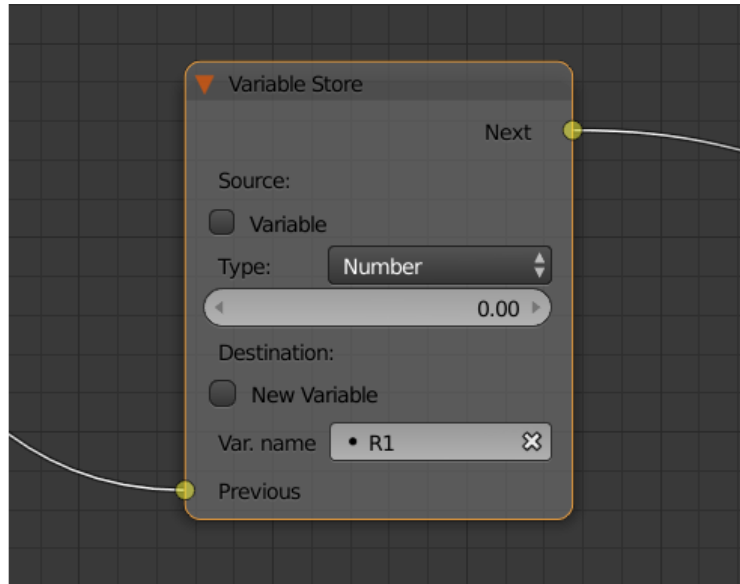

Input Parameters

Previous Previous node.

Output Parameters

Next Next node.

Internal Parameters

Var. name. Name of the variable. Can be selected from the list of variables or specified manually (if the New variable parameter is enabled).

Type Variable's type. This parameter can have one of the three values: Number (for numerical variables), String (for string variables) or Object (for object variables).

Object This parameter is used to specify the object that will be used as a variable. It is only available if the Type parameter is set to Object.

New Variable If this parameter is enabled, you can manually input a variable's name and not just select one of the variables. This can be used to transfer the data between the application and the server.

Global Enabling this parameter makes the variable global. Available only if the New Variable parameter has been enabled.

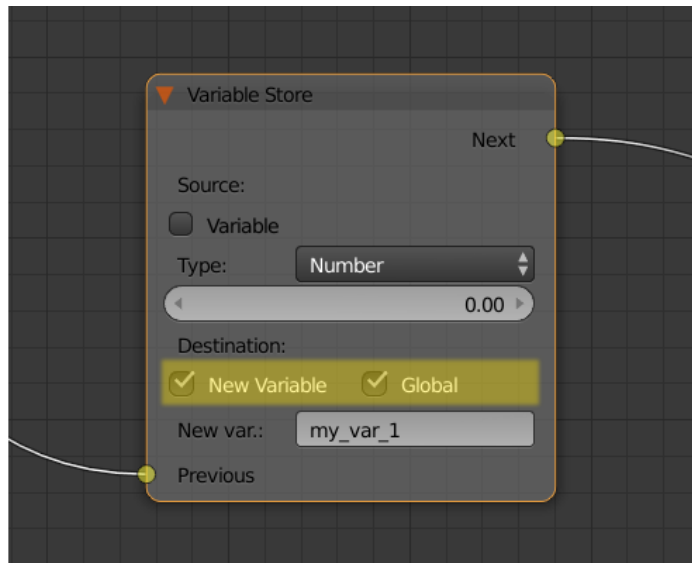

Math Operation

Perform a math operation and store the result in the variables. Any of parameters (operands) can be either a numeric value or a variables.

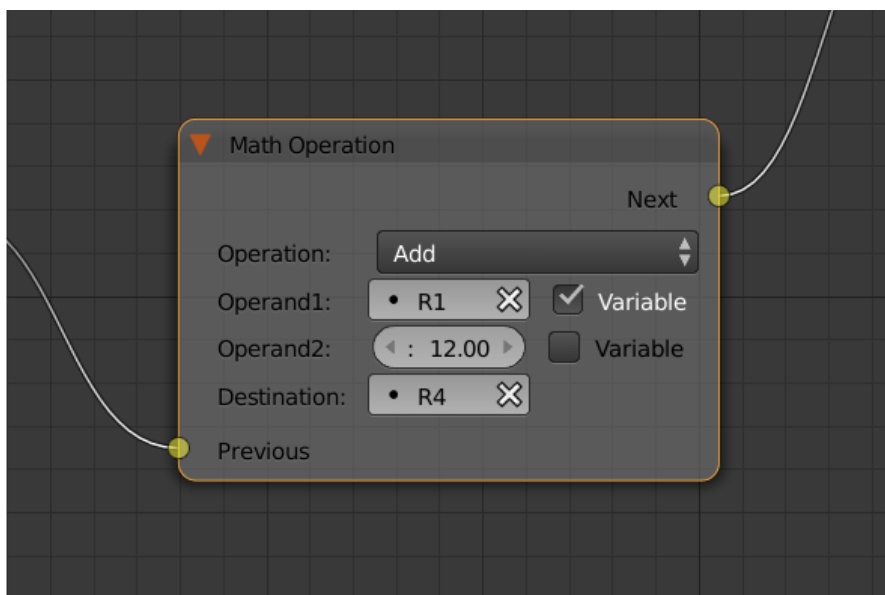

Input Parameters

Previous Previous node.

Output Parameters

Next Next node.

Internal Parameters

Operation Mathematical operation. Can have one of the following types:

- Random generates random value greater than the first operand and less than the second,
- Add sums the operands,
- Multiply multiplies the operands,
- Subtract subtracts the second operand from the first,
- Divide divides first operand by the second,
- Sin returns the sine of an angle (measured in radians) defined by the first operand,
- Cos returns the cosine of an angle (measured in radians) defined by the first operand,
- Tan returns the tangent of an angle (measured in radians) defined by the first operand,
- ArcSin returns the arcsine value of the first operand,
- ArcCos returns the arccosine value of the first operand,
- ArcTan returns the arctangent value of the first operand,
- Log returns the logarithmic value of the first operand with the second operand used as the base,
- Min returns the lesser one of the two operands,
- Max returns the greater one of the two operands,
- Round rounds the first operator,
- Mod returns the remainder after division of the first operand by the second,
- Abs returns the absolute value of the first operand.

Operand1 First operand. It can be specified in the node or it can be a link to one of the variables (if the Variable parameter is enabled).

Operand2 Second operand. Works the same way as the first.

Destination The result of the operation will be saved in the variable specified by this parameter.

String Operation

Can be used to perform an operation with two strings and save the result to a variable.

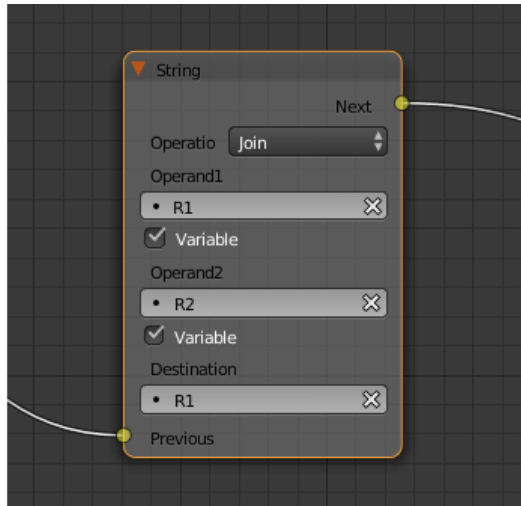

Input Parameters

Previous Previous node.

Output Parameters

Next Next node.

Internal Parameters

Operation An operation that you need to perform with two strings, which can have one of the following values:

- Join - joins two strings into one.
- Find - writes the index of the first occurrence of the second string in the first string to the variable. If there is no occurrences, the value of -1 will be written. It should be noted that the first symbol of a string has an index of 0, not 1.
- Replace replaces first occurrence of the second string in the first string with the third one.
- Split splits the first string in two using the first occurrence of the second string as a splitting mark.
- Compare compares two strings. For this operation, you need to specify a logical condition. If this condition is met, a value of 1 will be outputted to the Destination variable, if it isn't, zero will be outputted.

Condition A logical condition to compare two strings. This parameter is available only if the Operation parameter is set to Compare. Works the same way as the Condition parameter of the Conditional Jump node.

Operand1 The first string. Can be specified in the node itself or with a variable.

Operand2 The second string. Works the same way as the first.

Operand3 This parameter is available only if the Operation parameter is set to Replace. Can be used to specify the third string, which will replace the first occurrence of the second one.

Destination A variable to save the operation's result.

Destination2 This parameter is available only if the Operation parameter is set to Split. Specifies the variable to save the second half of the string that has been split (the first half will be saved to the variable specified by the Destination parameter).

Sound

Play Sound

Can be used to play speaker's sound.

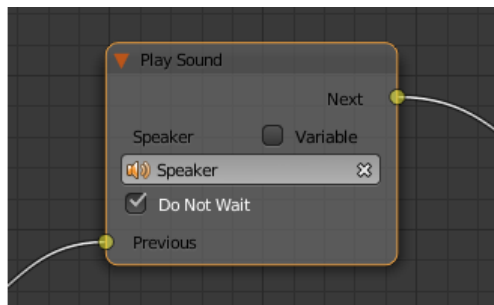

Input Parameters

Previous Previous node.

Output Parameters

Next Next node.

Internal Parameters

Speaker A speaker that will be enabled.

Variable If this parameter is enabled, an Object-type variable can be set in the Speaker field.

Do Not Wait If this parameter is enabled, the control will pass to the next node right after sound playback starts. If it isn't enabled, the control will pass only when the playback is finished.

Stop Sound

Can be used to stop speaker's sound.

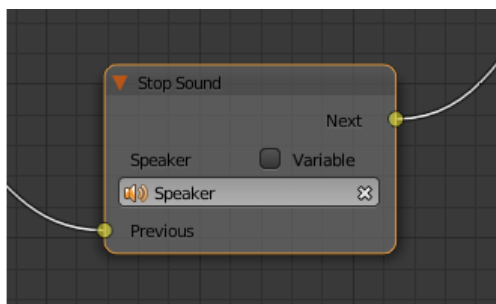

Input Parameters

Previous Previous node.

Output Parameters

Next Next node.

Internal Parameters

Speaker A speaker that will be turned off.

Variable If this parameter is enabled, an Object-type variable can be set in the Speaker field.

Network

Send Request

Send an HTTP GET request to the specified URL and save the respond's fields a variable.

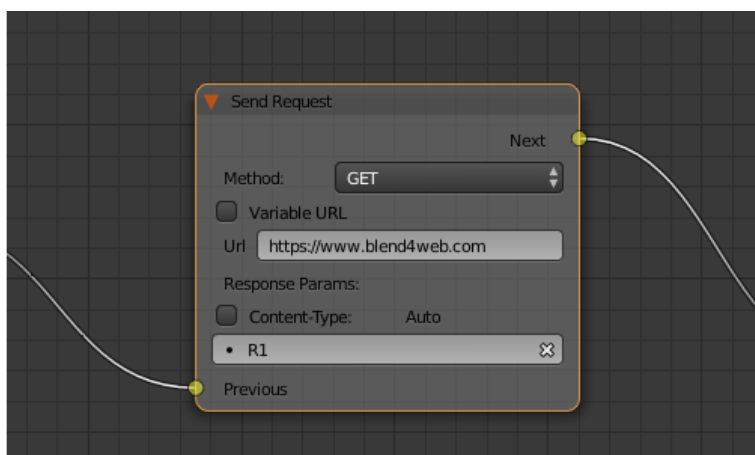

Input Parameters

Previous Previous node.

Output Parameters

Next Next node.

Internal Parameters

Method Method of the request. Can have one of two values:

- GET is used to request data from the server.
- POST is used to send data to the server.

Set to GET by default.

Url A web address to send request to. It can be defined directly or using a variable (if the Variable URL option is enabled). Set to “<https://www.blend4web.com>” by default.

Response Params Specifies the variable to save the data received from the server.

Note: The data received from the server should be in the JSON format:

```
{
  "var0": 1,
  "var1": 10,
  "var2": 144
}
```

Content-Type Indicates the media type of the message content. Consists of a type and a subtype, for example: text/plain. Set to Auto by default. Can be used to reassign the title of the HTTP request.

Request Params Specifies the variable that contains a JSON object that will be sent to the server. Available only if the Method parameter is set to POST. Default value is R1.

JSON

This node can be used to encode and decode complex JSON objects.

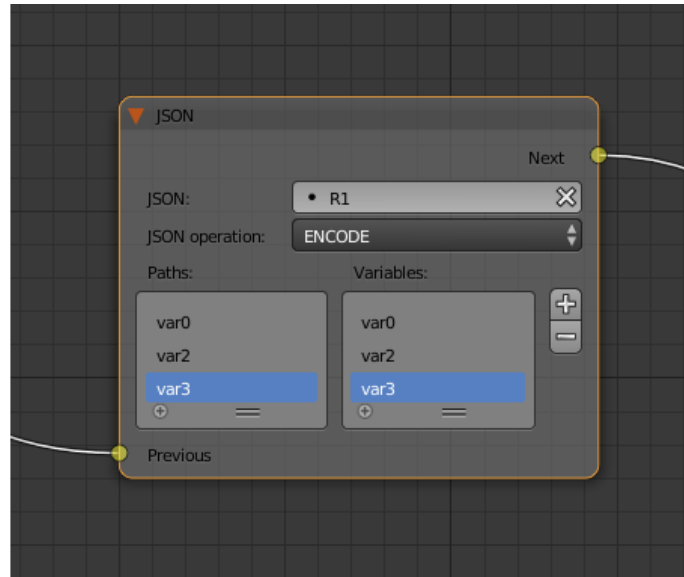

Input Parameters

Previous Previous node.

Output Parameters

Next Next node.

Internal Parameters

JSON A link to a JSON object that you need to decode or encode. Set to R1 by default.

JSON Operation An operation you need to perform with the JSON object specified by the JSON parameter. Can have one of two values: ENCODE to encode the JSON object and PARSE to decode it. Set to ENCODE by default.

Paths A list of paths to the variables inside the JSON object. Paths are used to define the inner structure of a JSON object. A path should consist of several identifiers (separated by dots) that serve as a path to a JSON field. If a name of a fragment of the path consists solely of numbers, this name is interpreted as an array index. Paths are created and deleted in conjunction with variables (in the Variables list), and one path always corresponds to one variable. This list can be used both to encode and to decode JSON object. By default, the list is empty.

Variables A list of variables that will be used to either store the decoded data or to encode a JSON object (depending on the value of the JSON Operation parameter). The names and the quantity of the variables can be adjusted manually. This list is also empty by default.

Using JSON logic node to encode JSON object

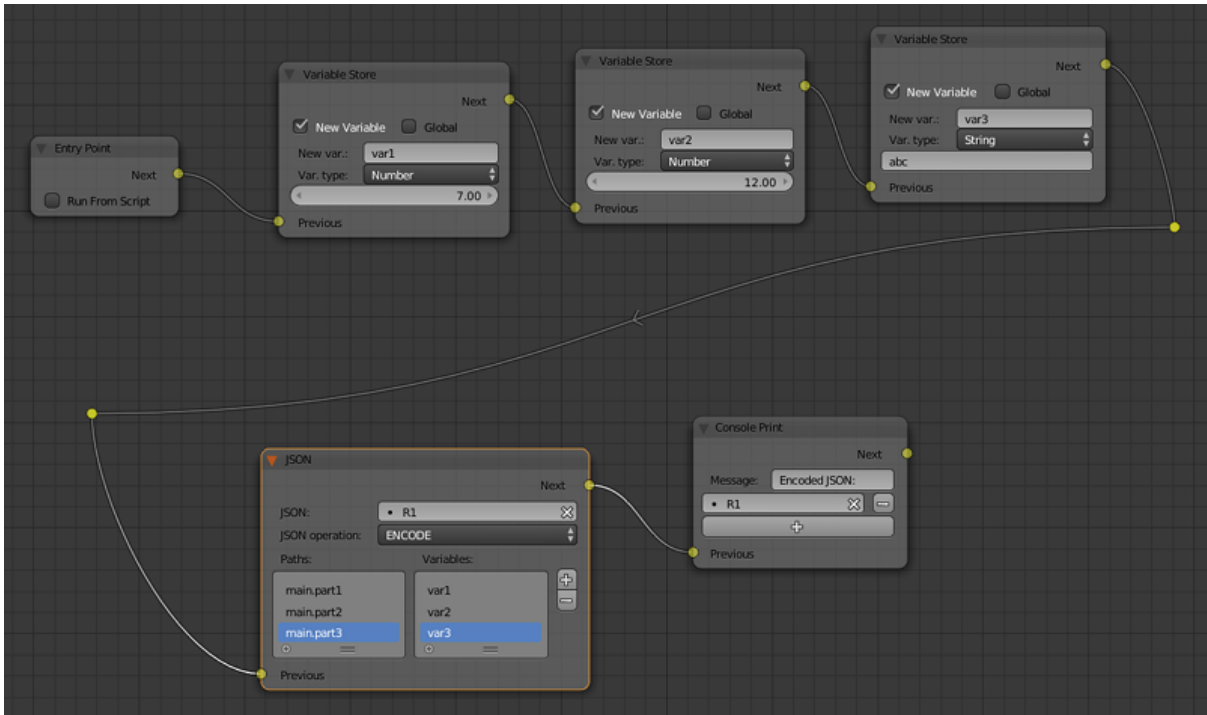

The logic node setup at the picture above encodes a JSON object and stores it in the R1 variable. Such a JSON object looks like this:

```
{
  "main":{
    "part1":7,
    "part2":12,
    "part3":"abc"
  }
}
```

Using JSON logic node to decode JSON object

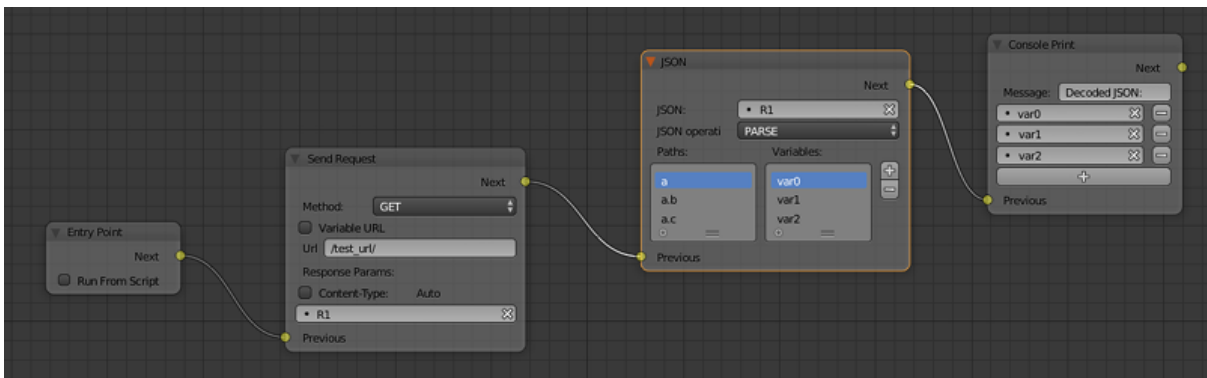

The picture above shows a logic node setup that receives a JSON object from the server, stores it in the R1 variable and then decodes it. Such a JSON object looks like this:

```
{
  "a": {
    "b": 17,
    "c": "abc"
  }
}
```

Decoding this JSON object with the JSON logic node results in three variables named var0, var1 and var2 (you don't have to create the variables beforehand) that will contain various parts of the JSON object. In this example, the var1 variable has the value of 17, the var2 variable has the value "abc", while the var0 variable contains the following fragment of the JSON object:

```
{
  "b": 17,
  "c": "abc"
}
```

Page Param

Allows to store any web page parameter in a given variable.

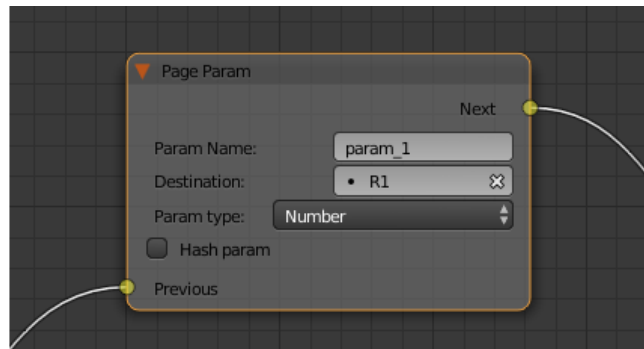

Input Parameters

Previous Previous node.

Output Parameters

Next Next node.

Internal Parameters

Param Name The name of the web page parameter.

If the parameter specified in this field is presented in the URL, then its value will be saved to a variable specified by the Destination parameter.

Destination A variable that will be used to save the parameter.

Param type The type of the web page parameter. Available values are Number, String and Object.

Hash param If this option is enabled, the Page Param node will process hash parameters; if it isn't, the node will process regular URL parameters.

Page Redirect

Can be used to redirect the browser to another page. This node always marks the end of the node tree and doesn't have any output parameters.

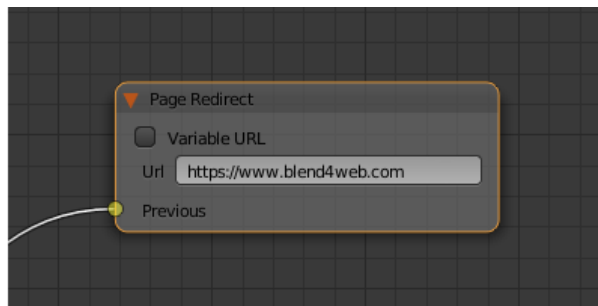

Input Parameters

Previous Previous node.

Output Parameters

None.

Internal Parameters

Url Web address of a page that will be opened. It can be defined manually or using a variable (if the Variable URL parameter is enabled). Set to “https://www.blend4web.com” by default.

Time

Date & Time

This node returns the current time and date.

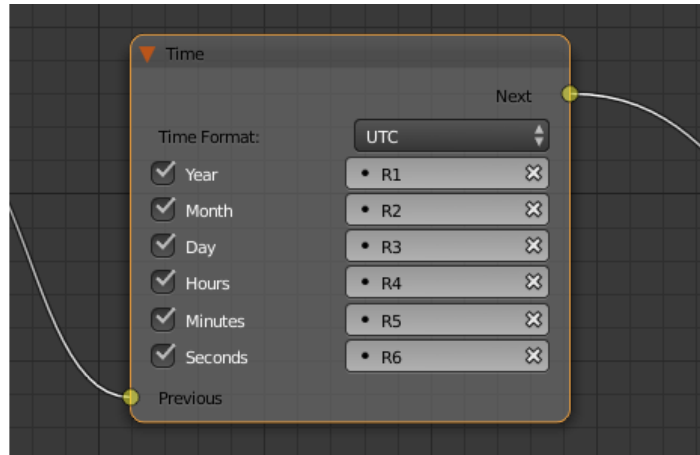

Input Parameters

Previous Previous node.

Output Parameters

Next Next node.

Internal Parameters

Time Format This parameter defines the format in which time is measured. It can be set to one of the following values:

UTC Coordinated Universal Time.

Note: The Coordinated Universal Time this node returns is based on local system time and a time zone.

Local If this value is selected, time is retrieved from local system time. This value is selected by default.

The time and date are returned as a set of numbers (current year, month, day etc.), each one of which can be stored into a specific variable. These numbers include:

Year The current year.

Month The current month.

Day The current day.

Hours The current hour.

Minutes The current minutes.

Seconds The current seconds.

Get Timeline

This node can be used to get the current frame of an NLA animation or a timeline.

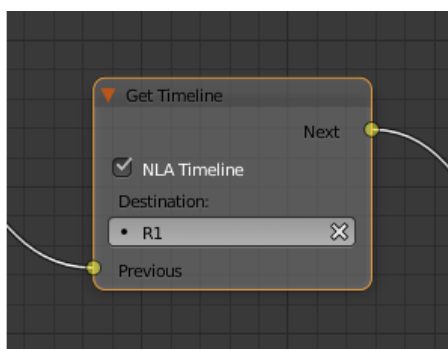

Input Parameters

Previous Previous node.

Output Parameters

Next Next node.

Internal Parameters

NLA Timeline If this parameter is enabled, the node will return the current frame of an NLA animation. If it is disabled, the node will return the current frame of the timeline. Enabled by default.

Destination Specifies a variable to store the number of the current frame. Set to R1 by default.

Elapsed

This node returns the amount of time elapsed since the previous frame has been rendered.

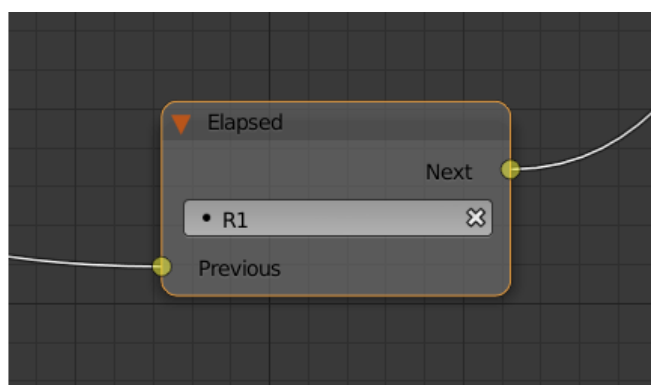

Input Parameters

Previous Previous node.

Output Parameters

Next Next node.

Internal Parameters

The Elapsed logic node has one internal parameter that allows user to specify the variable to save the number of seconds passed since the previous frame. By default, it uses the R1 variable.

Delay

Make a delay (measured in seconds) before going to the next node.

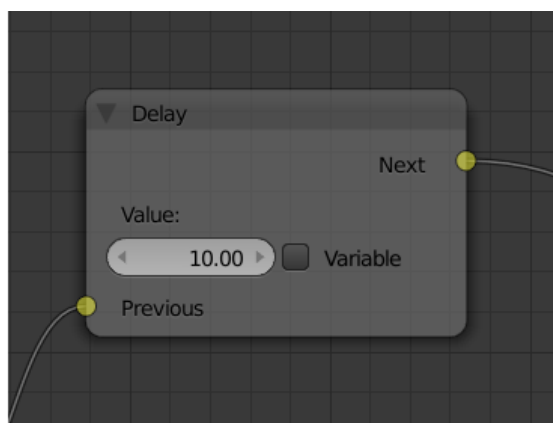

Input Parameters

Previous Previous node.

Output Parameters

Next Next node.

Internal Parameters

Value Time (in seconds) that will pass before the activation of the next node. Set to zero by default. Can be set manually or through a variable (if the Variable parameter is enabled).

Layout

Frame

An auxillary element used to separate nodes into groups.

Tip: This is not required, but we recommend to use frames in complex node setups so it would be easier to read and understand them.

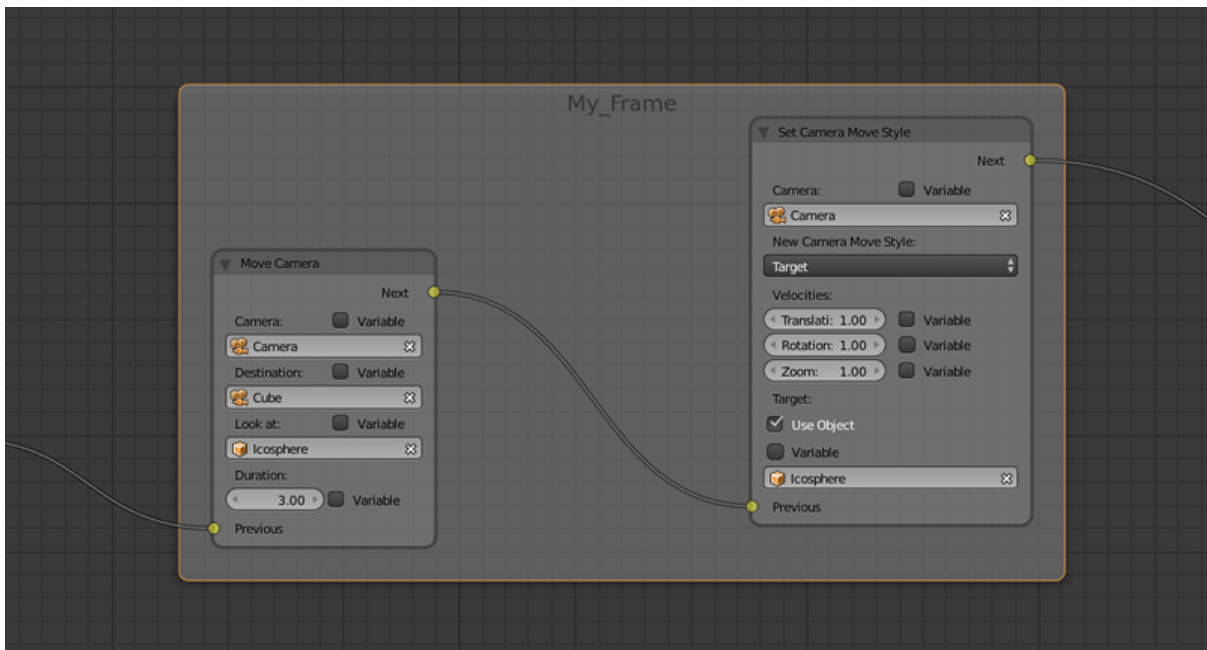

Frame elements feature several parameters that can be accessed from the Properties side panel. These parameters include Label (can be used to set a title for the frame) and Color (defines the color of the frame).

This element is also available in regular Blender node editors.

Empty

This is a simple pass-through node that does not perform any operations on its own. It can be used to combine several logic threads into one or simply to make the logic node setup easier to read and understand.

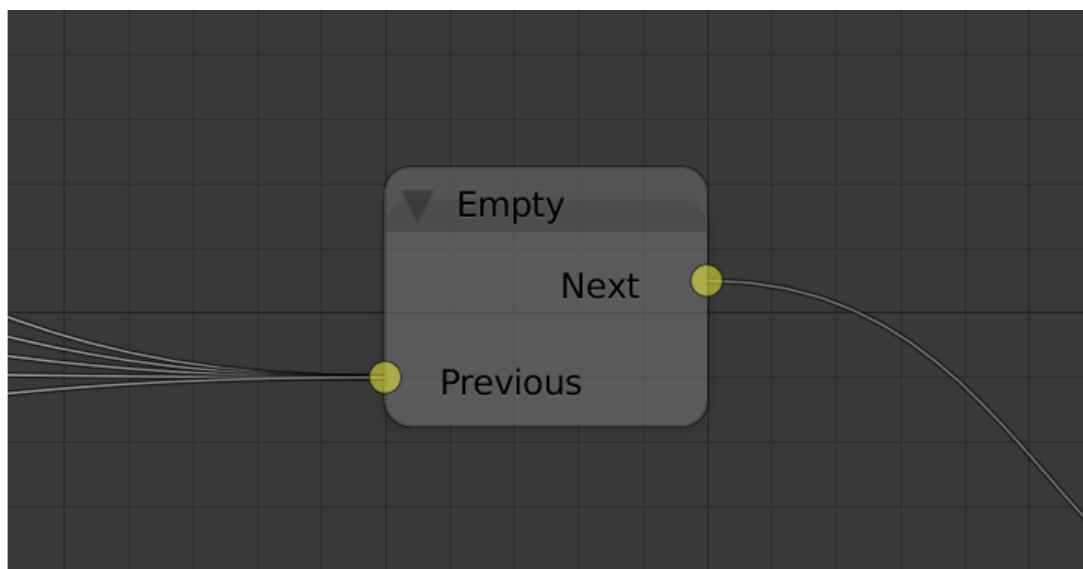

Input Parameters

Previous Previous node (or several nodes).

Output Parameters

Next Next node.

Internal Parameters

None.

Reroute

Logic Editor also has Reroute elements, the nodes that don't do anything aside from passing the control to the next node or to the next Reroute element. Such elements can be used to create cyclic structures or to make the node tree easier to read and understand.

Unlike the Empty node, Reroute element can only handle a single logic thread.

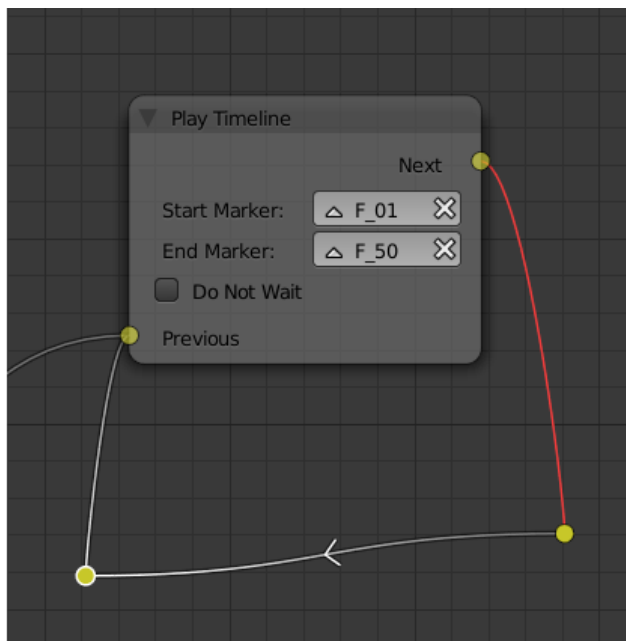

Note: Output parameter can't be connected to the same node's input parameter. If you need to do this (to make a cycle, for example), you should use Reroute elements.

Debug

Console Print

This node prints variables's values and additional text to the web browser console. It can be used for debug purposes.

```

    ▲ Use of getPreventDefault() is deprecated. Use defaultPrevented instead.
    B4W LOG: THREAD 0: LOADED CALLBACK
    B4W LOG: START NLA
    B4W LOG: That's how it looks: {"R2":0,"R1":10}
  
```

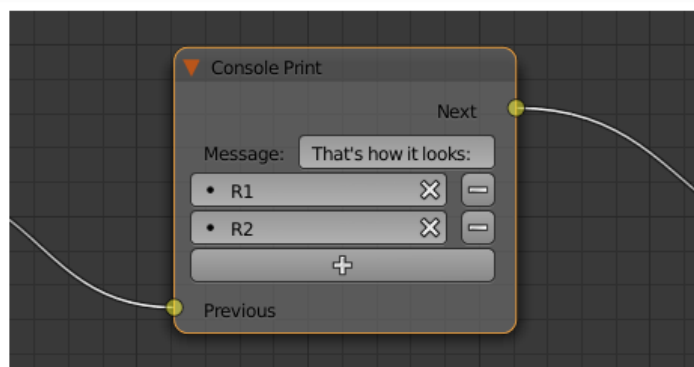

Input Parameters

Previous Previous node.

Output Parameters

Next Next node.

Internal Parameters

Message A message that will be printed to the console along with the values.

<variable name> A variable that will be printed to the console. By default, a Console Print node has one such parameter, but you can add new and delete existing ones (the node might not even have such parameters at all).

Other Features

For debugging purposes some nodes inside logic tree can be muted. To do that select the required node and press the M key. Muted nodes are not evaluated and simply pass control to the next ones. If the muted node has two outputs the execution continues from the output with negative result (Miss, False).

Lighting, Shadows and Background

Table of Contents

- Lighting, Shadows and Background
 - Shading Types
 - Lighting with Light Sources
 - * Light source types
 - * Light source setup
 - Environment Lighting (Ambient)
 - * Activation
 - * Setup
 - * Environment map method
 - Shadows
 - * Activation
 - * Setup
 - Background

Shading Types

Lighting (shading) depends on the direction of normal vectors. The standard Blender's shading types are supported: Shading: Flat (face normals are used), Shading: Smooth (interpolated vertex normals are used) and their combinations.

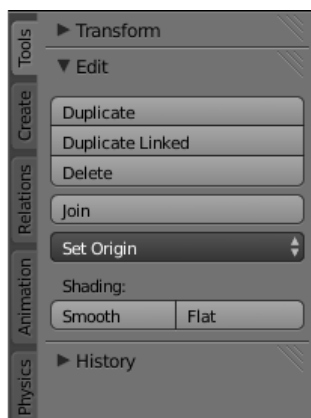

If the required effect is impossible to achieve with the standard tools, you can use the normals editor.

The result of applying different shading types and using the normals editor:

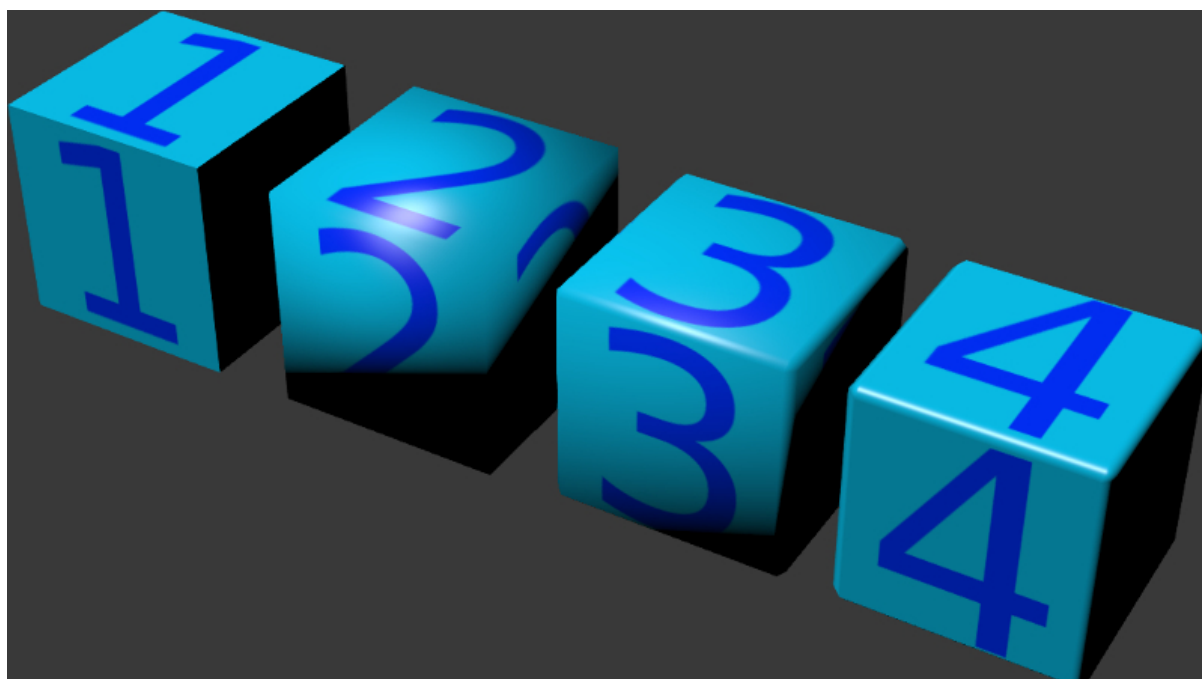

1. Flat Shading
2. Smooth Shading
3. Smooth Shading + bevel
4. Smooth Shading + bevel + editing normals

Lighting with Light Sources

A scene can have multiple (but not less than one) light sources of different types.

Light source types

The following light source types are supported:

Point Light propagates from one point uniformly to all directions with gradual attenuation.

Sun Light propagates from an infinite plane in one direction without attenuation.

Spot Light propagates from one point within the angular limit, with gradual attenuation.

Hemi Hemispherical. Light propagates from an infinite hemisphere without attenuation.

Light source setup

Performed in the Object Data tab when a lamp object is selected.

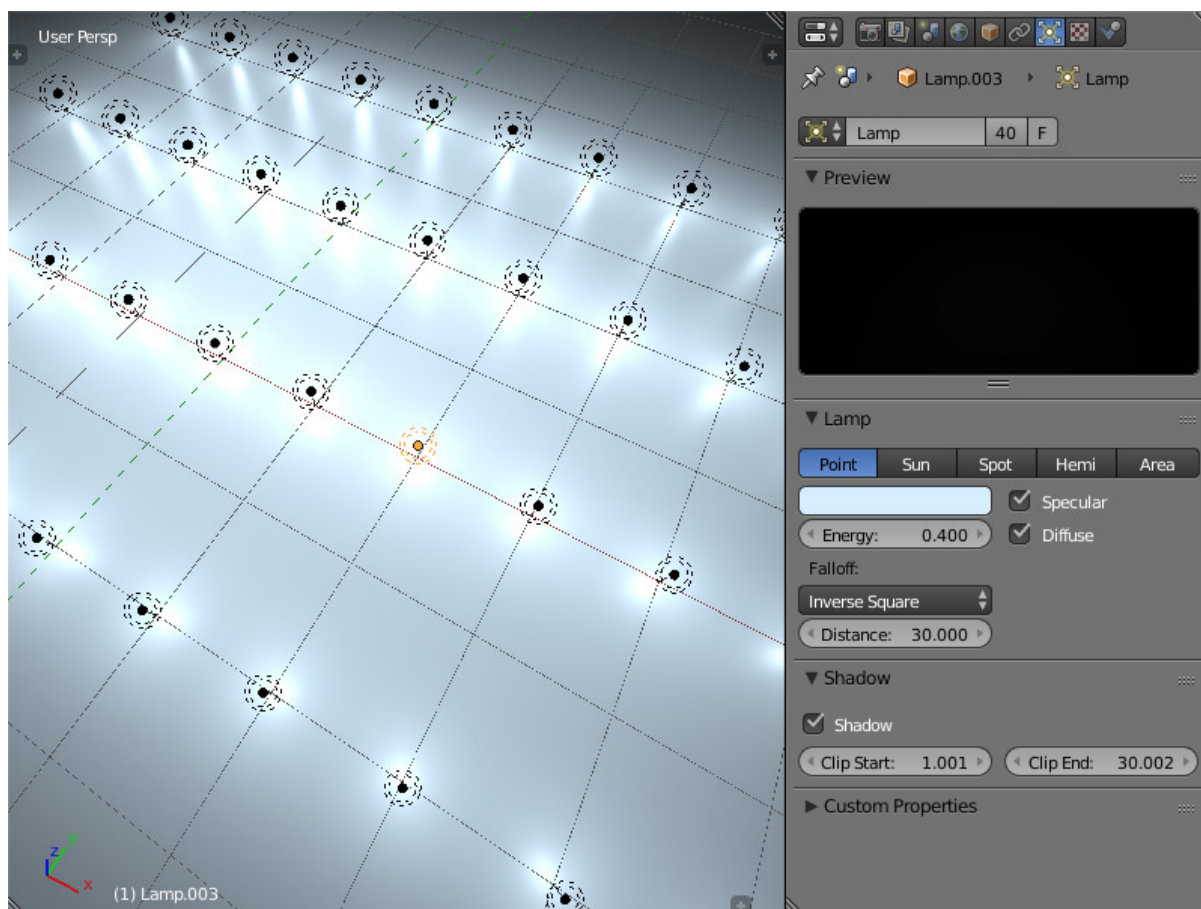

Color Light color. The default value is (1.0, 1.0, 1.0) (i.e. white).

Energy Radiation intensity. The default value is 1.0.

Falloff Attenuation type. The value is exported but the engine always uses Inverse Square. It is applicable to the Point and Spot light source types. The default value is Inverse Square.

Distance Attenuation parameter. It is applicable to the Point and Spot light source types. The default value is 30.0.

Specular Create specular highlights. Enabled by default.

Diffuse Do diffuse shading. Enabled by default.

Spot Shape > Size Cone angle in degrees. It is applicable to the Spot light source type. The default value is 45°.

Spot Shape > Blend Parameter for blurring light spot edges. It is applicable to the Spot light source type. The default value is 0.15.

Dynamic Intensity Use this light source for calculating the time of day. Applicable only to the Sun light source type. Disabled by default.

Shadow > Shadow Use this light source for shadow calculation. Should be used when multiple light sources are present. Disabled by default.

Shadow > Clip Start This parameter specifies a distance from the light source, below which objects do not generate shadows. Default value is 1.001.

Shadow > Clip End This parameter specifies a distance from the light source, beyond which objects do not generate shadows. Default value is 30.002.

Environment Lighting (Ambient)

The engine supports 3 methods of the environment lighting simulation.

1. Flat white lighting.
2. Hemispherical lighting model in which horizon and zenith colors should be specified. As a result objects are filled with a gradient between these two colors depending on the direction of normals.
3. Lighting using an [environment map](#) - so called image-based lighting.

Please note that environment lighting uses a simplified model which doesn't take into account mutual shadowing of objects.

Activation

Enable the Environment Lighting checkbox on the World tab.

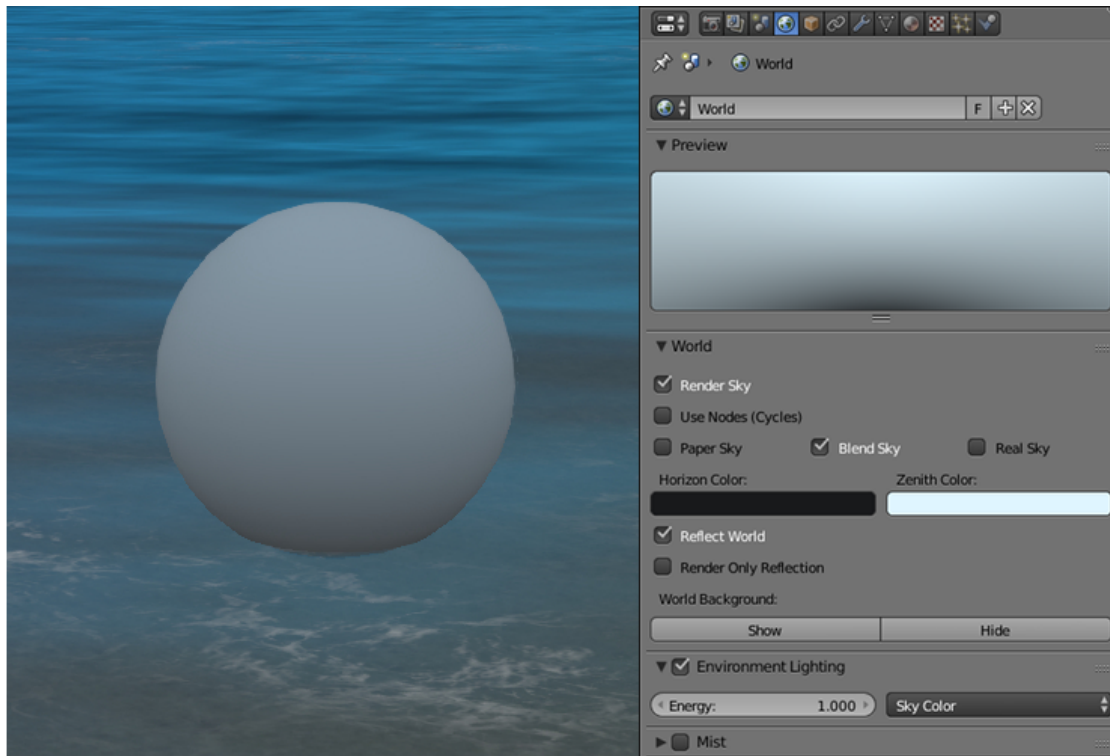

Setup

World > Environment Lighting > Energy Environment lighting intensity. The default value is 1.0.

World > Environment Lighting > Environment Color Selection of the environment lighting simulation method: White - flat white lighting, Sky Color - hemispherical model, Sky Texture - lighting using an [environment map](#). The default value is White.

World > Horizon Color and World > Zenith Color If the hemispherical model (Sky Color) is selected the horizon and zenith colors can be specified by means of the World > Horizon Color and World > Zenith Color color pickers. It is recommended to activate the World > Blend Sky option for better color selection.

World > Use Nodes (Cycles) If this option is enabled, Cycles nodes can be used to set up the environment. Disabled by default.

World > Reflect World If this parameter is enabled, environment will also be rendered for reflections (i.e., it will be reflected by mirror surfaces). Disabled by default.

World > Render Only Reflection If this parameter is enabled, environment will be rendered for reflections, but not for the scene itself. Disabled by default.

Environment map method

To use an environment map for environment lighting:

1. Enable the Environment Lighting checkbox on the World tab.

2. Select Environment Lighting > Sky Texture.
3. Go from the World tab to the Texture tab.
4. Create an **environment map**, load the corresponding image to it.
5. For the environment map select ENVIRONMENT_LIGHTING or BOTH as the Sky Texture Usage value on the Export Options panel (the BOTH option also enables using this texture as a skydome texture).

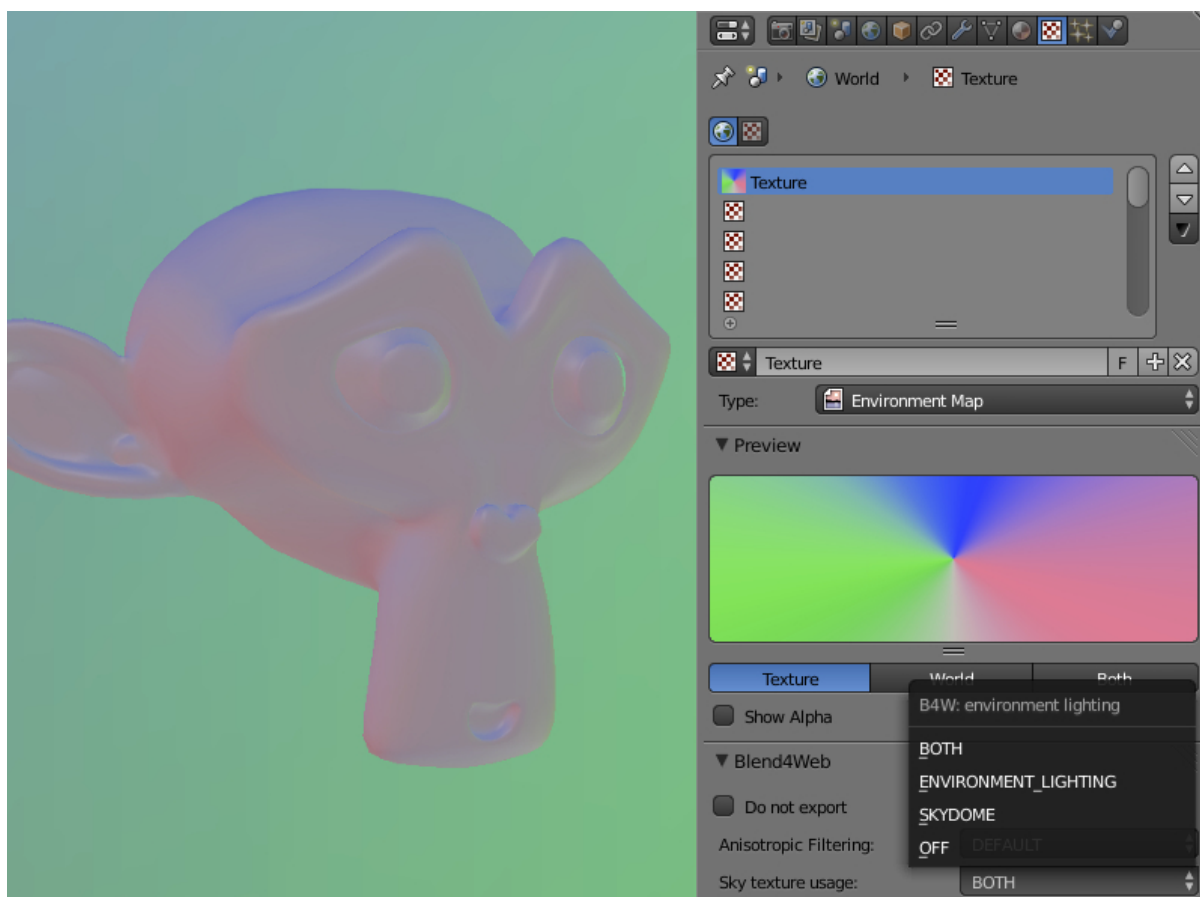

Shadows

Shadows are exceptionally important for rendering the final picture. They provide the viewer not only with information about the objects' outline but also about their height and relative position, light source position and so on.

Blend4Web implements the following shadow rendering techniques: cascaded shadow maps (CSM) and softened shadows (PCF).

Up to 4 (or 3 if SSAO is enabled) light sources can generate shadows simultaneously. If Shadow parameter is enabled for more than 4 light sources, shadows will still be generated only from 4 of them.

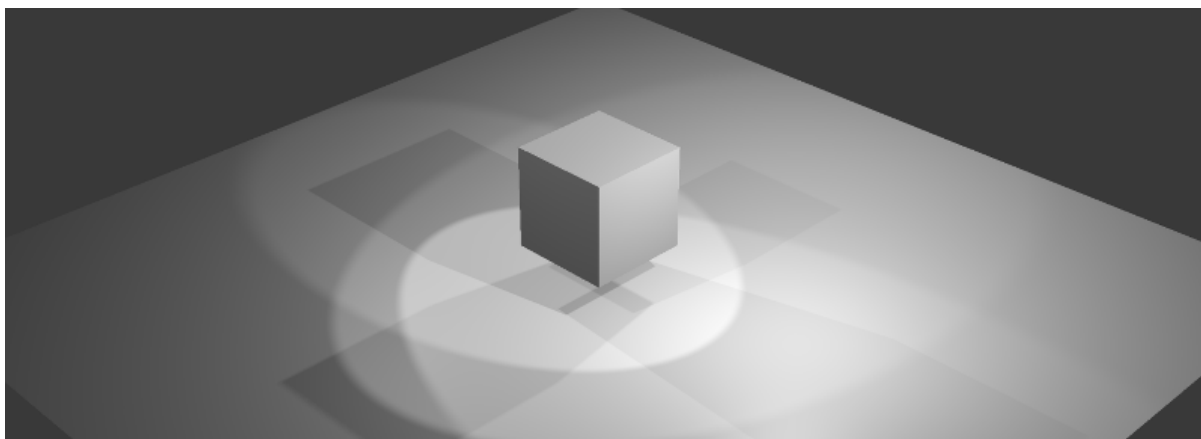

Activation

1. Enable the Shadows: Cast checkbox under the Object tab for the objects which cast shadows.
2. Enable the Shadows: Receive checkbox under the Object tab for the objects which receive shadows.
3. Make sure that the Shadows option in the Render tab has the value AUTO or ON.

Note: Objects, which have [transparent materials with a gradient](#), do not cast shadows.

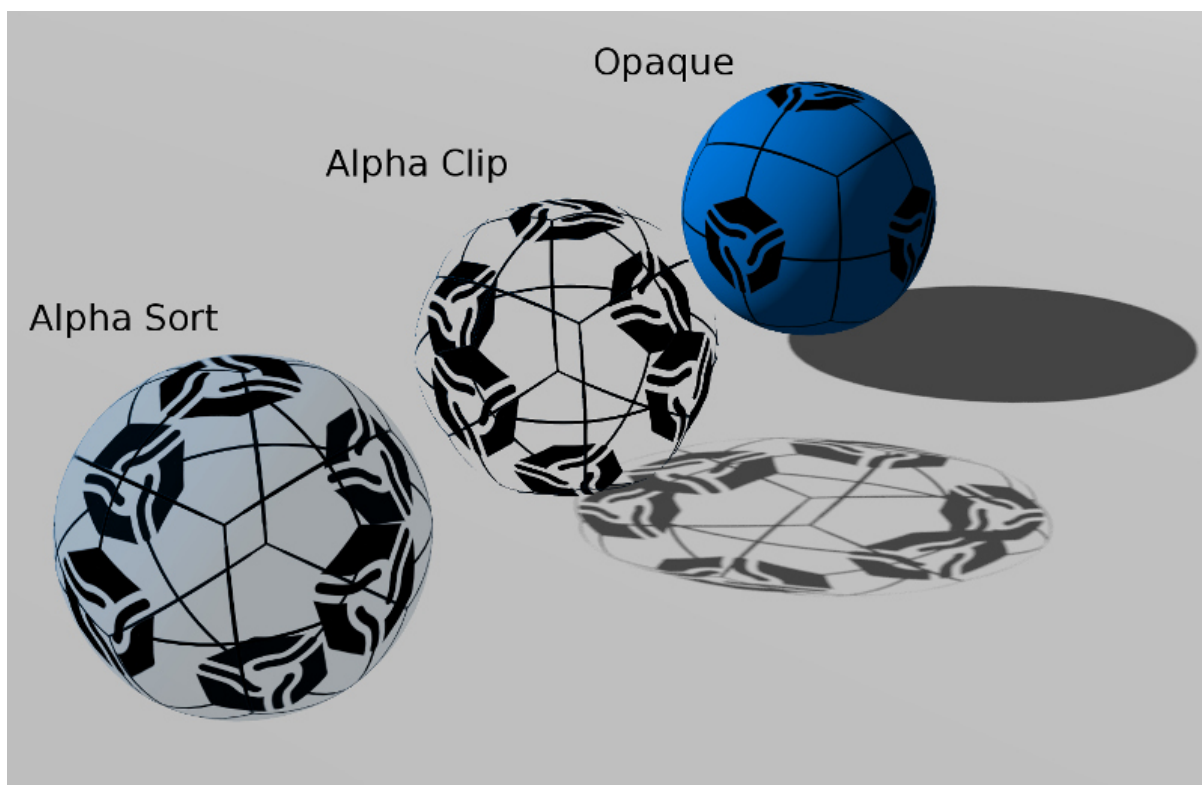

Setup

Direction If there are multiple light sources, it is recommended to specify the exact light source which is used for shadow calculations, by enabling the Shadow > Shadow checkbox under the Object Data tab for the selected lamp object.

Color The shadow color is determined by the [environment lighting](#) settings.

The following additional settings are located on the Shadows panel of the Render tab:

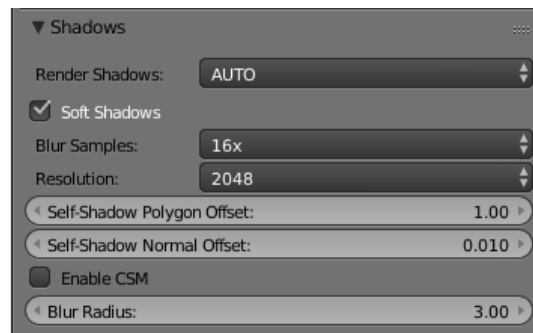

Render Shadows Enables and disables shadow rendering. Can be set to ON, OFF and AUTO. Set to AUTO by default.

Soft Shadows This option enables smoothing of the shadow maps. Enabled by default.

Resolution Shadow map resolution. The default value is 2048 x 2048px.

Blur Samples The number of the samples used for smoothing shadow maps. Available values are 4x, 8x and 16x, with the latter being the default value.

Self-Shadow Polygon Offset Coefficient for shifting polygons relative to light source orientation. The default value is 1.

Self-Shadow Normal Offset Coefficient for shifting polygons along their normals. The default value is 0.010.

The last two parameters can be used to reduce self-shadowing artifacts. These artifacts appear for the objects that cast and receive shadows at the same time. The Self-Shadow Polygon Offset parameter is more effective for fighting against artifacts in inner areas of polygons while Self-Shadow Normal Offset is better for the boundary areas. Both these parameters lead to shadow distortions so we recommend to set them as low as possible.



Note: Shadows from Point light sources are generated the same way as from Spot light sources and are projected only in one direction specified by the source's Rotation parameter.

Enable CSM Activates the using of cascaded shadows model; reveals additional options. Disabled by default. Won't work if the Shadow setting is enabled for more than one light source. Point and Spot type light sources support only one shadow cascade.

This option allows to choose between the following shadow generation models:

- Generic model which uses a single optimized shadow map for the whole scene (Enable CSM is turned off).
- Shadow cascades (Enable CSM is turned on).

Blur Radius Blur ratio for setting up softened shadows. The default value is 3. Zero value produces hard shadows.

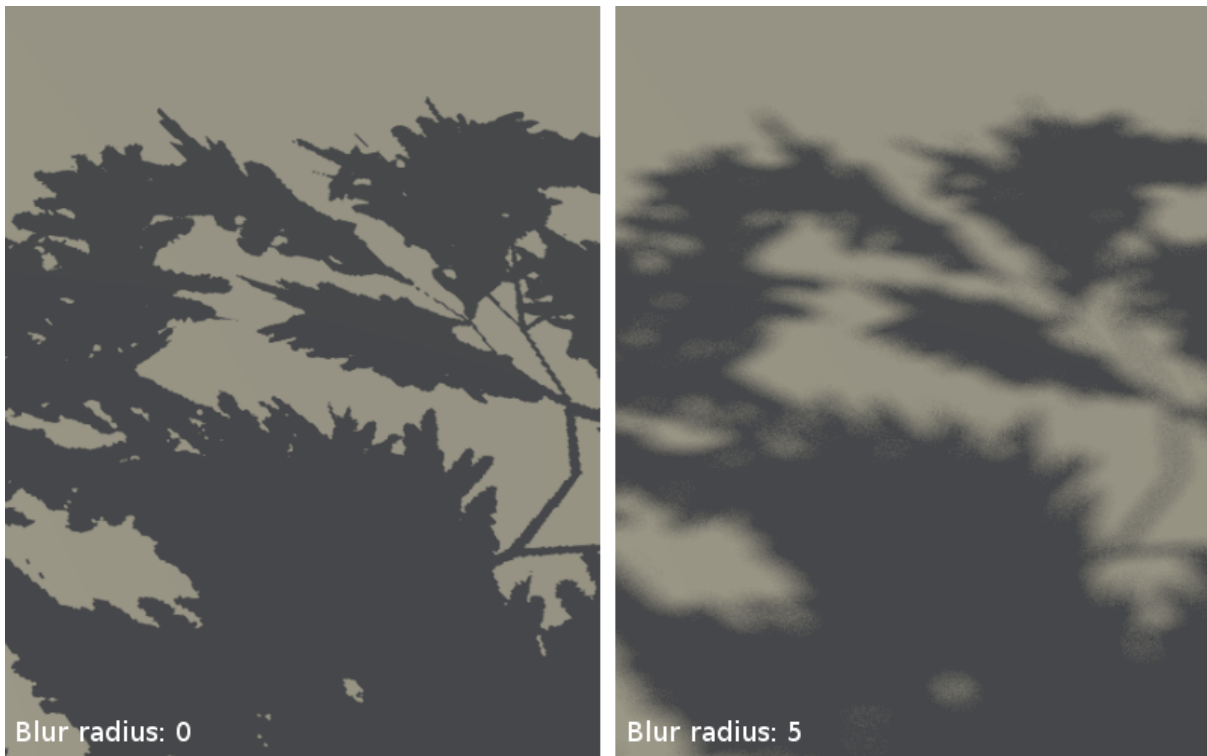

Softened shadows can improve visual quality and realism. They hide the jugged edges inevitable when using image-based techniques, that is especially noticeable for low-resolution shadow maps. The using of softened shadows often allows to decrease resolution without substantial quality loss.

Generic shadows

This option suits well smaller scenes with a limited number of objects. Thanks to optimizations applied for such scenes, one can achieve better shadow quality as compared with cascaded shadows. Also, this option is simpler and faster for setting up, while using a single shadow map greatly improves the performance.

Shadow cascades

Note: These settings are supported only for Sun light sources. Cascades are turned off for other types of light sources.

In order to provide acceptable shadow quality and to cover considerable space at the same time it is required to use multiple stages for shadow generation (cascades). Thus, the best quality cascades are situated near the observer while the worst quality cascades are in the distance. This option suits well middle-to-large scenes, e.g. game levels.

When enabled the following extended settings are revealed:

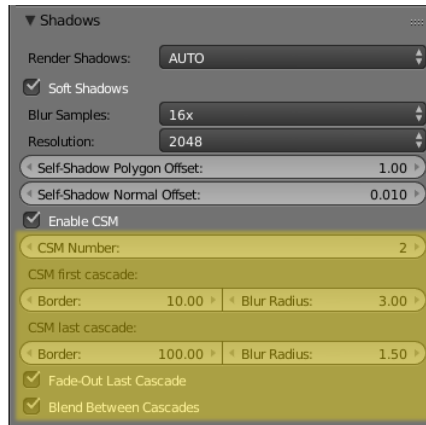

CSM Number Number of shadow cascades. From 1 to 4 cascades are supported. The default value is 1.

CSM First Cascade Border First cascade size. The default value is 10.0.

CSM Last Cascade Border Last cascade size. The default value is 100.0.

The sizes of the intermediate cascades are interpolated between the two above-mentioned parameters.

Note: When setting up the shadows keep in mind that the bigger the cascade size is, the worse and less detailed are the shadows inside it. On the other hand, reducing the CSM First Cascade Border parameter makes the subsequent less detailed cascades closer to the camera and thus more noticeable. Reducing the CSM Last Cascade Border parameter forces shadows to disappear at more close distance from the camera. However, when softened shadows are used the overall quality will improve thanks to blurring at the edges.

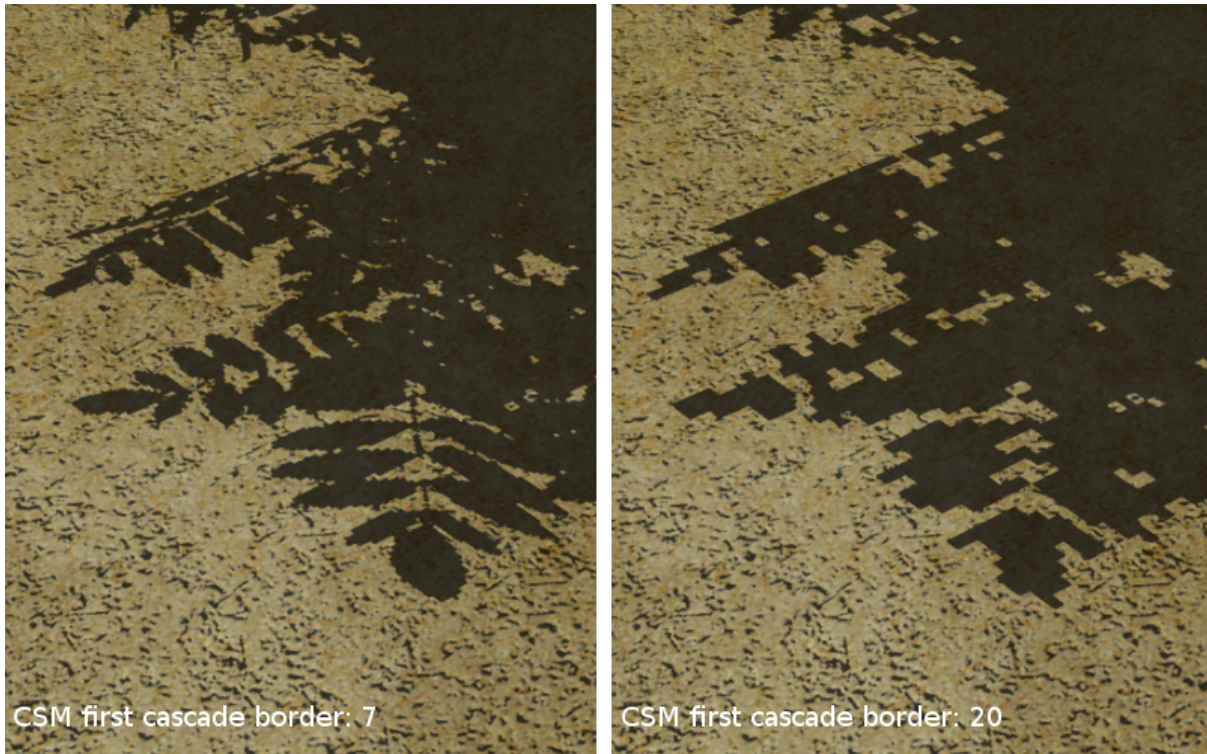

CSM First Cascade Blur Radius Blur ratio for the first cascade. The default value is 3. Zero value produces hard shadows.

CSM Last Cascade Blur Radius Blur ratio for the last cascade. The default value is 1.5. Zero value produces hard shadows.

The blur radii of the intermediate cascades are interpolated between the two above-mentioned parameters.

Note: We recommend to start setting up the softened shadows with the first cascade (using CSM First Cascade Blur Radius) and then proceed to other cascades (using CSM Last Cascade Blur Radius). Often the last cascade may need less blurring than the first one. This may be needed to prevent the shadows on the last cascade being too faded due to low resolution. This also reduces undesirable self-shadowing artifacts.

Fade-out Last Cascade Smooth dying-out of the last cascade. Enabled by default.

Blend Between Cascades Smoothing the boundaries between the cascades. Enabled by default.



Background

You can change the background in the following ways:

1. Enable World > Render Sky, then set the Horizon Color and the Zenith Color under Blender's World tab.
2. Place the whole scene inside a model (e.g. a cube or a sphere) with its normals directed inside, with a material and an optional texture.
3. Place a surface with a material and an optional texture in front of the camera. Parent it to the camera. If required, tweak the distance to this surface, starting and ending clipping planes for the camera.

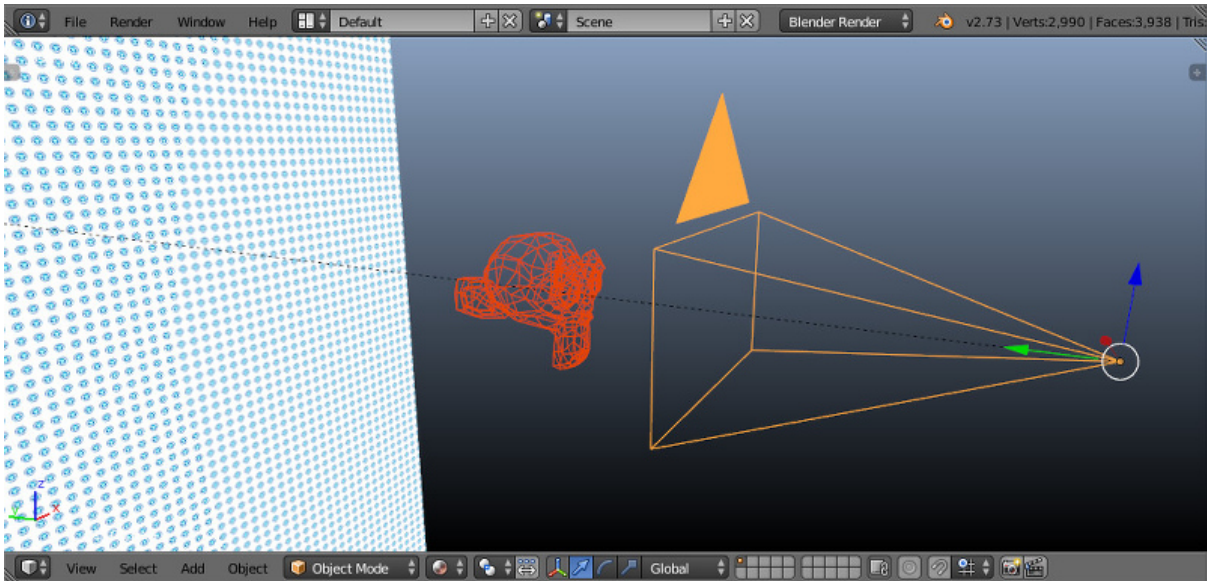

4. Use a skydome.
5. Set up the procedurally generated `atmosphere`.
6. Set the engine's `background_color` parameter with the `config.set()` method. Please note, that `World > Render Sky` under Blender's `World` tab must be disabled. This value is used as argument for the `WebGL clearColor()` method. For correct results, it's recommended to turn the `WebGL context transparency` off (the `alpha` parameter). Such the configuration is used by default in the engine's standard web player.

```
var m_cfg = b4w.require("config");
var m_main = b4w.require("main");

// gray
m_cfg.set("background_color", new Float32Array([0.224, 0.224, 0.224, 1.0]));
m_cfg.set("alpha", false);

m_main.init(...);
```

7. You can use any HTML content behind the canvas element, to which the rendering is performed, as a background. To do this, activate the `WebGL context transparency` (the `alpha` parameter). Please note, that `World > Render Sky` under Blender's `World` tab must be disabled. For correct results, it's recommended to set absolutely transparent black background color. Such the configuration is used by default in the `scene viewer` of `Blend4Web SDK`.

```
var m_cfg = b4w.require("config");
var m_main = b4w.require("main");

m_cfg.set("background_color", new Float32Array([0.0, 0.0, 0.0, 0.0]));
m_cfg.set("alpha", true);

m_main.init(...);
```

See also:

[Alpha Compositing](#)

Postprocessing Effects

Table of Contents

- Postprocessing Effects
 - Motion Blur
 - Depth of Field
 - Screen-Space Ambient Occlusion
 - God Rays
 - Bloom
 - Outlining
 - Glow
 - Anti-Aliasing

Motion Blur

The motion blur effect can be used to improve the realism of an interactive scene. It is displayed as picture blurring when the camera or objects move.



Activation

Activate the Motion Blur panel on the Render tab.

Additional settings

Factor Effect appearance ratio. The higher this value is the stronger is the motion blur.

Decay Threshold Blur fade-out ratio. The higher this value is the more distinct is the effect. The default value is 0.01.

Depth of Field

The depth of field effect (DOF) can be used to accentuate a part of a scene. It is displayed as picture blurring nearer and further from the camera focus.



Activation

1. Select an active camera and go to its settings panel Camera (Object Data).
2. Then two options are available:
 - Select an object to use as the camera's focus in the Focus option of the Depth of Field panel. In this case moving away or approaching this object will cause a corresponding correction of the camera focus.
 - Set a non-zero value for the Distance on the same panel (in Blender units = meters). In this case the camera focus will be located at this distance from the camera and will move together with it.

Additional Settings

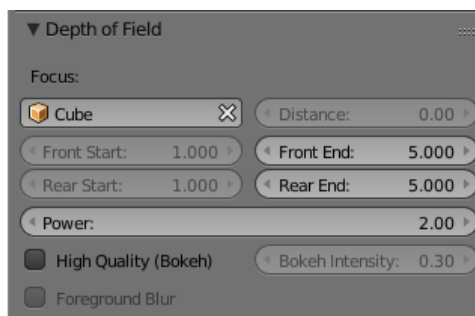

Focus Sets the focal object. By default, this field is empty.

Distance This parameter defines the focal distance. Available only if the Focus parameter hasn't been set beforehand (if the corresponding field is empty). Set to zero by default.

Front Start This sets the distance (in meters) from the focus to the nearest plane (relative to the camera) behind which blurring effect starts to occur. The default value is 1.0.

This parameter is available only if the High Quality (Bokeh) parameter is enabled.

Front End This sets the distance from the camera and the nearest plane (relative to the camera) behind which blurring effect reaches maximum strength (defined by the Power value). Default value is 5.0.

Rear Start This sets the distance from the focus to the furthest plane (relative to the camera) behind which blurring effect starts to occur. The default value is 1.0.

This parameter is available only if the High Quality (Bokeh) parameter is enabled.

Rear End This sets the distance from the camera to the furthest plane (relative to the camera) behind which blurring reaches maximum strength (defined by the Power value). Default value is 5.0.

Power Blurring ratio. The value of this parameter can vary from 0.1 to 10. The default value is 2.0.

High Quality (Bokeh) This enables high quality rendering of the depth of field effect. Activating this option:

- Enables bokeh effect and makes available the Bokeh Intensity parameter for adjusting the strength of the effect.
- Enables the Front Start and Rear Start parameters for setting soft transition between the distance from camera where the effect start to occur and the distance where it reaches its full strength.
- Enables Foreground Blur parameter that is described below.

The parameter is disabled by default.

Bokeh Intensity This value sets the strength of the bokeh effect. It can vary from zero to 1.0. Set to 0.3 by default.

Foreground Blur Enabling this option makes the engine to blur the silhouettes of the foreground objects, improving the quality of the effect at the cost of slight performance decrease. Disabled by default.

Screen-Space Ambient Occlusion

The screen-space ambient occlusion (SSAO) effect can be used to fake complex light reflections from objects. The basis of this effect is that the space between close objects is less accessible for diffused light and hence is darker.



Activation

Activate the Ambient Occlusion SSAO panel under the Render tab and set the Render Shadows parameter to AUTO or ON on the Render > Shadows panel.

Additional settings

Radius Increase The spherical sampling radius multiply factor when transferring from the internal sampling ring to the external one. The default value is 3.0.

Use Hemisphere Use a hemispherical sampling for shading instead of a spherical. Besides, it uses different shading law.

Use Blur Depth Test Use edge-preserving blur to SSAO if flag will be turned on. Otherwise, it uses blur which averages a 4x4 rectangle around each pixel.

Blur Depth Test Discard Value Influence of depth difference between samples on blur weight. It uses with Use Blur Depth Test activated flag. The default value is 1.0.

Influence SSAO appearance factor. The default value is 0.7.

Distance Factor Factor of SSAO decay with distance. The default value is 0.0 (i.e. no decay).

Samples Number of samples (the more samples there are the better is the quality but the poorer is the performance). The default value is 16.

God Rays

The god rays effect (aka crepuscular rays) simulates well-known natural phenomenon - the shining of illuminated air parts.



Activation

Activate the God Rays panel under the Render tab.

Additional settings

Intensity The effect appearance factor. The default value is 0.7.

Maximum Ray Length Rays length factor. Defines the step between samples of radial blurring. The default value is 1.0.

Steps Per Pass Number of steps per single sample. The default value is 10.0.

Bloom

Bloom appears when a picture has elements with a very different brightness. A glowing halo is created around the bright details.



Activation

Activate the Bloom panel under the Render tab.

Additional settings

Use Adaptive Use calculation of adaptive average luminance. Enabled by default.

Intensity Bloom intensity. Set to 1.0 by default.

Blur Bloom blurriness factor. Set to 4.0 by default.

Edge Luminance The boundary value of an element's relative brightness above which the bloom effect appears. Set to 1.0 by default.

Outlining

As a result of the outline glow effect, a luminous colored halo will be displayed around the object.



Activation

The outlining is activated programmatically via API. Different animation models can be applied such as constant glow, fading out glow, pulsatory glow and any other. In order to enable the outlining effect on a certain object, make sure that the Render > Object Selection panel's Enable property is set to ON or AUTO.

Additional settings

On the Object > Selection and Outlining panel:

Enable Outlining Permit using the outline glow effect on this object.

Duration Duration of glow animation, seconds. The default value is 1.

Period Repeat period of glow animation, seconds. The default value is 1.

Relapses The number of iterations of glow animation. If zero, animation is repeated forever. The default value is 0.

Outline on Select Activate glow animation upon selecting the object. In this case the Selectable option must be enabled. In case of a user-defined glow animation model, this option must be disabled in order to avoid conflict.

On the Render > Object Outlining panel:

Factor When this parameter decreases so does the thickness and the brightness of the halo around the object. The default value is 1.

The Render > Object Outlining settings are taken as default when the glow effect is initiated via API.

Glow

Effect of halo which is observed around emissive objects due to light scattering in the atmosphere and inside the human eye.

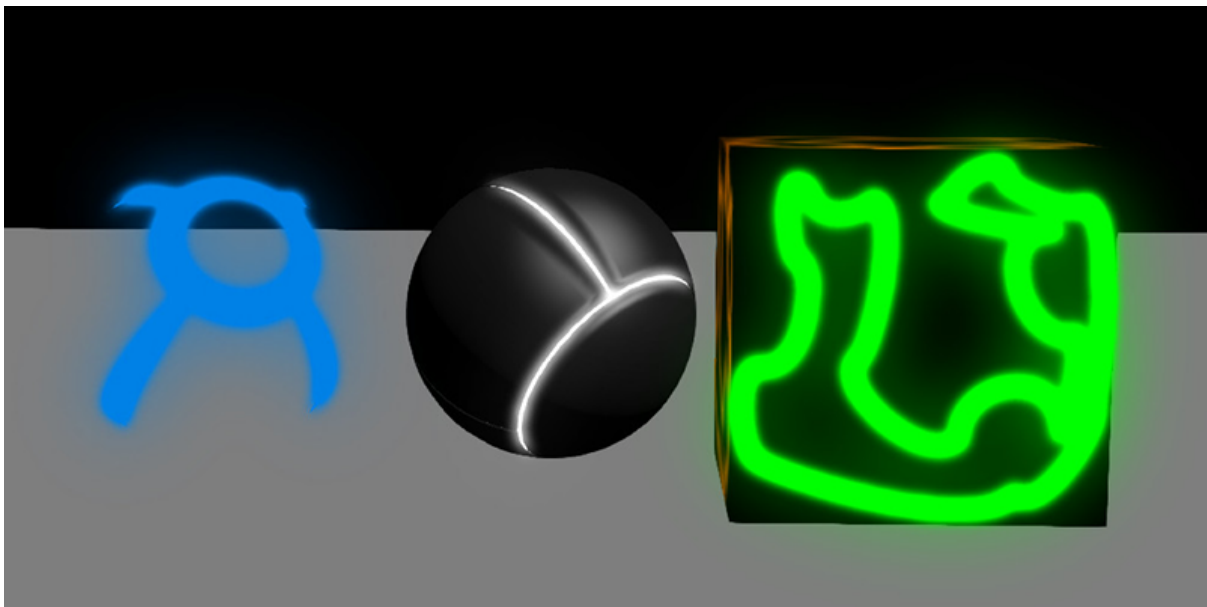

Activation

Add a `B4W_GLOW_OUTPUT` node to a node material. The Enable Glow Materials option on the Render > Glow Materials panel should be set to ON or AUTO.

Additional settings

Small Mask: Intensity Intensity of glow obtained through the smaller mask. The default value is 2.0.

Small Mask: Width Width of glow obtained through the smaller mask. The default value is 2.0.

Large Mask: Intensity Intensity of glow obtained through the larger mask. The default value is 2.0.

Large Mask: Width Width of glow obtained through the larger mask. The default value is 6.0.

Render Glow Over Transparent Objects Render the glow effect over transparent objects.

Anti-Aliasing

Anti-aliasing is used to reduce undesirable rendering artifacts (poor pixelization).

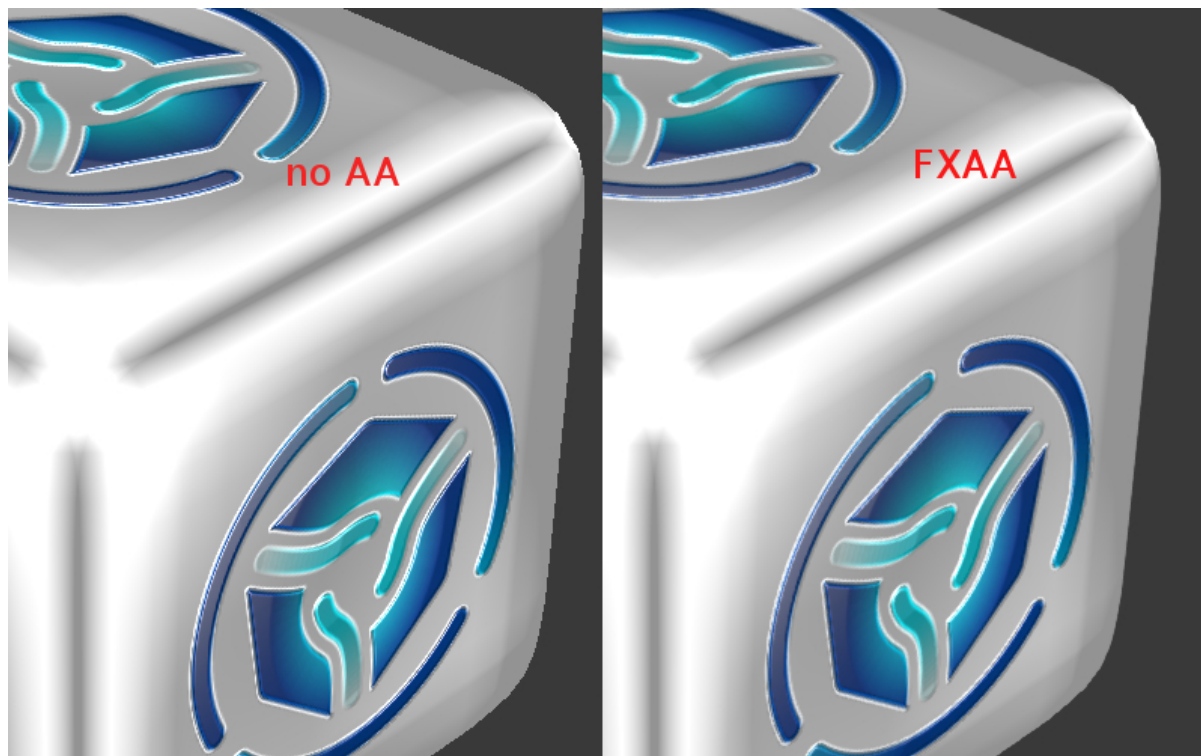

Activation

Select quality profile using AA Quality menu located on the Render > Anti-Aliasing panel.

- None - disable anti-aliasing,
- Low, Medium, High - enable anti-aliasing with the given quality profile.

Medium profile is used by default.

Additional settings

The anti-aliasing method is assigned simultaneously with the selection of the engine performance profile:

- low quality - no anti-aliasing,
- high quality and ultra quality - use the FXAA 3.11 algorithm (Fast Approximate Anti-Aliasing by Nvidia).

VR and AR

Table of Contents

- VR and AR
 - Virtual Reality
 - * Activation
 - * HMD Settings
 - Augmented Reality
 - * Setting Up
 - * Leap Motion

The following chapter describes Virtual Reality (VR) and Augmented Reality (AR) features of the Blend4Web engine and explains the basics of creating applications capable to work with these outstanding technologies.

Virtual Reality

There are numerous VR devices, and Blend4Web engine supports many of them. Using VR in a Blend4Web application does not require any specific changes made to the application itself.

The stereoscopic rendering mode is intended for viewing the content using special glasses. It is activated by an application via API.

Blend4Web supports several techniques of stereo image rendering: HMD (head-mounted display):

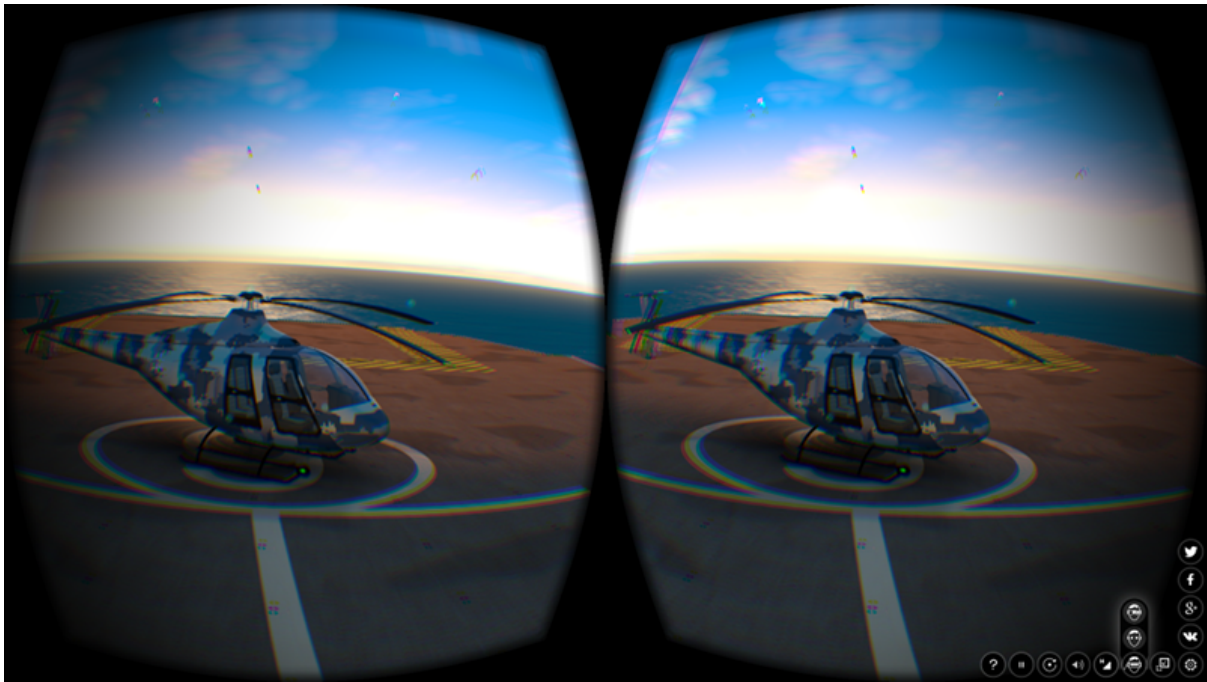

HMD is an experimental feature, for now it works only with the Eye type cameras. Side-to-side rendering:



Anaglyph:



Activation

To use HMD stereo rendering, you need to install Oculus' runtime utility (two versions are supported: the `chromium_webr_v1_win64.7z` in the root directory and the one in the Deprecated API folder). Windows and macOS versions can be found on the Oculus website in binary format, while Linux version should be compiled from the source code.

For now, the HMD is supported by the Chromium experimental builds and in the Firefox nightly builds.

Chromium settings.

Firefox settings.

To turn the stereo rendering on, you need to choose certain option in the settings, in the third column from the right, as shown on the picture.



For stereo rendering to work correctly, switching to the full screen mode is recommended.

HMD Settings



This group of settings allows a user to change various parameters in order to adjust whatever VR device they have to better view a certain 3D application or scene. There are two ways these settings can be accessed:

- Firstly, it can be found in the [Blend4Web Viewer](#) application under the [Stereo View](#) tab.
- And secondly, it can also be shown in an application by using the `show` method of the `hmd_conf` module, but doing this requires some programming. Examples of this method can be found in the `viewer.js` and `webplayer.js` applications (in the `m_hmd_conf` object).

Profile

This allows user to select a profile for a specific device. Currently, the following profiles are available:

- Custom
- Cardboard (2014)
- Cardboard (2015)

By default, Custom profile is selected.

Rendering Settings

Tray to lens-center distance This parameter specifies the distance between the phone frame and the center of the camera lenses.

This value can vary from 0 to 50. Default value is 32.

Interpupillary distance This parameter specifies the distance between the pupils of the user's eyes. Measured in millimeters.

This value can vary from 0 to 100. Default value is 64.

Screen to lens distance This specifies the distance between the screen of the phone and the camera lenses.

This value can vary from 0 to 100. Default value is 50.

Screen height The height of the screen.

This value can vary from 0 to 150. Default value is 63.

Screen width The width of the screen.

This value can vary from 0 to 200. Default value is 107.

Bevel width The thickness of the border around the image.

This value can vary from 0 to 20. Default value is 3.

Distortion coefficients This is used in order to compensate image distortion produced by the VR device lenses.

Both values can vary from 0 to 1. Default values are 0.34 for the first parameter and 0.55 for the second one.

Other control tools

Save Saves the settings.

Cancel Closes the setting interface without saving the settings.

Reset Restores default settings.

Augmented Reality

Augmented Reality feature in Blend4Web engine utilizes JavaScript port of the popular AR solution [ARToolKit](#).

In comparison with VR apps, creating an Augmented Reality application is a little more complicated, as the application itself should be properly set up beforehand, and certain hardware requirements have to be met.

System requirements are:

- A device with a web camera to run the application.

Note: If your device does not have a web cam, the application will still run, but AR features will not be available.

- A web browser with the AR support.

Setting Up

Blend4Web SDK features an example of an AR application available in the [Project Manager](#).

Note: This example is not included in the Blend4Web CE Lite

For an AR application to work properly, you will need a [marker](#).

Leap Motion

Leap Motion is a controller that can be used for tracking hand movements and gesture recognition. It can be used in conjunction with any supported VR device, or on its own.

Our [Code Snippets](#) application contains an example of using Leap Motion controller. If you are planning to develop applications that support the controller, you may want to examine this example thoroughly. You can also use it as a base for your own projects.

Leap Motion API is provided as a standard JavaScript library that can be included in the HTML page of the project. This library can be either included in the project or accessed remotely from Leap Motion's servers.

Textures

Table of Contents

- Textures
 - Texture Types
 - Generic Settings
 - Diffuse Map
 - Specular Map
 - Normal Map
 - Height Map. Parallax Mapping
 - Stencil Map
 - Video Textures
 - Environment Map
 - Mirror Map
 - Skydome
 - Special Texture Types

Textures are hand-made or procedurally generated images that can be applied to the model surfaces to add more detail. As a rule, the image pixels are assigned to the 3D surface points using texture mapping. For this reason they are sometimes referred to as maps.

Usually the textures are placed into [material](#) texture slots. They can be also used for [particle systems](#) parametrization and for creating the [skydome](#).

Texture Types

The Type drop-down menu (for selecting texture type) is located under the Textures tab. The engine supports the following texture types:

1. Image or Movie

In this case, the texture is defined by an image or a video file. Following file formats are supported:

- .PNG
- .JPG

It can be used for the following purposes:

- [diffuse map](#)
- [specular map](#), this can also be packed into the alpha channel of a diffuse texture
- [normal map](#)
- [height map](#); this must be packed into the alpha channel of a normal map; it is used for visualization of relief surfaces ([parallax mapping](#)).
- [stencil map](#)
- [video texture](#)

2. Environment Map

- [mirror map](#)
- [skydome texture](#)
- used for implementation of an [environment lighting](#) method

3. None

- applied to the Blender's default scene cube. It is also used for [rendering a scene to texture](#) and for [rendering canvas textures](#).

4. Blend, gradient

- is used in [particle systems](#)

Generic Settings

Dimensions Bitmap dimensions for image textures (image width and height in pixels) should be a 2^N number, i.e. 4, 8, 16, 32, 64, 128, 256, 512, 1024, 2048, 4096 px. Using textures with other dimensions (so-called NPOT) is supported but is not recommended. Dimensions should be at least 4 pixels for the correct texture compression. Normally square images are used (e.g. 512 x 512 px), however rectangular ones can be used too (e.g. 4 x 128 px). Using images bigger than 2048 px is not recommended.

Image Mapping > Extension Texture coordinates interpretation mode (Wrap Mode in WebGL). This is available for Image or Movie texture type. In case of Repeat value the engine sets the REPEAT mode for the texture. In this case the integer part of the texture coordinates is ignored and the fractional part is used. In all other cases (for example Extend) the engine sets the CLAMP_TO_EDGE mode. In this case the texture coordinates are limited by the [0, 1] segment. The default value is Repeat.

Mapping > Coordinates Texture coordinates type. Supported types are UV (use UV map), Normal (use direction at the camera; available only for diffuse maps; used for the creation of material capture, matcap) and Generated. The default value is Generated.

Mapping > Size Scaling the UV map along respective axes. The default values are 1.0.

Export Options > Do Not Export Do not export the texture.

Export Options > Disable Compression Disable texture compression (using DDS texture format) for this texture. Used in cases when [texture compression](#) deteriorates the image quality. For example it's recommended to disable compression for mask textures used to mix different parts of materials.

Export Options > Shore Distance Map Used in [outdoor rendering](#).

Export Options > Anisotropic Filtering Anisotropic filtering factor for the individual texture. It has priority over the similar parameter for the scene. The default value is DEFAULT (i.e. use the scene settings).

Water Foam The foam texture. Used by the water rendering material.

Note: Texture compression is disabled for textures used as normal maps.

Diffuse Map

A diffuse map is used for specifying scattered light distribution (the Lambert model).

Activation

Enable the Diffuse > Color checkbox on the Textures > Influence panel.

Additional Settings

Influence > Diffuse > Color Influence of the texture on the diffuse color. The default value is 1.0.

Influence > Blend The type of the interaction with the material color (Material > Diffuse > Color), or with the vertex color if the Vertex Color Paint checkbox is enabled. The following types are supported: Mix (mixes with the color), Multiply (multiplies by the color). The default value is Mix.

Specular Map

The specular map is used for specifying the reflected light color distribution (the Phong model).

Activation

Enable the Specular > Color checkbox on the Textures > Influence panel.

Additional Settings

Influence > Specular > Color The influence of the texture on the reflected light color. The default value is 1.0.

Influence > Blend The type of interaction with the reflected light color of the material (Material > Specular > Color). Mix (mixes with the color) is the only supported type. The default value is Mix.

The specular map can be packed to the alpha channel of a diffuse texture for optimization purposes. In such case it is required for the texture to enable the Diffuse > Color and Specular > Color checkboxes simultaneously. The color range is limited by gray tints.

Normal Map

A normal map is used for specifying the distribution of surface normals (perpendiculars) with the purpose of the relief detalization. The information about the normals should be stored in the texture space of coordinates. Normal maps baked in the object space of coordinates are not supported.

Activation

Set the Image > Color Space parameter to Non-Color.

Enable the Geometry > Normal checkbox on the Textures > Influence panel.

Additional Settings

Influence > Geometry > Normal Normal map influence on the resulting normals calculation. The default value is 1.0.

Height Map. Parallax Mapping

A height map contains information about the distribution of relative relief heights. The higher the surface level is, the brighter is its color. A height map combined with a normal map is required for the implementation of relief surface effect (parallax mapping). A height map should be present in the alpha channel of a normal map.

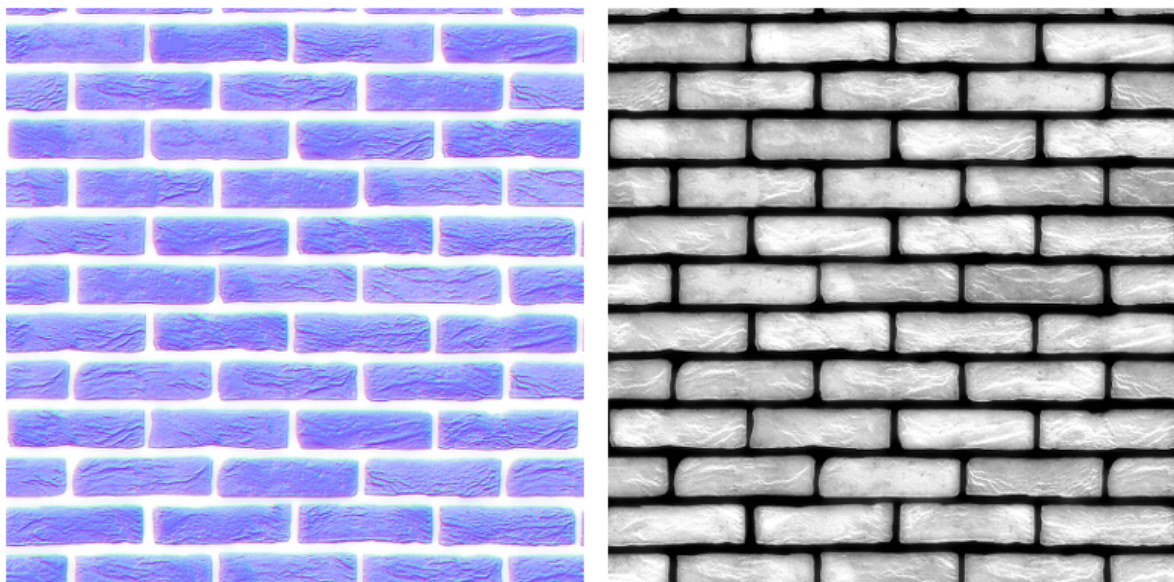

Activation

For the normal map enable the Parallax panel in addition to the Geometry > Normal checkbox.

Additional Settings

Parallax > Parallax Scale Influence factor for the relief surface effect. The default value is 0.03.

Parallax > Parallax Steps The number of iterations for the relief surface calculations. Bigger value leads to better quality but is more computationally expensive.

Parallax > Parallax LOD distance Distance at which the parallax effect is observed.

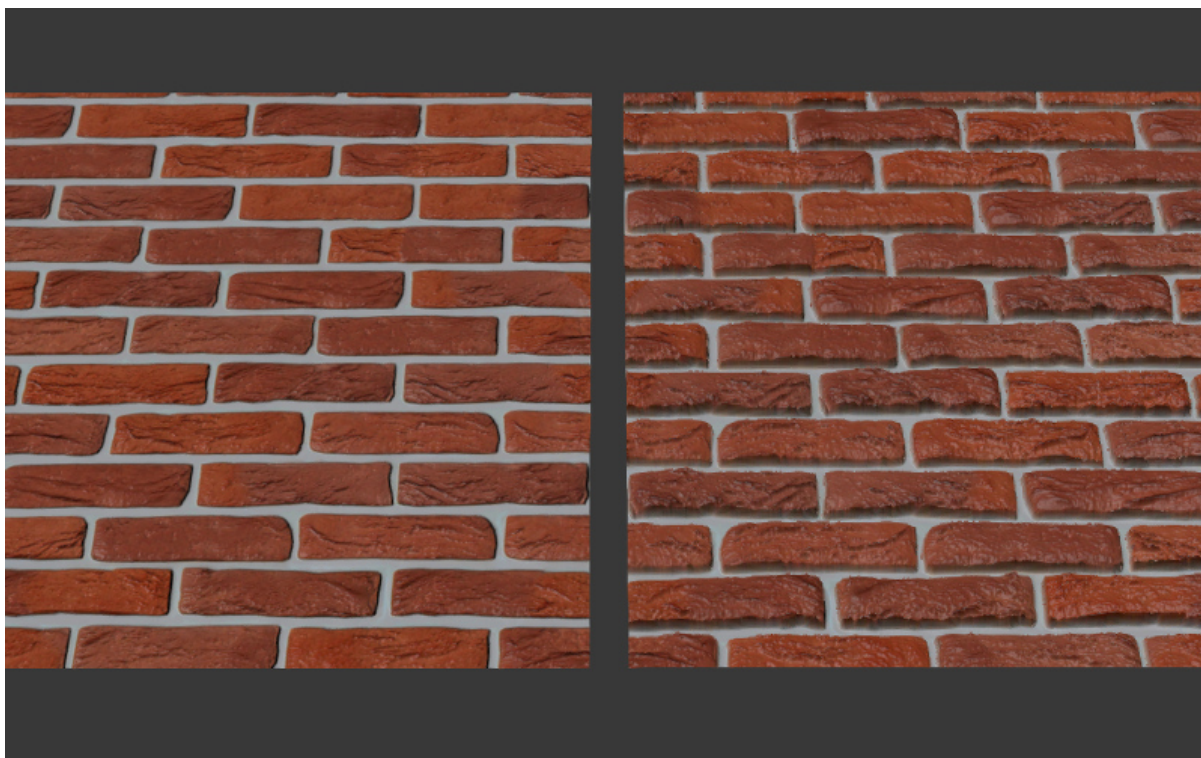

Stencil Map

The special purpose texture (colorful or grayscale) contains information about the distribution of other texture surfaces.

Activation

1. In case of node materials a stencil map should be used in the corresponding node structure.
2. In case of generic materials a stencil map should be located in a texture slot between two mixed diffuse textures. A stencil map requires to set both the RGB to Intensity and the Stencil checkboxes on the Textures > Influence panel.

Additional Settings

In the case of generic materials one of the mixed diffuse textures can have the Normal (“matcap”) texture coordinates type.

Limitations

In case of generic materials the engine only interprets the red channel of a stencil map. Specular maps or normal maps (if any) are not being mixed. The Mapping > Size setting is extracted from the first texture and is applied to all remaining textures.

Example

The apple model material has the following textures: a normal map, a diffuse texture with a specular map in its alpha channel, a stencil map, a diffuse “matcap” map, an environment map.

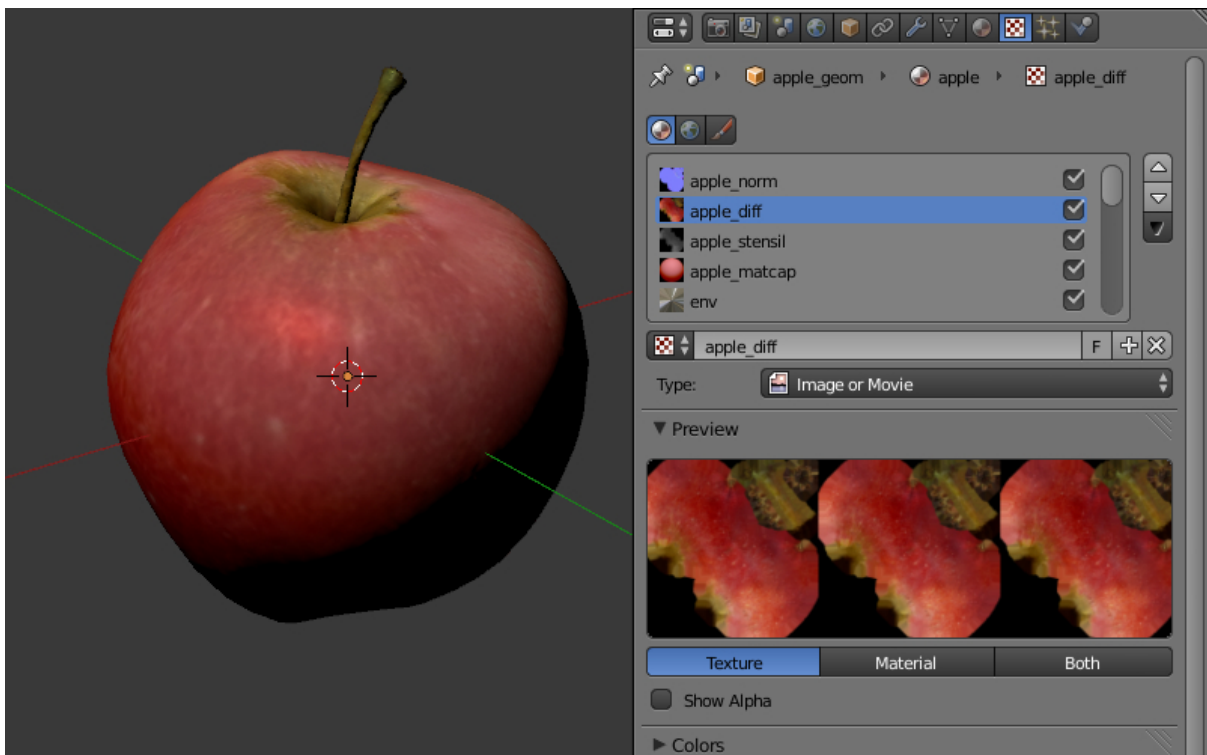

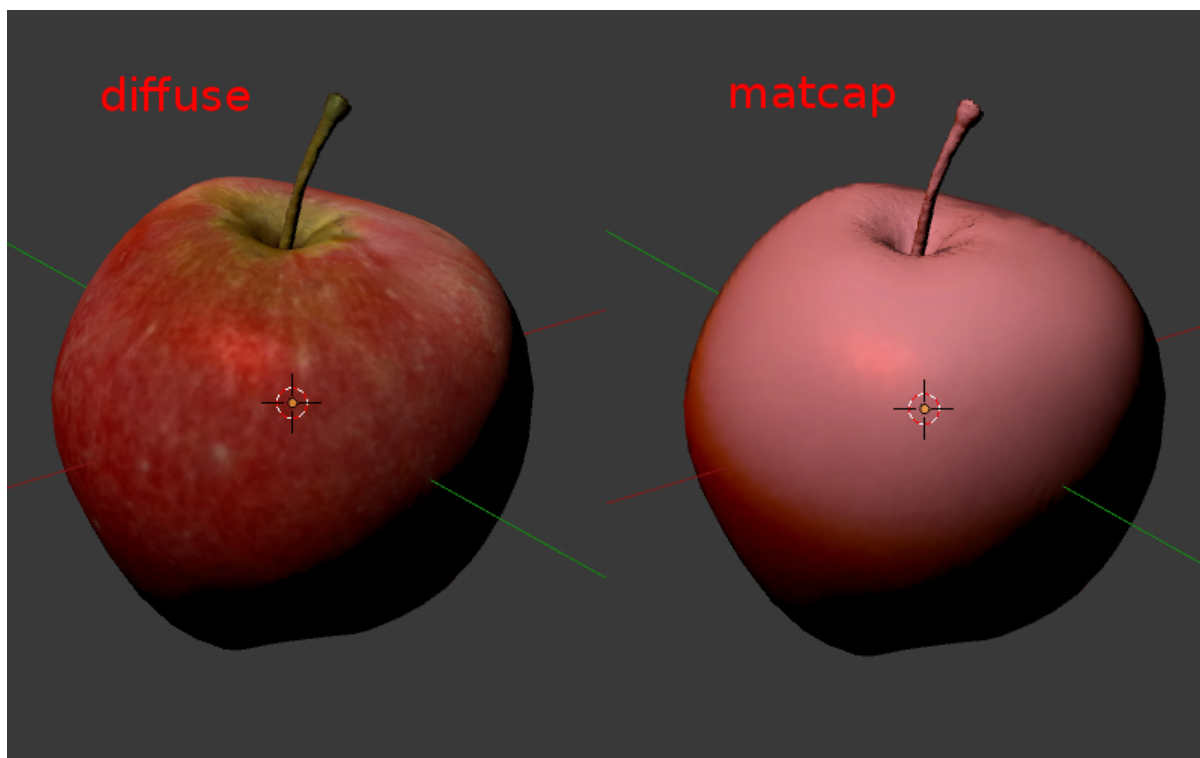

Video Textures

A video file can be used as a texture if Image or Movie texture type is selected.

Note: Video textures support playing back just video tracks. Audio tracks should be played back by using a SPEAKER object.

Supported formats (containers):

- webm, VP8 codec (Chrome, Firefox)
- m4v, H.264 codec (Chrome, Safari, IE)
- ogv, Theora codec (Chrome, Firefox)

We recommend to use WebM as a basic format. It is an open standard supported by the majority of browsers and offers good picture quality.

Note: Files saved in mp4 and ogg formats have different extensions for audio and video data: .mp4 and .ogg extensions are used for sounds, .m4v and .ogv - for video.

Converting resources between different formats is described in the [corresponding section](#).

Setting up the Texture

The following settings are available for video textures on the Texture > Image panel:

Image > Frames Length of the played fragment in frames.

Image > Offset The number of the frame from which the video playback starts.

Image > Cyclic Start video playback afresh each time it finishes.

Image > Allow NLA Play back the texture as part of an NLA track. Additionally, enable NLA in the global scene settings through activating Scene > NLA. Enabled by default.

For NLA-controlled textures the following option is also applicable:

Image > Start Video playback delay (in frames) when using non-linear animation.

For non-NLA-controlled textures the following option is also applicable:

Image > Auto Refresh Play back the video immediately after the scene is loaded.

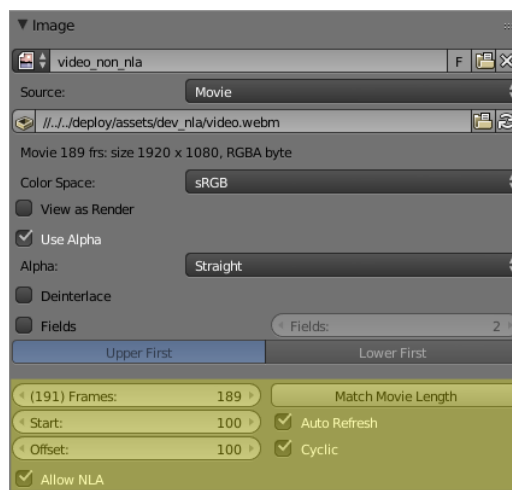

The video playback rate can be increased. To do this set Scene > Dimensions > Frame rate to a value which is different from the FPS value for the videos. Video playback rate is increased proportionally to the ratio of the scene's FPS and the video's FPS.

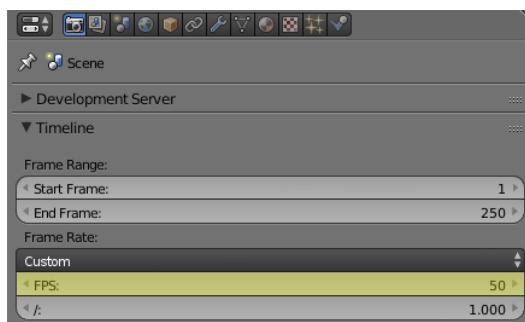

Note: When video textures are used together with NLA, the video playback can be not corresponding with Blender settings. Namely, there can be observed some lagging withing 5-6 frames due to starting/pausing delay of the <video> HTML element.

Specifics of Mobile Devices

The peculiarities for mobile devices are as follows:

1. Normal operation of video textures on iPhone is not possible because these devices play back videos via the standard iOS video player. For these devices you need to convert your videos to special .seq format by using our [converter](#).
2. some devices only support playing back only one video file.
3. stable operation is not guaranteed if the Offset value is not zero.
4. not all devices support changing the video playback rate.
5. iPad and iPhone do not provide the possibility to control the audio volume for video, and so the audio track should be removed from the video before the file is added to Blender.

Environment Map

An environment map can be used as a [mirror map](#), as a static [sky texture \(skydome\)](#) and also for implementation of an [environment lighting](#) method.

The engine considers it as a cube texture. Environment map bitmaps should contain 6 projected environment images, packed in 2 rows 3 pieces in each (a Blender format). Bitmap dimensions for each image should follow the 2^N rule (512, 1024 etc).

It is recommended to use the lossless format (PNG) in order to avoid seams.

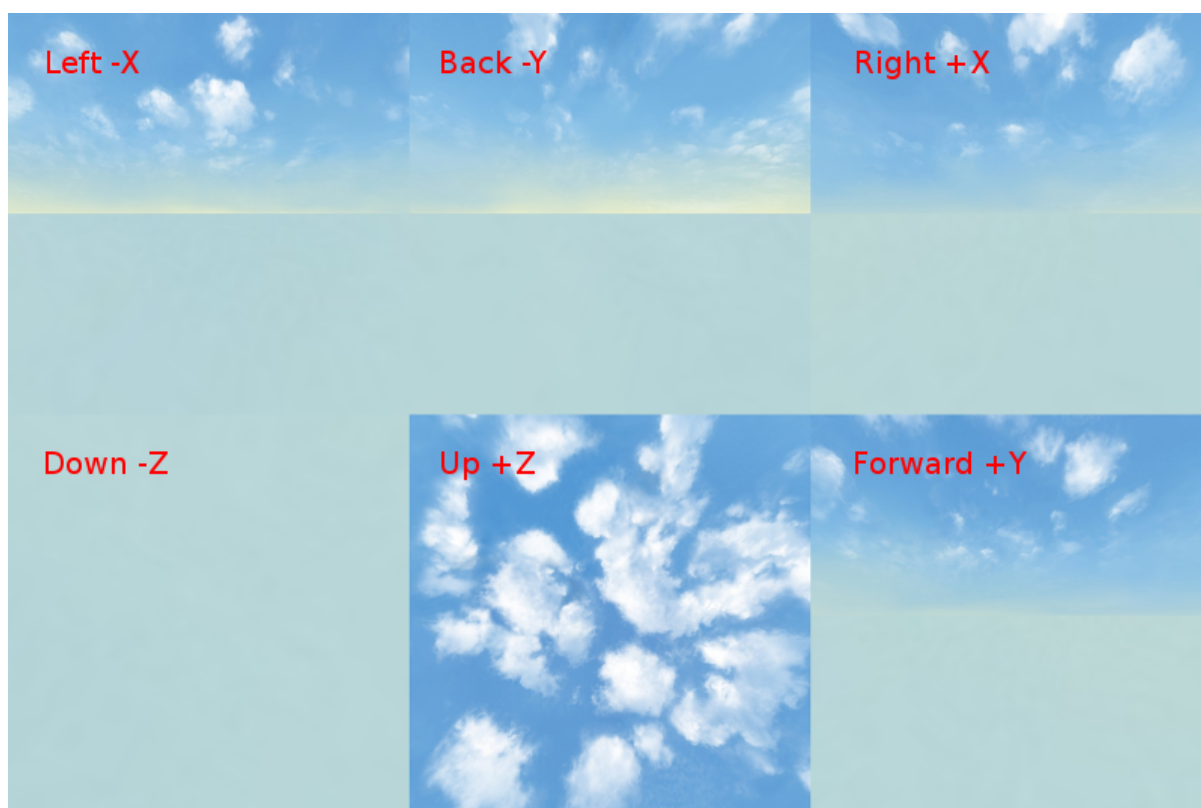

Making Environment Maps

Blender has an option for baking a scene into an environment map. To do this:

1. Create a scene for baking.
2. Add an empty object in the supposed point of view (Add > Empty).
3. Go to the World tab then to the Textures tab and create a new texture with the Environment Map type.
4. On the Environment Map panel select the Static source, then select the empty object in the Viewport Object field, then set the 2^N dimension (512, 1024 etc).
5. Render the scene by pressing F12 (a camera is required).
6. Save the environment map into a file.

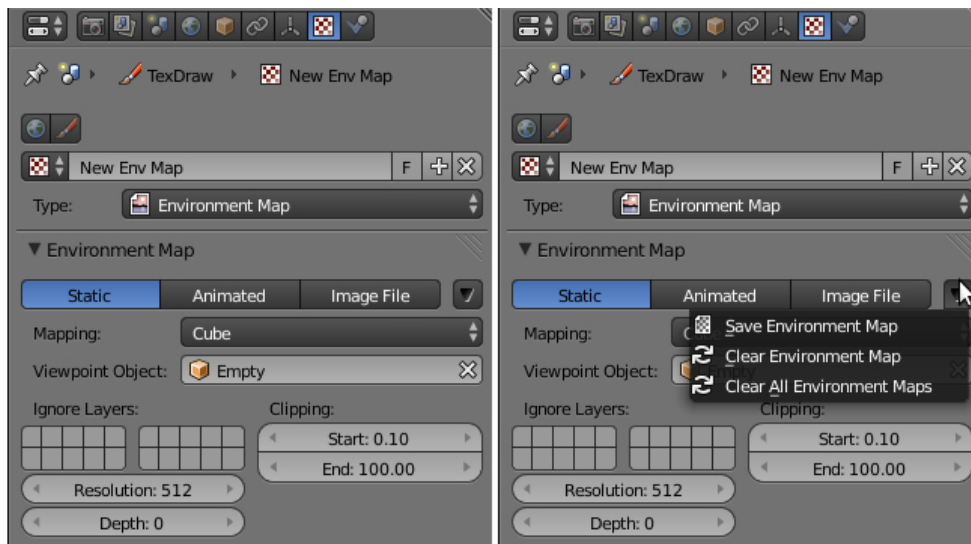
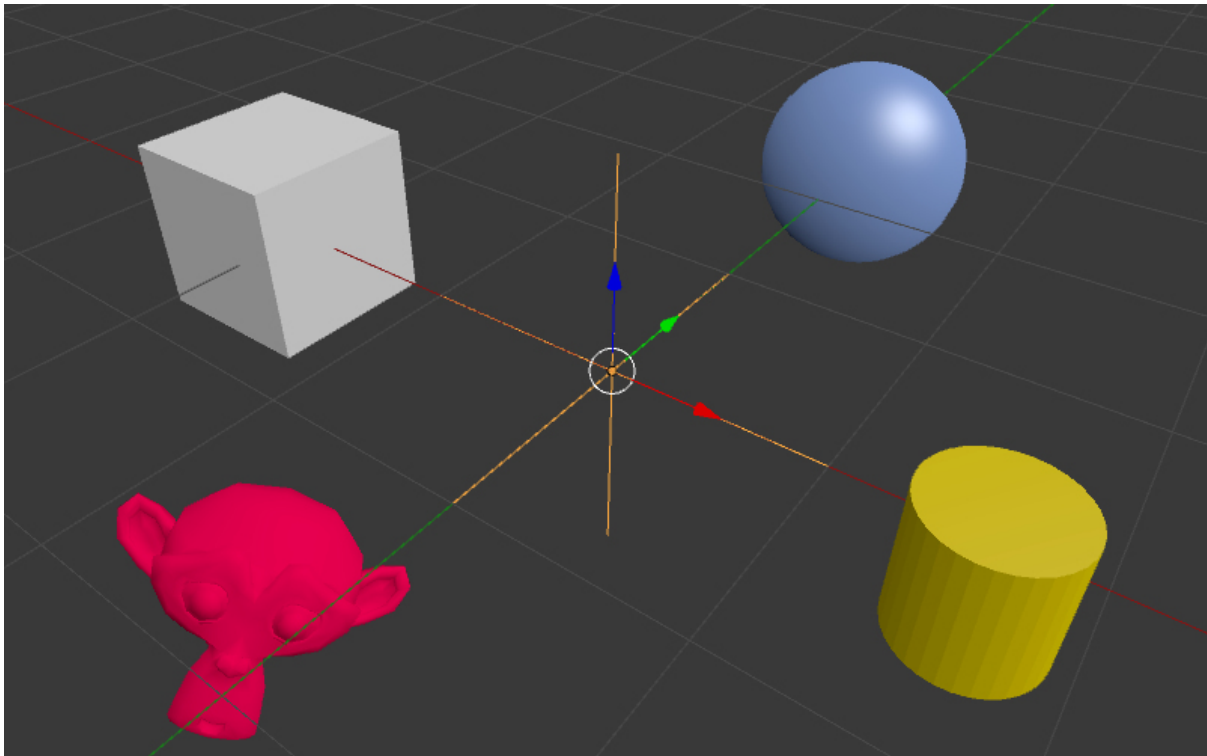

Mirror Map

A mirror map is used to visualize the surface reflection. This is an environment map.

Activation

Select the Environment Map texture type (Type). Enable the Shading > Mirror checkbox on the Textures > Influence panel.

Additional Settings

Influence > Shading > Mirror The degree to which the mirror map affects the reflection. The default value is 1.0.

See also:

Static reflection.

Skydome

A skydome is used to visualize an infinitely far environment (for example the sky). This is an [environment map](#).

Can be also used to implement one of the [environment lighting](#) methods.

Activation

Create a world texture of Environment Map type. Select the Export Options > Sky Texture Usage > SKYDOME option. Enable World > Render Sky under the World tab.

Note: The behavior of the texture is intentionally made as close as possible to the Blender internal render. That's why the texture may not be displayed upon its default settings. In order to make the texture visible, enable the Influence > Horizon checkbox on its panel and set the Horizon value to 1.0.

Note: To imitate [environment lighting](#) you can select the Export Options > Sky Texture Usage > ENVIRONMENT_LIGHTING option. Also, you should select the corresponding option in the world settings: Environment Lighting > Sky Texture.

To use the world texture both for skydome and for environment lighting, select Export Options > Sky Texture Usage > BOTH.

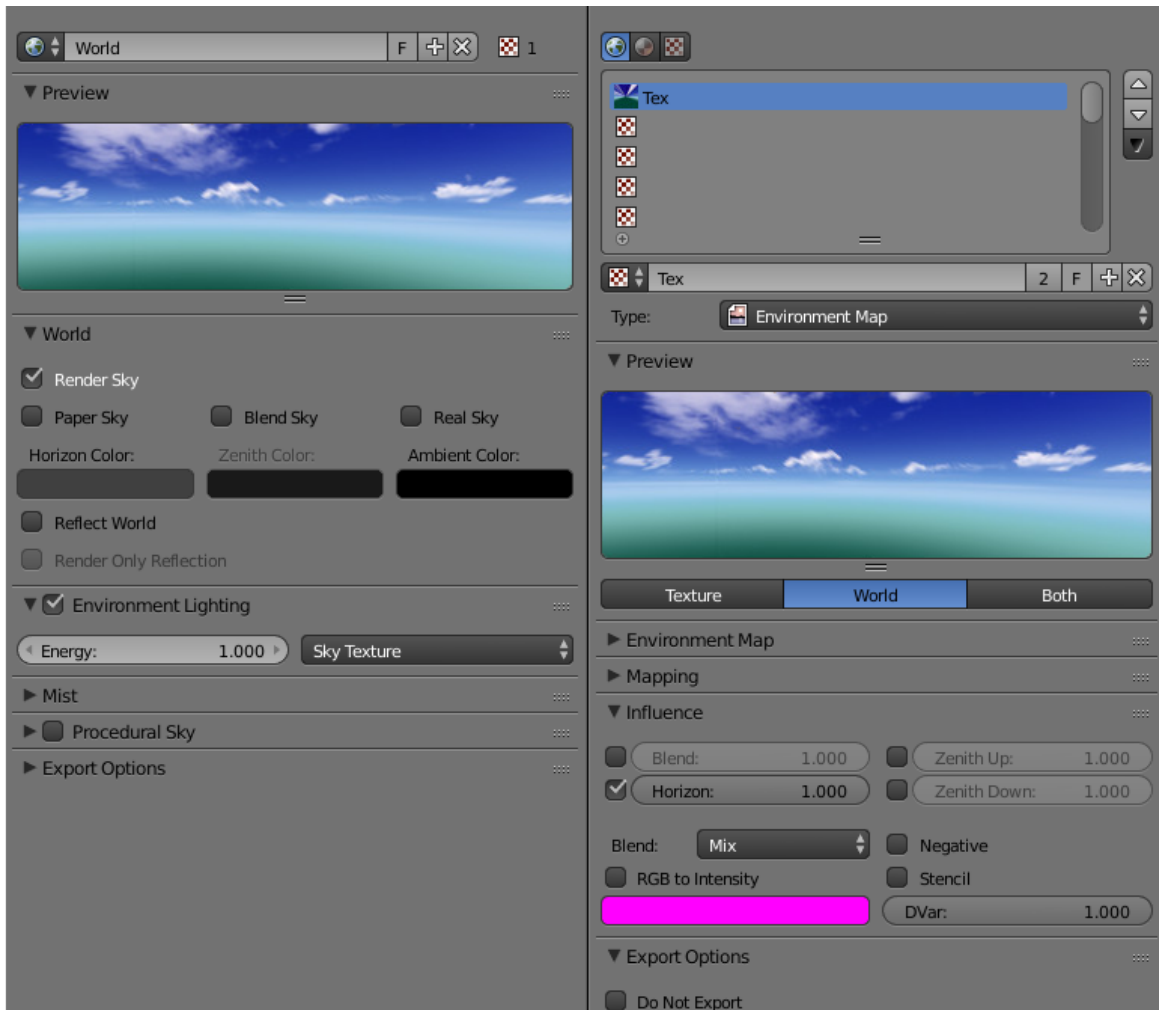

Additional Settings

The engine also supports parameters from the world texture's Influence panel which are used for sky rendering. Mixing of the world texture with color depends on the World > Horizon Color and World > Zenith Color parameters, as well as on the Paper Sky, Blend Sky and Real Sky options. All mixing options are supported (Mix, Add, Multiply etc).

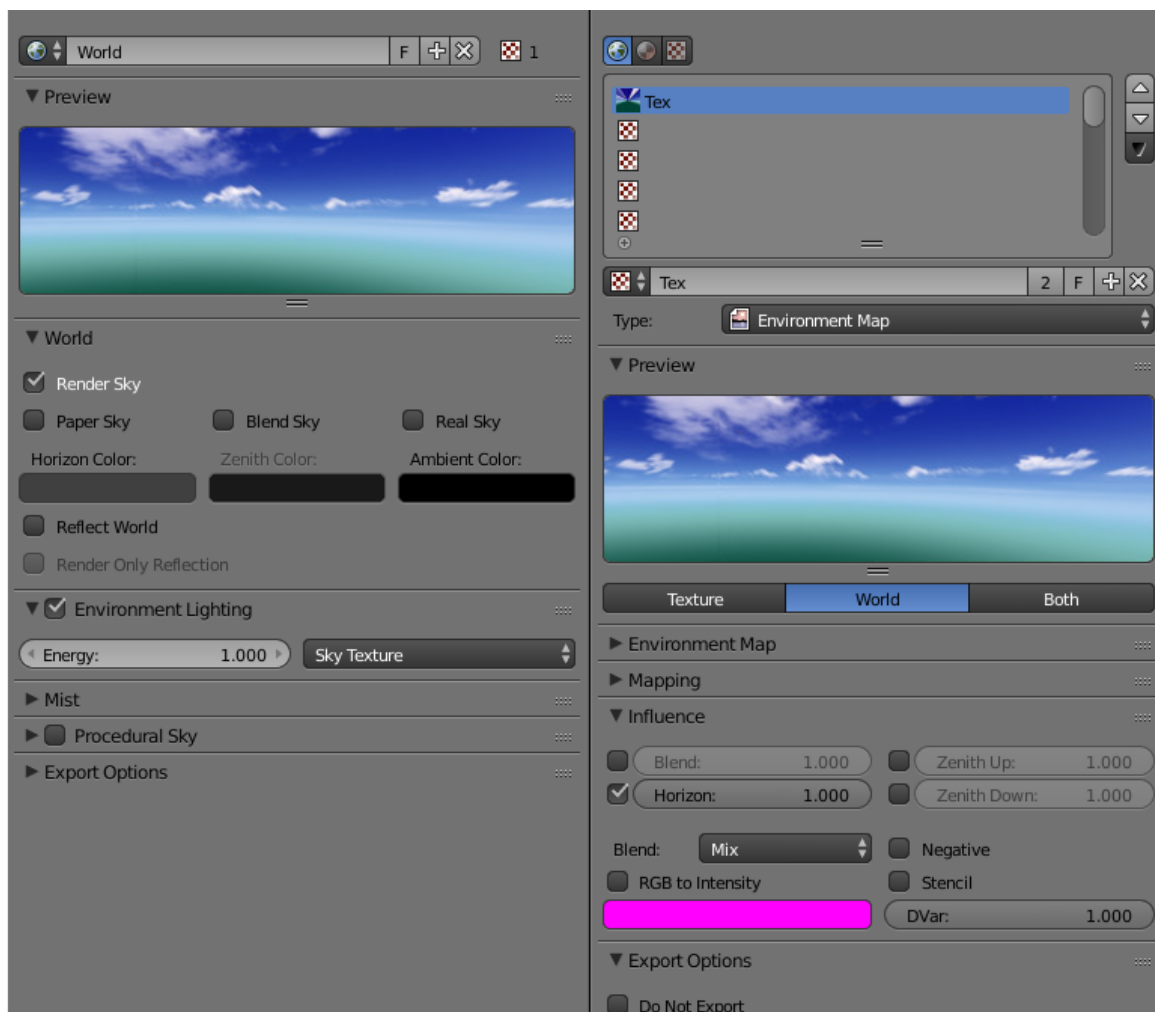

Note: The Influence panel parameters only affect the sky rendering. They do not affect environment lighting by any means.

Special Texture Types

In order to use such textures, select None type under the Textures tab.

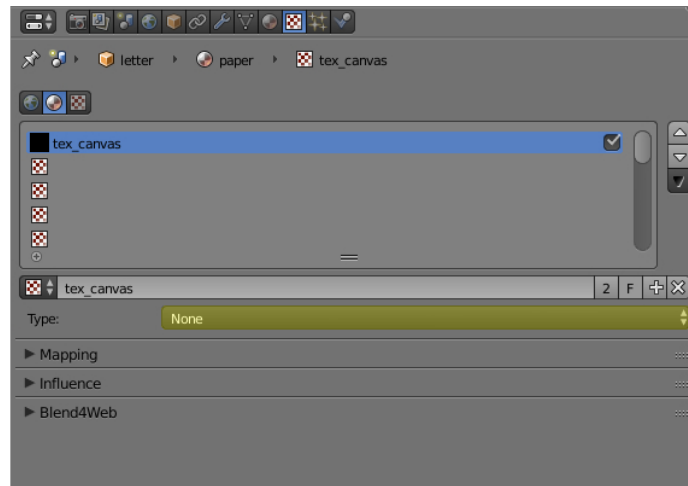

On the Textures > Export Options panel, you can set up properties for these textures:

Export Options > Source Type Select texture type: Scene - for rendering a 3D scene into the texture, Canvas - for using <canvas> HTML element and None - for indicating of its absence.

Export Options > Source ID The name of the scene which will be rendered into the texture (for Scene), or ID of the <canvas> HTML element (for Canvas).

Export Options > Source Size Texture resolution.

Export Options > Extension [Texture coordinates interpretation mode](#). Default is Repeat.

Export Options > Enable Mipmapping Enable mipmapping for the Canvas texture. Enabled by default.

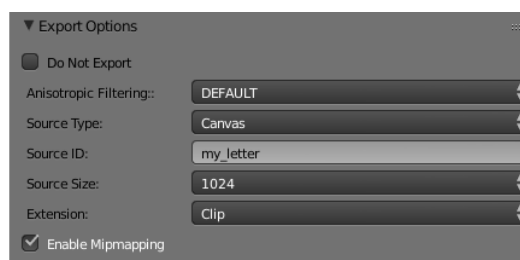

Render-To-Texture

An image of a 3D scene rendered in real time also can be used as a texture for an object in another scene (“main” scene). This technique is known as render-to-texture (RTT) and can be activated by following these steps:

1. Create an additional scene that will be rendered to the texture.
2. For convenience, give this scene a unique name.

3. Create a World setting for this scene.
4. Add the objects you need to the scene.
5. Add a camera to the scene and set it up.
6. Then, switch to the main scene.
7. Select the target object and create a UV map for it.
8. Create a texture that will act as the rendering target.
9. Set the None type for this texture.
10. Set the UV value for the Coordinates parameter under the Mapping tab.
11. Select the Scene type in the Export Options > Source Type menu.
12. Specify the name of the source scene in the Export Options > Source ID field.
13. Set the texture size in the Export Options > Source Size field (in pixels).



The engine also supports the cyclic rendering of scenes to each other.

Note: A project should contain at least one scene which is not rendered by any other scenes.

Canvas textures

A `<canvas>` HTML element can be used as a texture. It can be modified via API.

Set the `None` type for the texture of the target object on the main scene, and select the `Canvas` type in the `Export Options > Source Type` menu. Set the texture size in the `Export Options > Source Size` field (in pixels).

Use the textures module to handle such textures. See the example below.

```
var m_tex = require("textures");
...
var obj = m_scenes.get_object_by_name("NAME");
var ctx = m_tex.get_canvas_ctx(obj, "TEXTURE_NAME");
...
// operations with canvas context
...
m_tex.update_canvas_ctx(obj, "TEXTURE_NAME");
```

Use `get_canvas_texture_context()` to obtain a context - this method requires the `"canvas_id"` identifier which should be defined in Blender. After `operations with the context`, the `update_canvas_ctx()` function has to be called which will render modifications of the `"canvas_id"` element.

Note: If one `Canvas` type texture is assigned in Blender to several different objects, then after engine loading it still will be one texture and not several different ones. Any changes applied to it will be applied to all objects using this texture, which can be useful for optimization purposes. In case this effect is not needed, you should assign different textures in Blender or use `deep copy` after engine startup.

Particle System. Fluids

Table of Contents

- Particle System. Fluids
 - Usage
 - * Necessary Steps
 - * Recommended Additional Settings
 - Setup
 - * Basic Settings
 - * Emission Settings
 - * Direction Settings
 - * Rotation Settings
 - * Physics Settings
 - * Rendering Settings
 - * Supported Settings for Force Field Influence
 - * Engine Specific Settings
 - Textures in Particle Systems
 - * Textures of the Particle's Material
 - * Textures of Particle Systems

The particle system is intended to visualize phenomena which are caused by the movement of numerous small objects such as smoke, fire, water splashes and other.



A particle system requires an emitter - an object which defines the location and the direction of the outgoing particles flow.

Usage

Necessary Steps

1. Add a mesh emitter to the scene.
2. Create a material for particles on the emitter, for example of the Halo type. The Surface material type with a mandatory diffuse texture is also supported.
3. Add a particle system on the emitter.
4. Initiate the engine playback. Two options are available:
 - “cyclic emission” - enable the Emission > Cyclic emission option for the particle system and the Animation > Apply Default Animation for the emitter.

- “non-cyclic animation” - enable the Animation > Apply Default Animation option for the emitter.

Recommended Additional Settings

1. Set the Add transparency type for the particles' material.
2. Disable emitter rendering if needed using the Particles > Render > Emitter checkbox.
3. If an emitter is required on a scene use additional materials for it. In this case select the particles' material in the Particles > Render > Material menu on the particles settings panel.
4. If the Surface material type is used it is required to add a diffuse texture (normally with the alpha channel) to this material. Select UV in the Mapping > Coordinates menu. Make sure that the emitter's mesh has a UV layer.

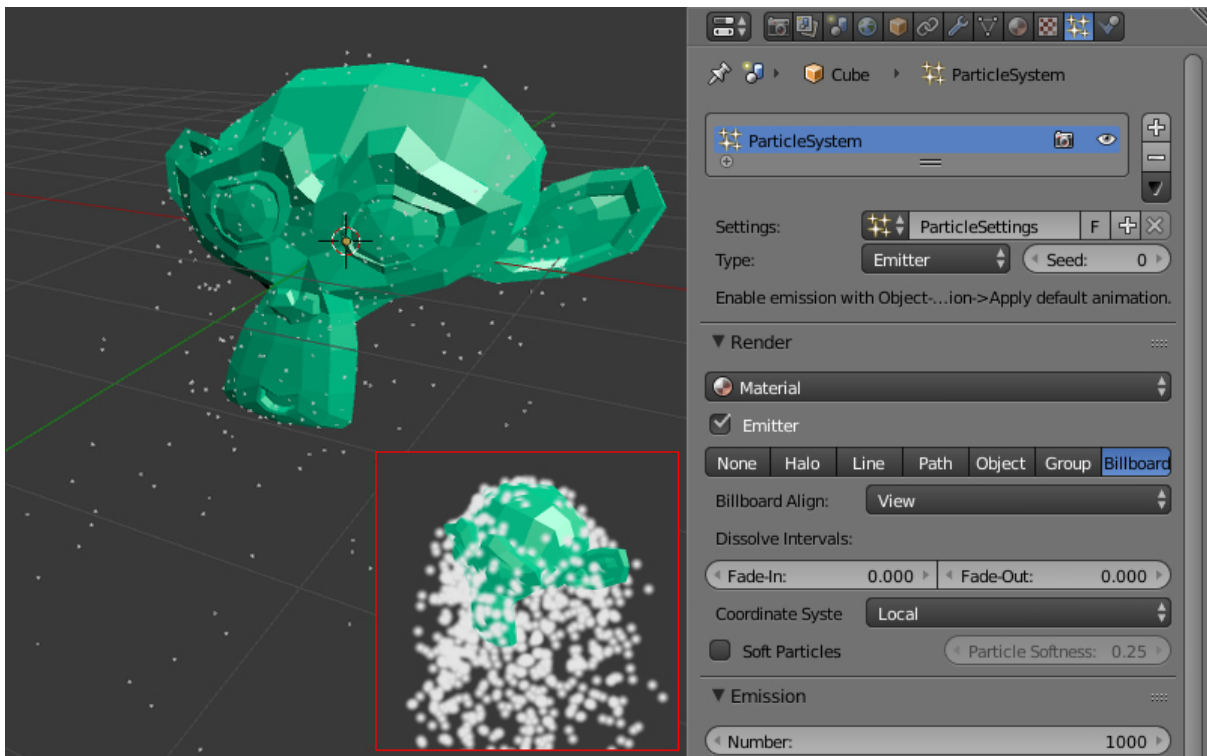

Setup

The particle system parameters can be set up under the Particles tab. Multiple particle systems per emitter are supported.

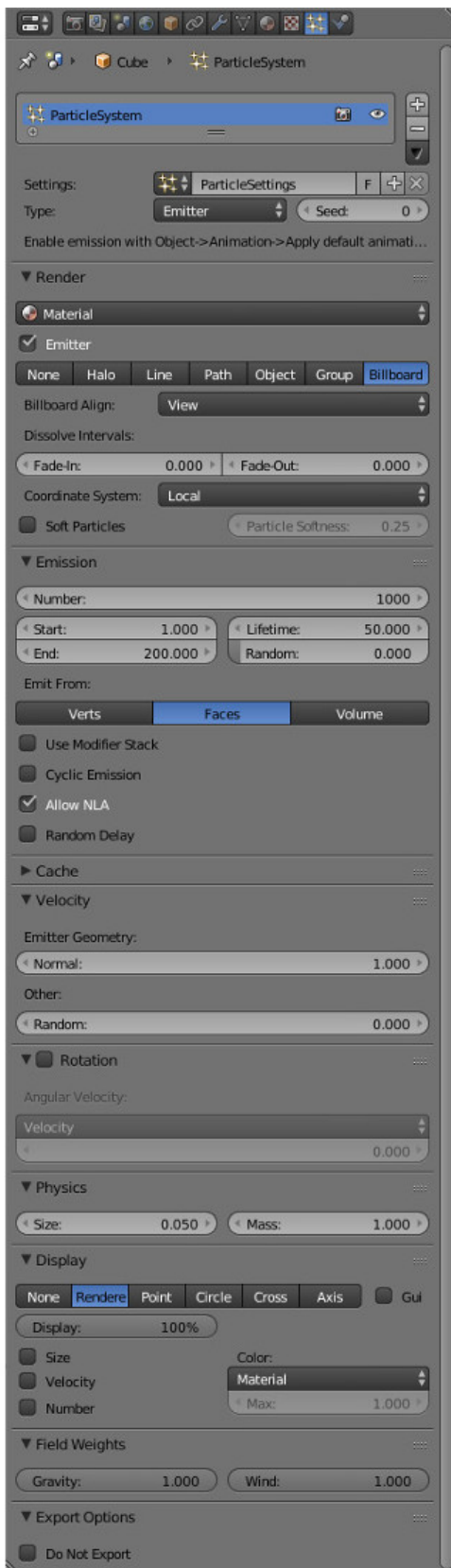

Basic Settings

Name Particle system name. The default name is “ParticleSystem”.

Settings Reference to the settings datablock of the particle system. The datablock settings can be shared between different particle systems.

Type Particle system type: Emitter or Hair. Hair particle systems can be used to create numerous copies of an object (so called instancing). The default is Emitter.

Seed Index in the table of random numbers which are used for particle system generation. The default value is 0.

Emission Settings

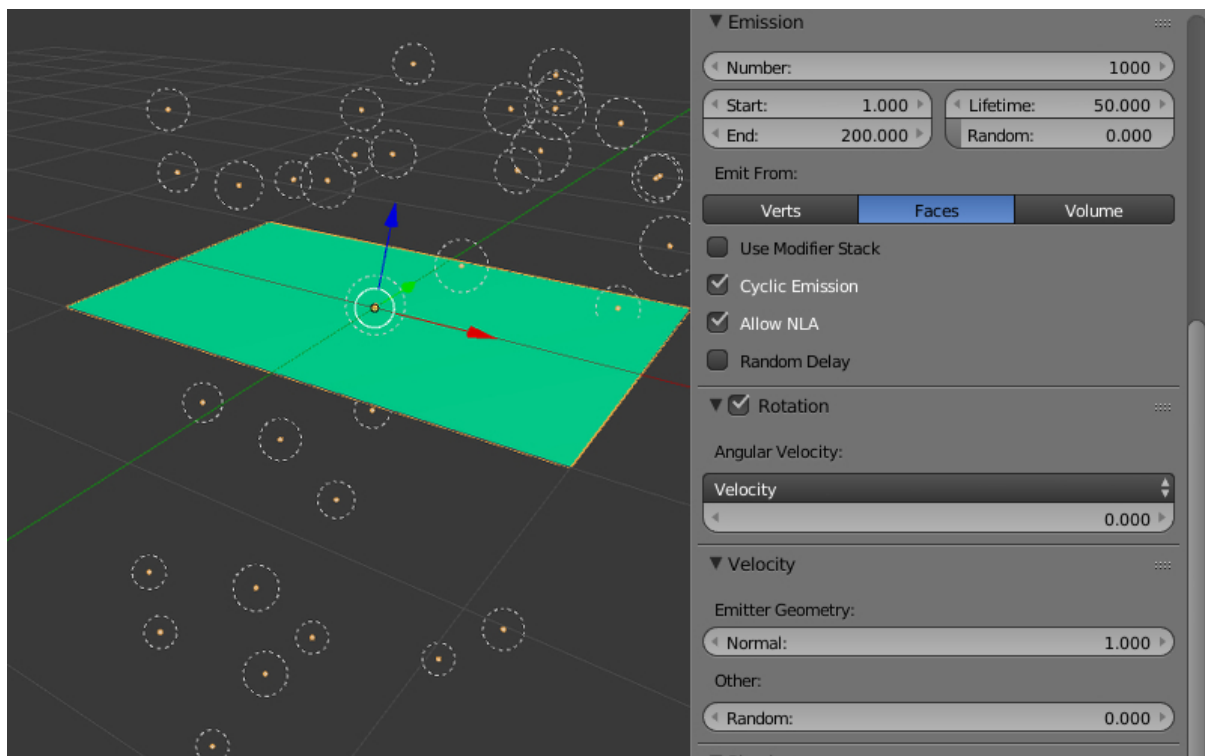

Emission > Number Number of particles. The default value is 1000.

Emission > Start The first frame after which the emission of particles starts. The default value is 1.0.

Emission > End The last frame after which the emission of particles ends. The default value is 200.0.

Emission > Lifetime The lifetime of particles measured in frames. The default value is 50.0.

Emission > Lifetime > Random The random factor for the lifetime. The default value is 0.0.

Emission > Emit From Emission source type. The following types are supported: Verts (emit from vertices), Faces (emit from polygons). The default is Faces.

Emission > Cyclic emission The option enables the cyclic emission mode. It can be used for permanent effects (such as smoke, burning, water splashes). It is recommended to set the **Emission > Start** value to zero. Disabled by default.

Emission > Allow NLA Activating this option allows particle emission to be controlled by NLA. Enabled by default.

Emission > Random Delay The option enables a random emission time for particles. Disabled by default.

Direction Settings

Velocity > Emitter Geometry > Normal Factor influencing the emission along the emitter's mesh normals. The default value is 1.0.

Velocity > Other > Random Factor of randomization for emission direction. The default value is 0.0.

Rotation Settings

Rotation > Angular Velocity > Mode Mode for particle billboards self-rotating. Hair particle system supports all the types of rotation and Emitter supports only Velocity.

Rotation > Angular Velocity > Factor Factor of rotation velocity for particle billboards. The default value is 0.0.

Physics Settings

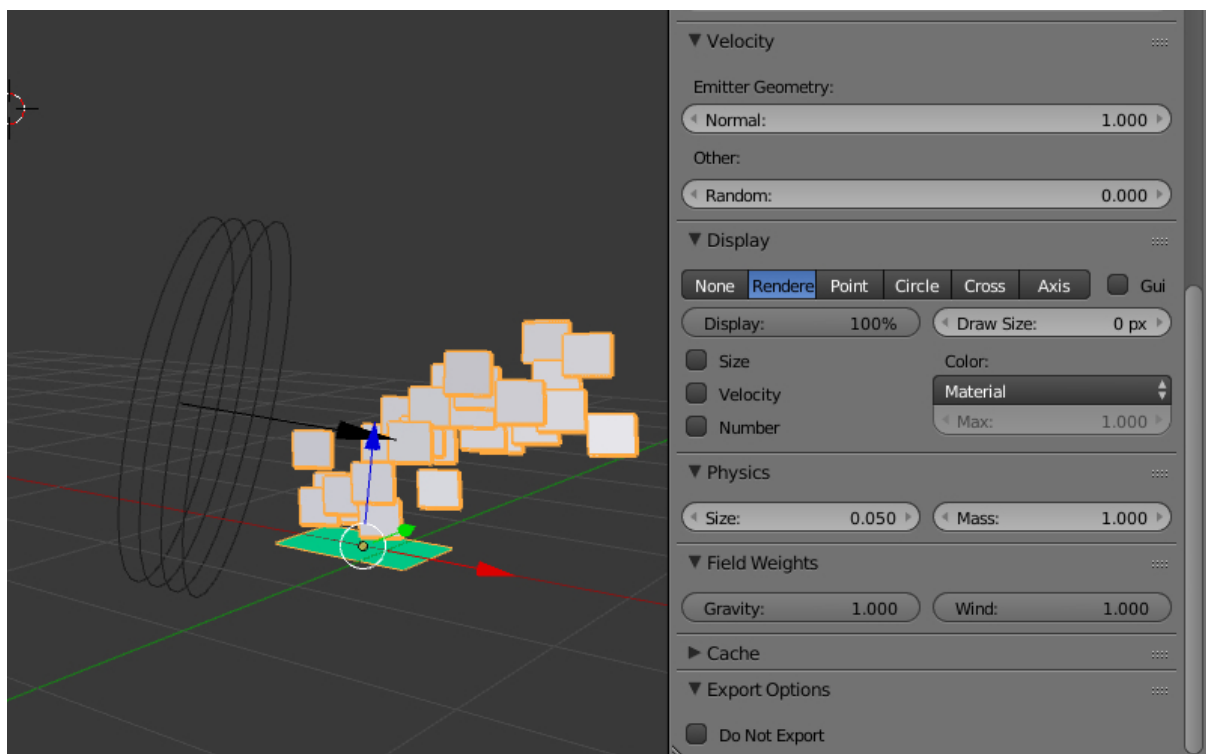

Physics > Type Physics calculation type: No, Newtonian, Keyed, Boids, Fluid. Ignored by the engine. Newtonian physics is always used. The default is Newtonian.

Physics > Size Particle size. The default value is 0.05.

Physics > Mass Particle mass. Affects interaction with force fields (such as wind). The default value is 1.0.

Physics > Forces > Brownian Exported but not used by the engine.

Rendering Settings

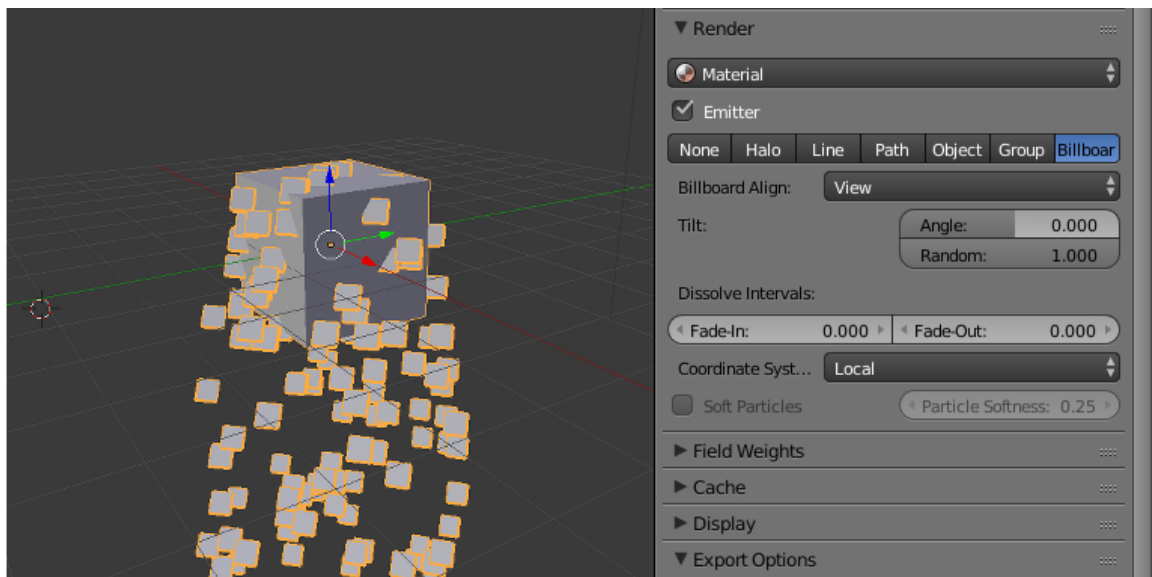

Render > Material Menu for selecting the particle's material. Used for referencing to the particle' material in case multiple materials are used by the emitter. The default value is Default Material.

Render > Emitter Enables emitter rendering on the scene. Enabled by default.

Render > Type Particle rendering mode: None, Halo, Line, Path, Object, Group, Billboard. The engine supports the Object and the Group modes which are used for objects and groups instancing respectively. Other modes are ignored. It is recommended to use the Billboard mode for convenient display of billboards. The default is Halo.

Render > Billboard Align The way billboards are oriented: View - follow the camera, XY plane, YZ plane, ZX plane - align to the corresponding plane (in the world coordinate system of Blender). The default is View.

Render > Tilt This group of parameters controls the initial tilt of the billboard planes. It consists of two parameters:

Angle Rotation angle of the billboard planes. Its value can vary from -1 to 1. The value of 1 rotates by 180 degrees (i.e. turns the billboard upside down). Set to zero by default.

Random Random variation of tilt. Its value can change from zero to 1 and is set to zero by default.

Render > Dissolve intervals > Fade-in* and Fade-out Starting and ending intervals (measured in frames) for gradually increasing and decreasing the particles' transparency.

Render > Coordinate System Coordinate system of emitting particles: Local - use local coordinate system of the emitter object, World - use world coordinate system.

Render > Soft Particles Support for soft particles, billboards of which smoothly dissolve when contacting with surfaces. Use the Particle Softness slider to tweak this effect.

Supported Settings for Force Field Influence

Field Weights > Gravity Gravity influence factor (Earth's attraction). The default value is 1.0.

Field Weights > Wind Wind influence factor. A Wind force field source should be present (can be added using Add > Force Field). A particle system is also influenced by the wind direction and strength. The default value is 1.0.

Engine Specific Settings

Export Options > Do not export Don't export.

Textures in Particle Systems

Particle systems support both standard and node materials. Supported material types are Surface and Halo. All additional settings of the Halo type materials, such as Rings, Lines and Star Tips, are also supported.

Textures of the Particle's Material

For the Surface particle's materials it is required to have a diffuse texture (normally with an alpha-channel). In the Mapping > Coordinates menu choose the UV option. Make sure that the emitter's mesh has a UV layer.

For the Halo particle's materials it is possible to use a Blend texture with a Linear gradient. In the Mapping > Coordinates menu choose the Strand / Particle option. It is required to enable Ramp on a texture.

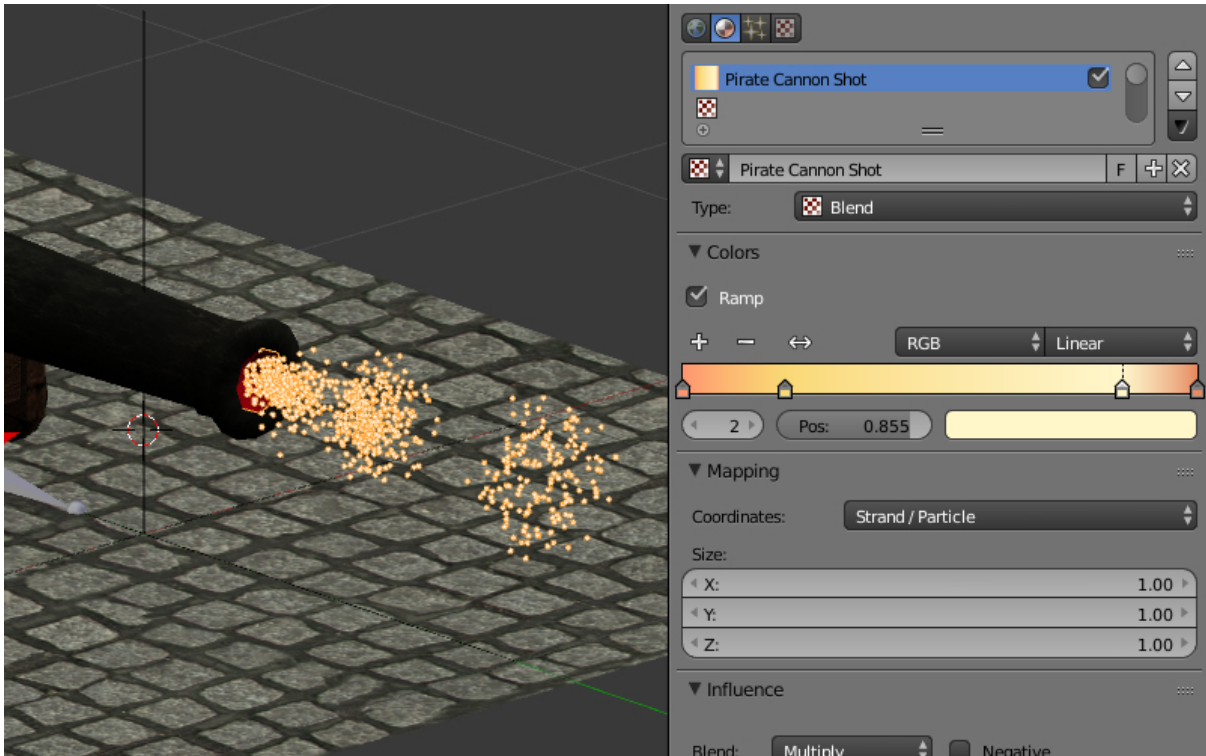

Textures of Particle Systems

Textures can also be used for setting up the behavior of particle systems. Unlike textures for particle materials such textures belong to the particle system datablock, not to the material datablock. To create a texture for the particle system it is required to go from the Particles tab to the Textures tab and then to click the New button.

The only supported type of textures is Blend with a Linear gradient. Ramp should be enabled on the texture. Up to 4 gradient control points are supported.

On the Influence panel choose the parameter which is influenced by the texture. At the moment the only supported parameter is Size.

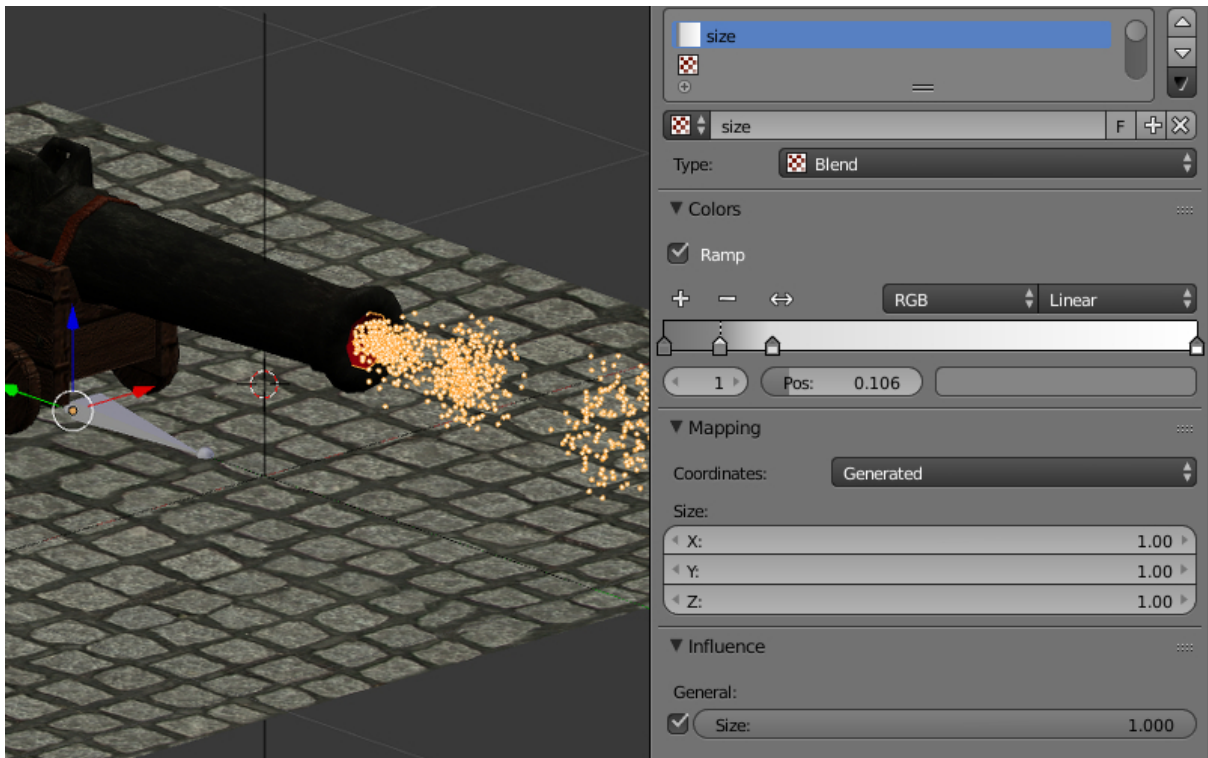

The result of using gradient textures on the particle material and the particle system:



The original model was taken from [here](#)

Particle System. Instancing

Table of Contents

- Particle System. Instancing
 - Particle System Setup
 - * Activation
 - * Display settings
 - * Dynamic grass setup
 - * Inheritance settings
 - Grass
 - Tree Leaves

A particle system can be used to create multiple object copies (so called instancing). This technique simplifies scene authoring and also reduces loading time and memory consumption as compared to the using of single objects.



Using particle systems for instancing has some limitations though:

- Movement and animation of objects inside a particle system is not allowed.
- Parenting is not possible among the objects inside a particle system, except for dupli-groups.
- Instancing of non-mesh objects is not possible.

Particle System Setup

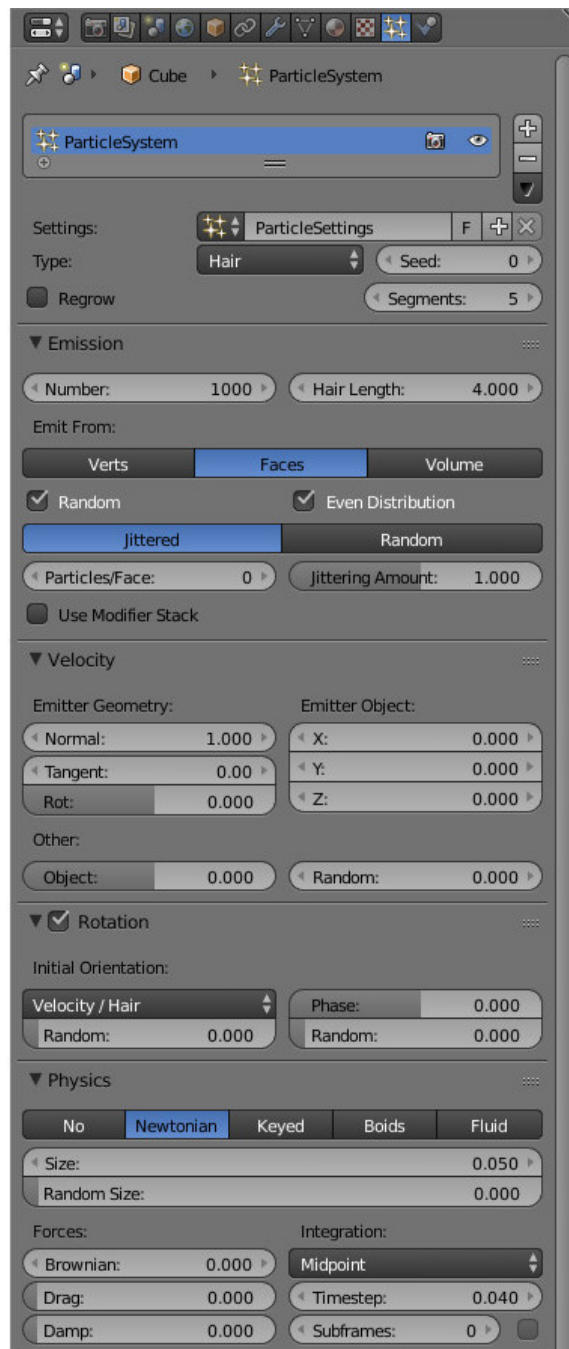

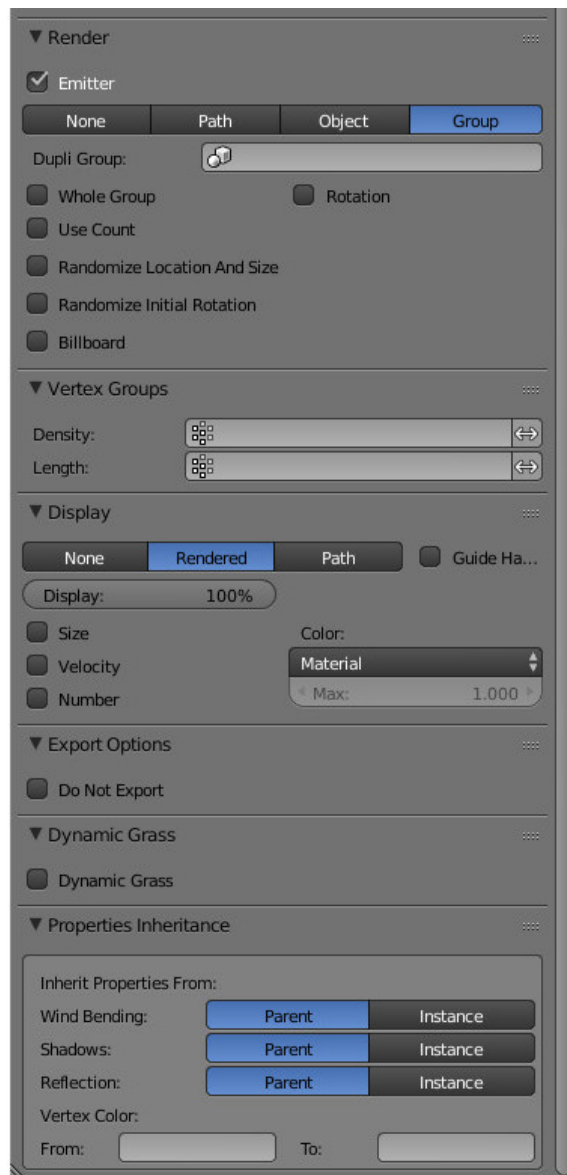

Activation

1. Create a particle system of the Hair type on the emitter.
2. On the Render panel select the Object (or the Group) rendering type.
3. In the Dupli Object field (or in the Dupli Group field) select the object (or the object group) for instancing. Both local and linked objects (or groups) are supported.

Recommended Additional Settings

1. In order to display correct sizes in the viewport, set the Emission > Hair Length and Render > Size parameters to 1.0.

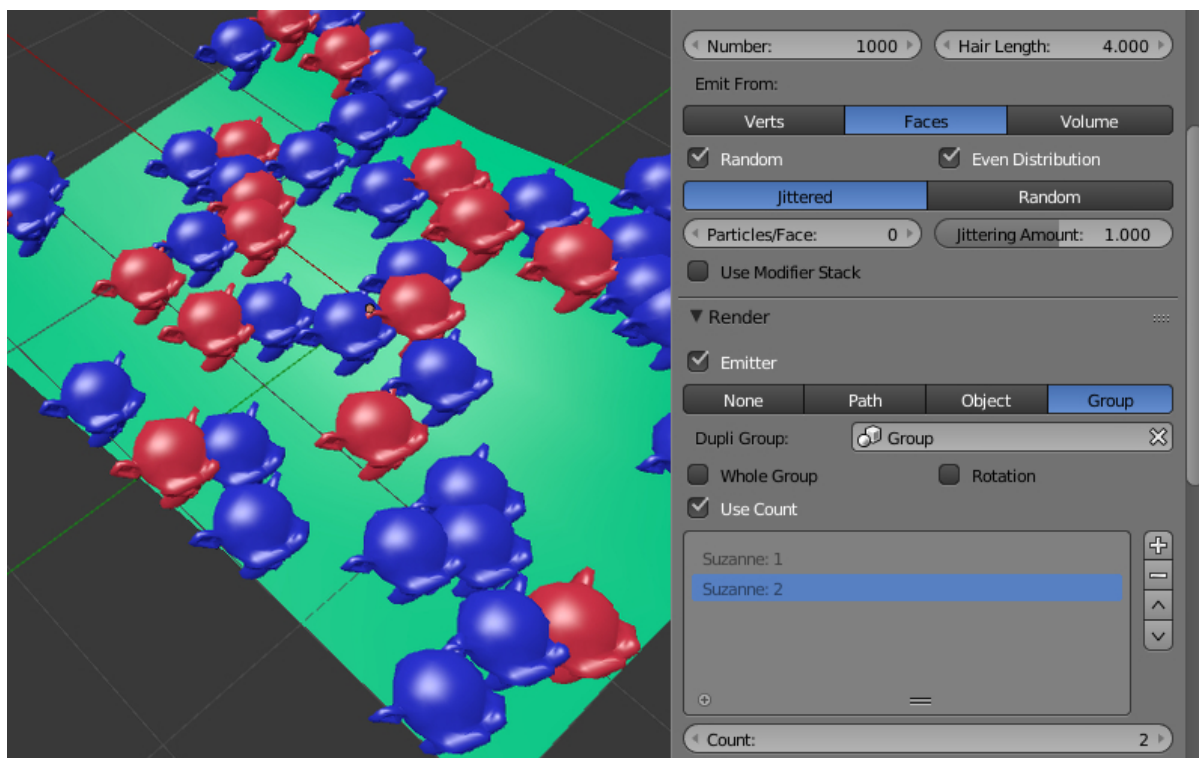

Display settings

Render > Use Count

The option is available for groups of particle objects. When enabled, the interface for setting the relative number of objects in a group becomes visible. The engine does not reproduce the exact positions of objects of certain types.

Render > Randomize Location and Size

The option enables randomization for the location and the size of the objects. If enabled, the engine generates random coordinates and size (limited to the $\pm 25\%$ range) for the particle objects. If disabled, the exact coordinates and sizes of the particle objects are exported and used.

Render > Randomize Initial Rotation

This option randomizes rotation of the objects relative to the axis defined by Rotation Type. If enabled, the engine generates random rotation angles for the particle objects. If disabled, the rotation is taken from the Rotation panel.

Render > Rotation Type

An Axis of random object rotation (the property is available when Render > Randomize Initial Rotation is enabled). There are two options:

- Z axis - the objects are turned randomly around the vertical Z axis
- Random axis - the objects are turned randomly around a random axis

The default is Z axis

Render > Rotation Strength

Coefficient which defines the range of random rotation angles - counting from the direction towards the camera. Available when the Render > Randomize Initial Rotation checkbox is enabled. Examples:

- Rotation Strength = 1 - the angles will lie within the $[-\pi, \pi]$ range
- Rotation Strength = 0.5 - the angles will lie within the $[-0.5 \cdot \pi, 0.5 \cdot \pi]$ range
- Rotation Strength = 0.1 - the angles will lie within the $[-0.1 \cdot \pi, 0.1 \cdot \pi]$ range

The default value is 1.

Render > Billboard

Enables billboarding for particles. Disabled by default.

Render > Billboard Type

Billboarding type. The option is available when the Render > Billboard option is enabled. Three types are available:

- Basic - simple one-sided billboarding: particles will be turned with their front to the observer
- Random -Random - random two-sided billboarding: particles will be more often turned with their front or rear to the observer and less often with their side; also there will be a small random turn; this model is designed specially for grass instancing
- Jittered - Jittered - one-sided billboarding with particles wavering along the plane which is turned to the observer; this model is designed specially for instancing of tree leaves

The default is Basic.

Render > Jitter Amplitude

Coefficient which defines the particle oscillation amplitude. Available when the Jittered type is selected from the Render > Billboard Type menu. The bigger this parameter is, the bigger is the oscillation amplitude. The default value is 0.

Render > Jitter Frequency

Particle oscillation frequency in hertz. Available when the Jittered type is selected from the Render > Billboard Type menu. The default value is 0.

Render > Billboard Geometry

Billboard rotation type (the option is available when the Render > Billboard checkbox is set). Two types are available:

- Spherical - spherical billboarding i.e. particles are fully oriented to the observer and their rotation is unlimited;
- Cylindrical - cylindrical billboarding i.e. particles are rotating only around the vertical Z axis;

The default is Spherical.

Dynamic grass setup

Dynamic Grass

The option enables the dynamic grass rendering mode. Disabled by default.

Dynamic Grass > Scale Threshold

Minimum size for dynamic grass particles. Smaller particles will not be rendered. The option is available if Dynamic Grass is enabled.

Inheritance settings

Properties Inheritance > Wind Bending

Inheriting the Wind Bending settings by the particles:

- Parent - inherited from the emitter
- Instance - inherited from the particle object itself

The default is Parent.

Properties Inheritance > Shadows

Inheriting the shadow settings by particles:

- Parent - inherited from the emitter
- Instance - inherited from the particle object itself

The default is Parent.

Properties Inheritance > Reflection

Inheriting the reflection settings by particles:

- Parent - inherited from the emitter
- Instance - inherited from the particle object itself

The default is Parent.

Properties Inheritance > Vertex Color

Inheriting the vertex color from the emitter. Contains two fields:

- From - the emitter's existing vertex color name
- To - the particle's existing vertex color name

There is no inheritance by default.

Grass

Instancing of objects can be used for visualizing vast grass. In this case grass is rendered near the camera when it moves through the landscape.

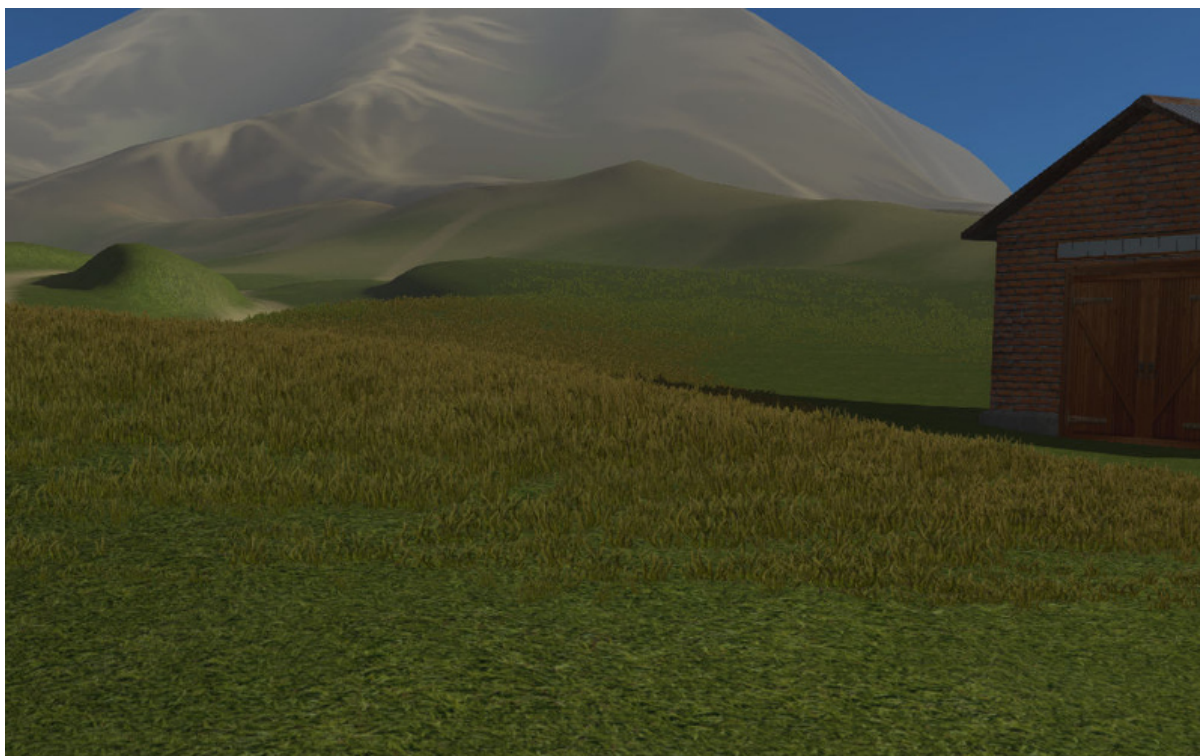

Activation

1. On a separate plane object create a particle system for object instancing. Enable the Dynamic Grass option.
2. Enable the Terrain Dynamic Grass option for the supposed landscape material.

Setup

It is recommended to create a few planes (for example 3) with sizes corresponding to the desired grass cascades (e.g. 100, 150 and 250 meters).

For the landscape's material, the following text fields become active when the Terrain Dynamic Grass option is enabled:

Dynamic Grass Size (R) Vertex color layer name of the landscape mesh which is intended for modifying the grass size. The size (i.e. height) of the grass is defined by gray tints - the brighter color the is the higher is the grass.

Dynamic Grass Color (RGB) Name of the landscape mesh's vertex color layer which is intended for grass tinting. The vertex color is multiplied by the grass material color. The Influence > Blend parameter for the grass material's diffuse texture should have the Multiply value.

Vertex color layers with such names should exist in the landscape mesh.

It is also recommended to disable rendering of the emitter (the Render > Emitter option).

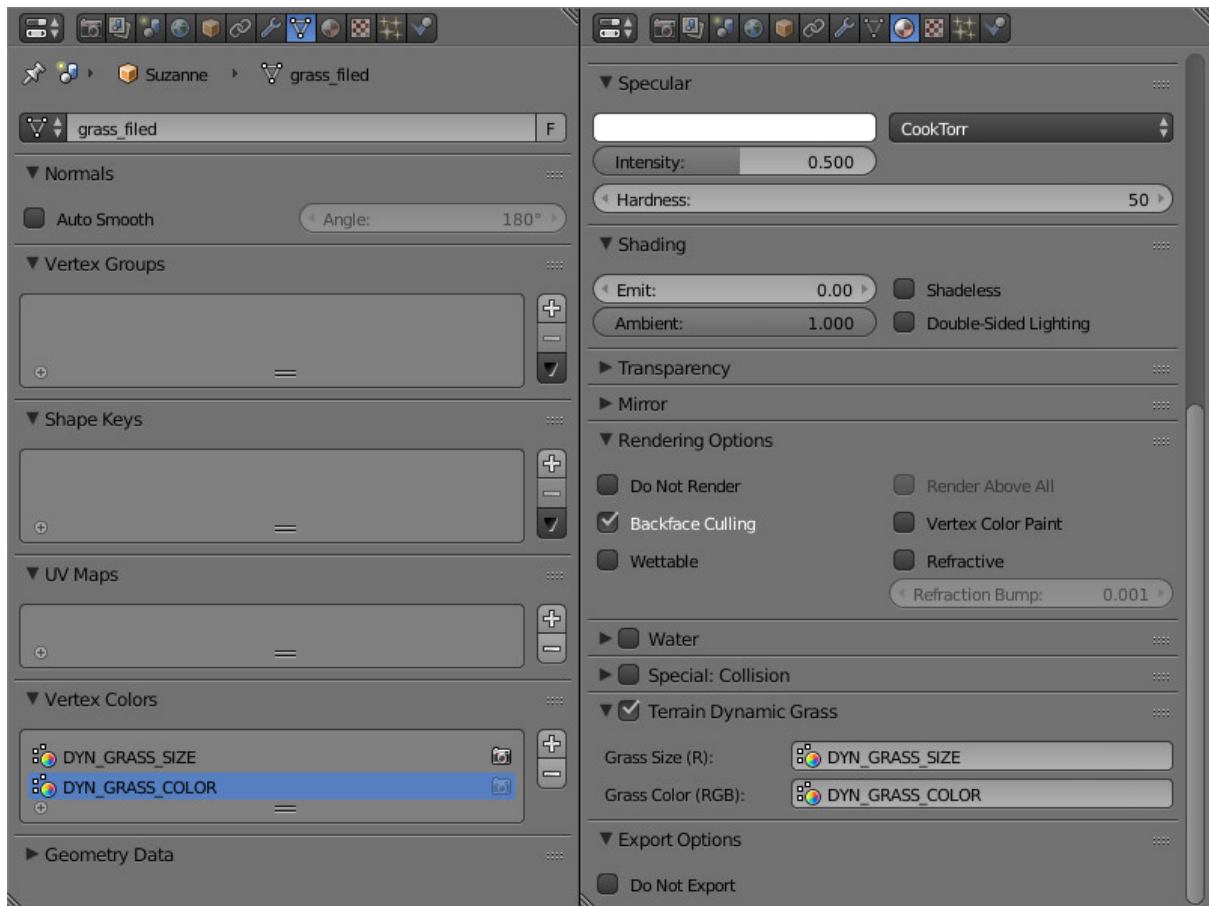

Tree Leaves

Instancing suits the rendering of tree leaves well and allows to get a better level of detail.



Activation

Performed as described in the Particle system setup -> Activation section (see above). In this case the tree is the emitter and the leaves and the small branches are the particles.

Additionally, the following operations can be performed for the emitter:

- create a vertex group which includes vertices on which the particles will be placed
- create a vertex color layer for the wind bending parameters of the tree and the leaves
- create a vertex color layer to be inherited by the particles (for example it can be used for tinting the particles)

Setup

1. Random rotation settings

If the Initial Random Rotation checkbox is enabled, it is recommended to select the vertical axis for random rotation - Z axis (by using the Rotation Type menu). The Rotation Strength value can be set at will.

2. Billboarding settings

It is recommended to enable billboarding, to set its type as Jittered (by using the Render > Billboard Type menu) and to make it spherical - Spherical (by using the Render

> Billboard Geometry menu). The Render > Jitter Amplitude and Render > Jitter Frequency values can be set at will.

3. Particle position settings

It is recommended to select the Verts value from the Emission > Emit From menu, and to select the emitter's vertex group (in the Vertex Group > Density field) which defines the positions of particles. Note, that the Render > Randomize Location and Size checkbox should be disabled.

4. Wind effect settings

It is recommended to enable inheritance settings from the emitter - select the Parent in the Properties Inheritance > Wind Bending menu. Then for the emitter on the Object panel enable the Wind Bending checkbox and set up the bending parameters. For a tree, it is enough to specify the Wind Bending > Main Bending > Angle and Wind Bending > Main Bending > Frequency parameters and also a vertex color name for bending in the Wind Bending > Main Bending > Main Stiffness field.

5. Vertex color inheritance settings

For the emitter's vertex color to be inherited by the particles, it is required to specify both the emitter's vertex color name and the particle's vertex color name in the Properties Inheritance > Vertex Color > From and Properties Inheritance > Vertex Color > To fields respectively. As a result, the color of the emitter's vertex that is closest to the particle (specified in the From field) will be copied and propagated into the particle's To vertex color layer.

The resulting vertex color layer with the name specified in the Properties Inheritance > Vertex Color > To field can be used in the particle's node material for its tinting and for any other effects.

6. Setting up the size of particles via vertex group weights

In order to create dependency between the size of particles and vertex group weights, select the name of the desired vertex group in the Vertex groups > Length field.

The influence can be tweaked by setting weights in the selected vertex group.

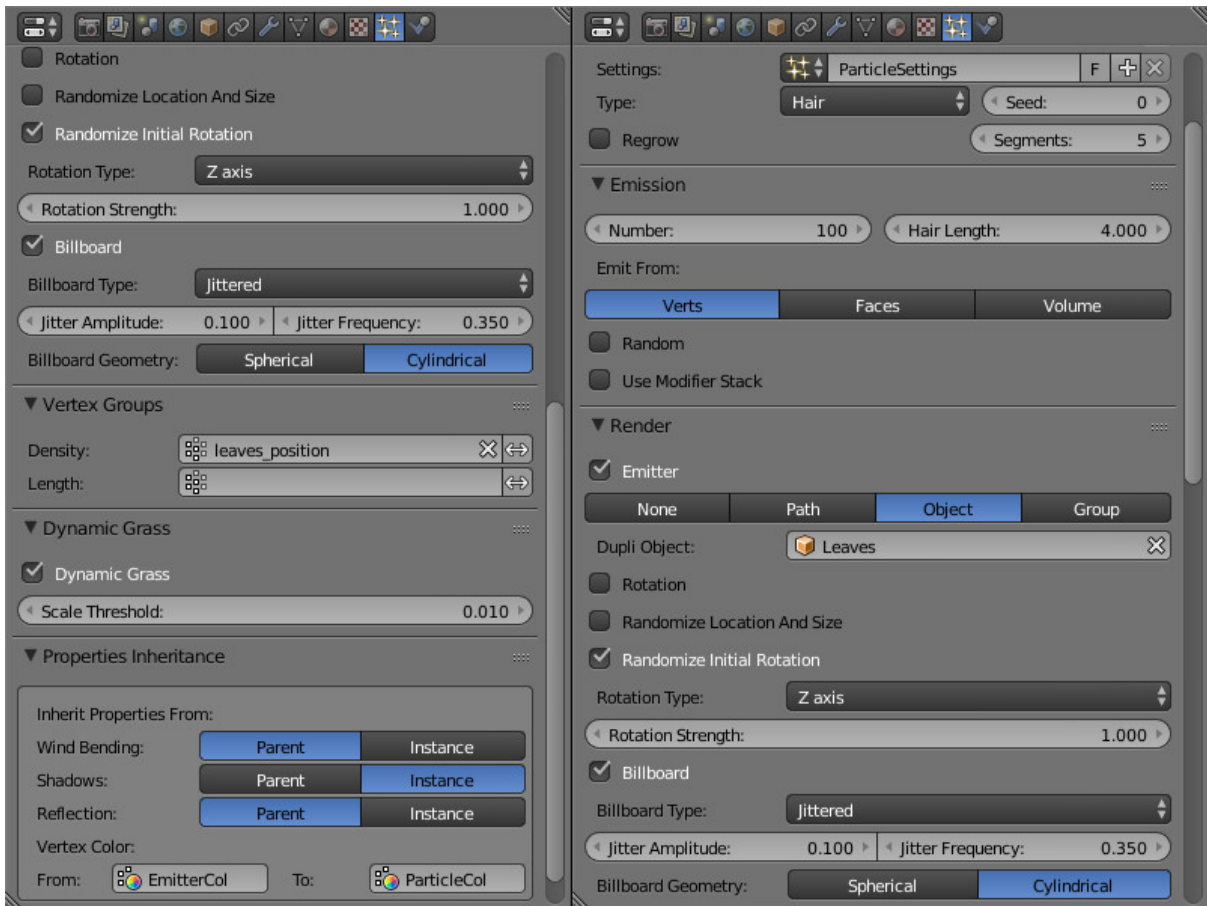

Animation

Table of Content

- Animation
 - Animation Control
 - Object Animation
 - Skinning and Skeletal Animation
 - * Baking parameters
 - * Animation Blending
 - Vertex Animation
 - * Baking parameters
 - Default Animation
 - Non-Linear Animation
 - * NLA Editor
 - * Controlling via API
 - Audio Source Parametrization
 - Animation of Value and RGB Nodes

In general animation is changing the object's parameters in time. The engine supports the following types of animation:

- Object animation means the transformation of an object as a whole.
- Skeletal Animation, i.e. object deformation using bones. Animation of a standalone armature object is also supported (for parenting to bones).
- Vertex animation. An object's deformations can be recorded as frames and then reproduced in the engine.
- Audio sources parametrization. Speaker's Volume and Pitch can be animated.
- Animation of the Value node output in node materials.
- Wind bending - a procedural animation. Described [separately](#).
- Particle emission. Described in the [corresponding section](#).

Animation Control

There are two ways to control animation in the engine:

1. Automatically, activating the Animation panel and choosing the Behavior parameter in the object's properties. In this case an appropriate animation method will be chosen by the engine and the object's animation playback will start just after a scene is loaded. In case of skeletal animation the action which is assigned to the object in the Action Editor window is played by default.
2. In an application via API using the animation module methods.

It's useful to use the Animation interface for tweaking animation. This is covered in the corresponding section.

Object Animation

The parameters that can be animated are the center coordinates (Location), Rotation and Scale.



Animation keyframes can be added for an object motion in Blender and then reproduced in the engine.

The following keyframe types are supported:

- Location
- Rotation – the Quaternion(WXYZ) or XYZ Euler mode is required.
- Scale – for correct results the scale factor should be the same along all 3 axes.
- LocRot – a combination of Location and Rotation.
- LocScale – a combination of Location and Scale.
- LocRotScale – a combination of Location, Rotation and Scale.
- RotScale – a combination of Rotation and Scale.

If a mesh object is animated it is required to activate the Force Dynamic Object option on the Rendering Properties panel under the object properties tab.

Skinning and Skeletal Animation



For skeletal animation both a mesh object and an armature object are needed. The four steps should be carried out:

1. Create the object's "skeleton" in the armature object.
2. Assign vertex groups in the mesh object and link them to the bones. This can be performed by weight painting for example.
3. Animate the bones in the pose mode of the armature object. The same keyframe types can be used as for the object animation.
4. When inverse kinematics (IK) or other nontrivial structures are used, an additional step is required to bake the animations (Action datablocks in Blender). Baking can be performed using the Bake Skeletal Animation interface located on the Blend4Web:

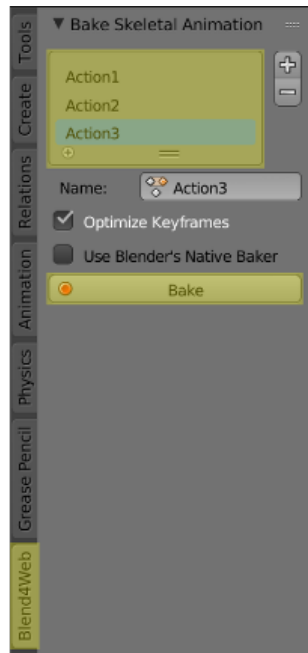

Baking parameters

Baking is performed with the armature object selected.

The actors that will be baked are listed in the window with the list of actors. If the list is empty, all available actors will be baked.

Name The current action name from the list of actions being baked.

Optimize Keyframes Optimize the animation keyframes after baking. In case of incorrect results it's recommended to turn this option off.

Use Blender's Native Baker Use Blender's animation baker (the Bake Action option) instead of Blend4Web's. Blender animation baker's settings differ from Blend4Web's.

Bake Perform baking. If the process is completed successfully, actions with names of B4W_BAKED_ACTOR_NAME type appear in the scene. These actions can be assigned to the armature object and played back in the engine. It's worth noting that appropriate functioning of such actions in Blender is not guaranteed.

Note: The engine supports up to 4 vertex groups per vertex. If the number of vertex groups exceeds 4, the vertex groups with the most influence are selected. When the scene is loaded, the vertex weights are normalized i.e. their sum is reduced to 1.

To remove vertex groups which are not used by armature, use button Remove Clean Unused Vertex Groups.

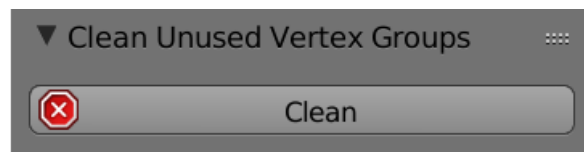

Blend4Web also has initial support of the armature constraints. For now, only several types of constraints are supported, including Copy Transforms, which can be used to attach an armature to an object, producing effects such as ragdoll. Support of the other types of constraints will be added in further releases.

The full list of supported constraints and their descriptions can be found in a [dedicated section](#).

Animation Blending

The engine also supports animation blending. To use this feature, the Animation Blending (located on the Animation panel of the Object tab) property should be enabled.

Warning: No more than two animations can be blended simultaneously.

To blend animations, you have to allow two animation slots to blend first:

```
var m_animation = require("animation");

var m_scenes = require("scenes");

...

var armobj = m_scenes.get_object_by_name("My_Armature");

...

m_animation.set_skeletal_slots(armobj, slot_1, slot_2, 0.5);
```

Vertex Animation

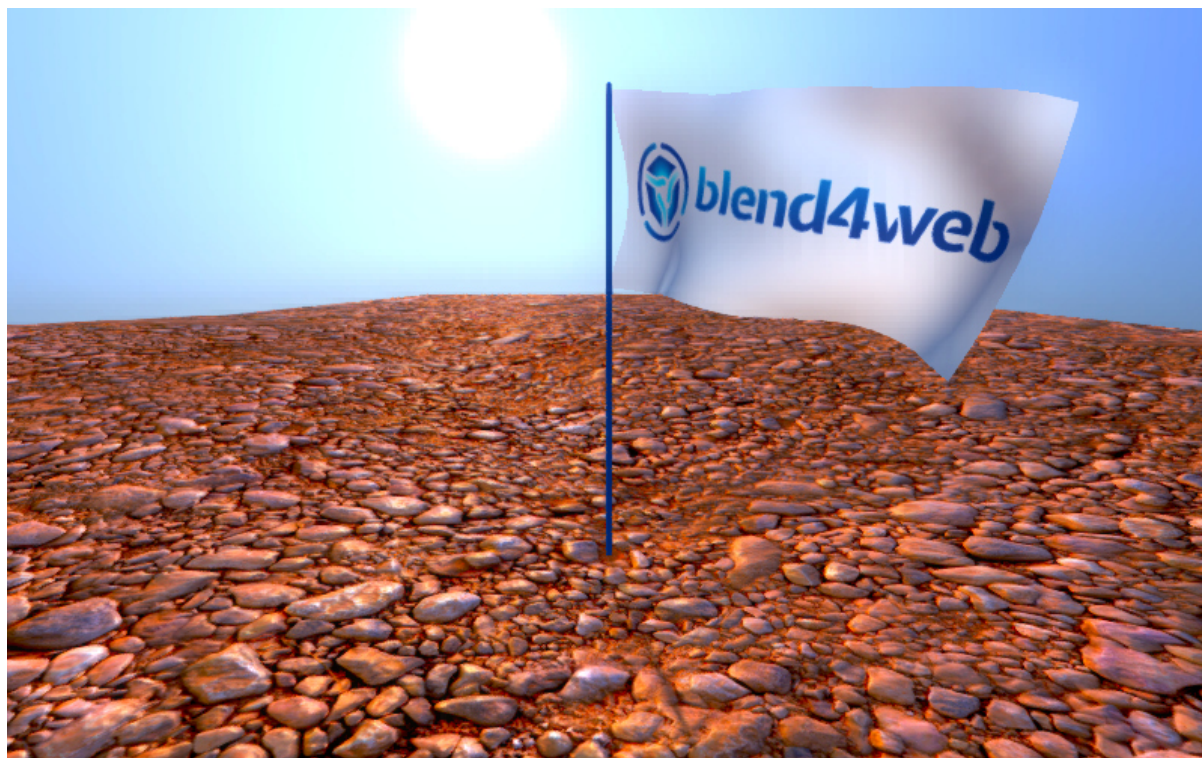

Allows to record any geometry changes of a mesh object. Note that every vertex animation frame counts as a mesh. It's not recommended to make a long animation for a high-poly mesh, as it can increase the size of the source and exported files significantly and can also slow down the work of the engine. A special tool is used for baking vertex animation - Bake Vertex Animation - located on the Blend4Web tools panel.

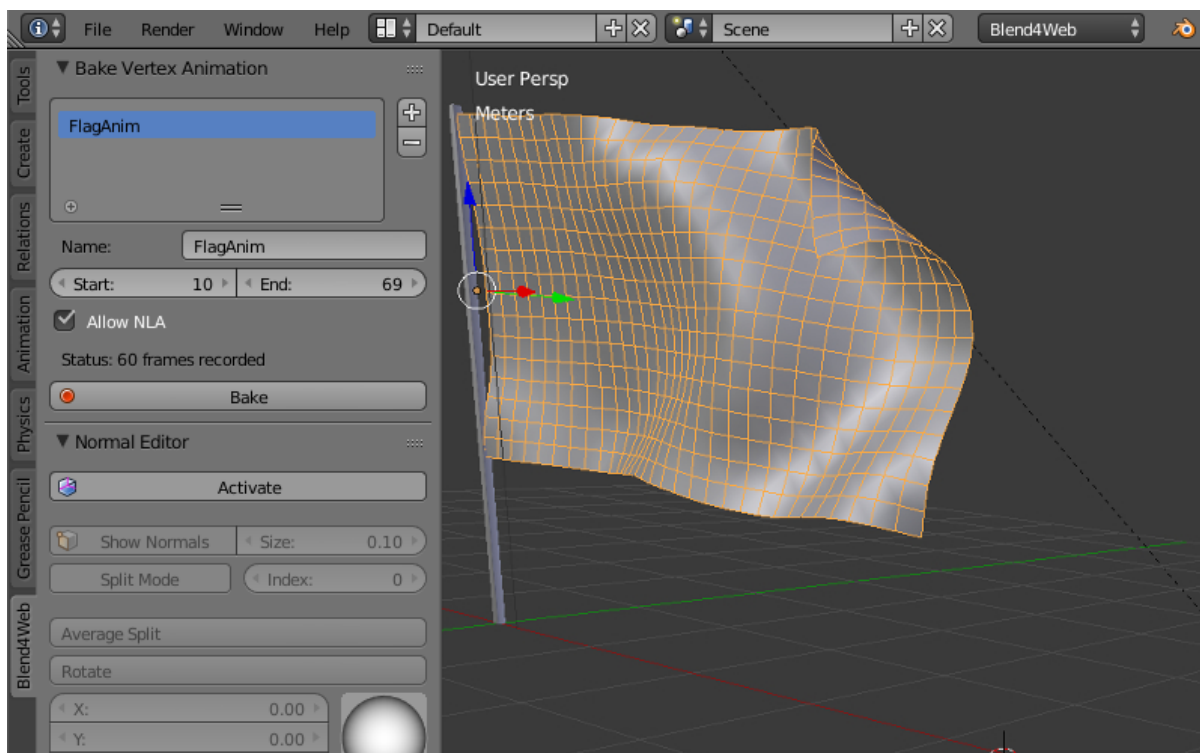

Baking parameters

Name The name that will be assigned to the baked animation.

Start The baking will start from this frame.

End The baking will end at this frame.

Allow NLA Allows using [NLA](#) to control the baked animation.

Status In this string, the number of frames of the baked animation is shown. If the baking hasn't been performed yet, the word `Empty` is shown instead.

Bake The animation baking is performed by pressing this button.

Note: For vertex animation to work correctly, the `Export Vertex Animation` parameter (`Export Options` section of the `Object` panel) of the selected object should be enabled.

Default Animation

Blend4Web also has an option to automatically play object's animation. To do it, you need to enable the `Apply Default Animation` parameter in the `Animation` section of the `Object` panel of an object you want to animate. Skeletal and object animation types are supported.

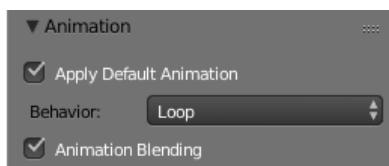

Animation starts to play right after the application startup and plays very similar to the [Play Timeline](#) node, only without an option to set up the start and end markers (instead, it always starts from the first frame of the timeline and ends with the last). You can also set up animation behavior, like in the [Play Animation](#) node.

Animation Blending This option is only available for Armature type objects. It should be enabled if you want to blend skeletal animations.

Blending animations is described in a [dedicated section](#).

Non-Linear Animation

NLA Editor

The Blender's non-linear editor lets us set the scene's behavior in a comfortable way. With its help we can implement simple scenarios. This way coding is not needed for simple scenes and applications.



The engine supports controlling the following entities:

- Any animation the parameters of which can be presented with Actions
- Audio playback
- Particles emission (in the form of a connection with the global timeline)



Usage

1. Activate the NLA panel under the Scene tab.
2. In the NLA Editor set up the required behavior for the scene.
3. Choose the animation time interval on the Timeline panel.

Additional settings

The NLA > Cyclic NLA scene setting activates the cyclic NLA animation mode.

Note: In order to use vertex animation, enable “Allow NLA” option on the [vertex animation panel](#).

Limitations

- A simultaneous playback of different types of animation for the same object is not supported.

Controlling via API

Non-linear animation playback can be controlled via API methods of the `nla.js` module.

```
// ...
var m_nla = require("nla");
// ...
m_nla.set_frame(150);
// ...
var frame = m_nla.get_frame();
// ...
m_nla.play();
// ...
m_nla.stop();
// ...
```

Please note, that if the [Logic Editor](#) is used, the `set_frame`, `play`, `stop` methods are not available.

Audio Source Parametrization

In addition the following animation key types are supported for the speaker objects:

- Volume
- Pitch

Audio sources parametrization in essence follows object animation.

Animation of Value and RGB Nodes

Playback of keyframes inserted on Value and RGB nodes is supported in node materials.

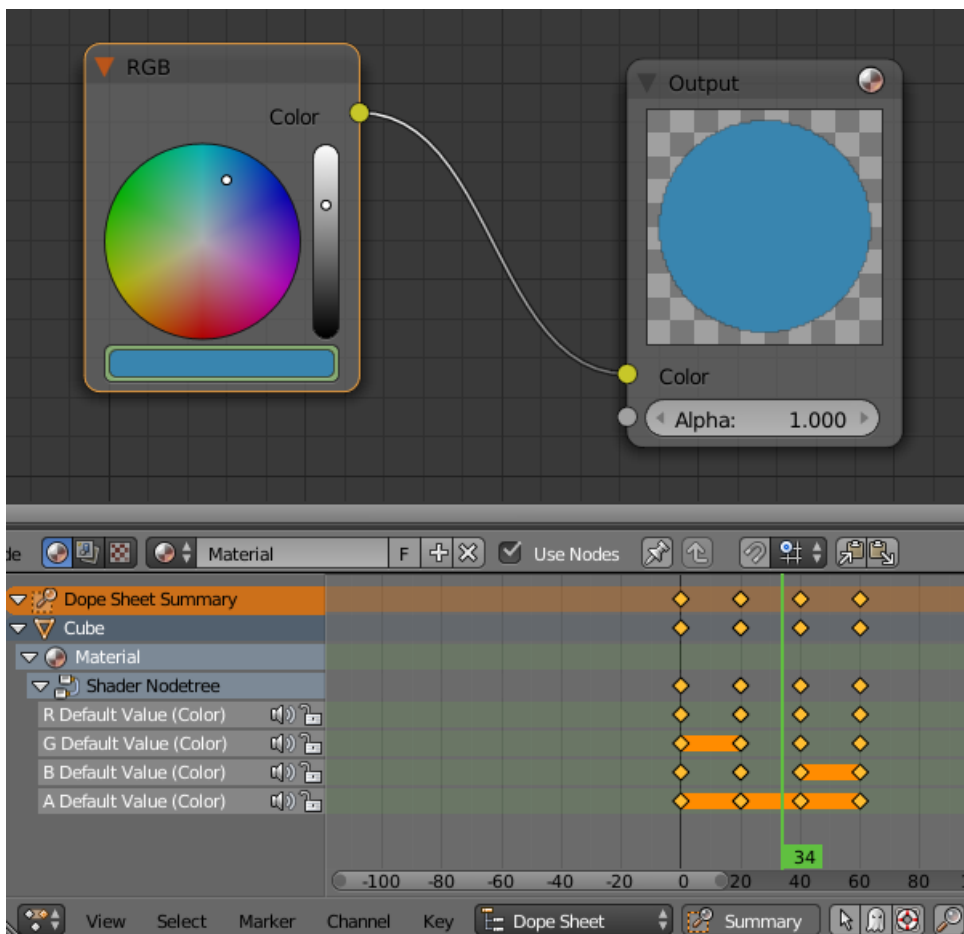
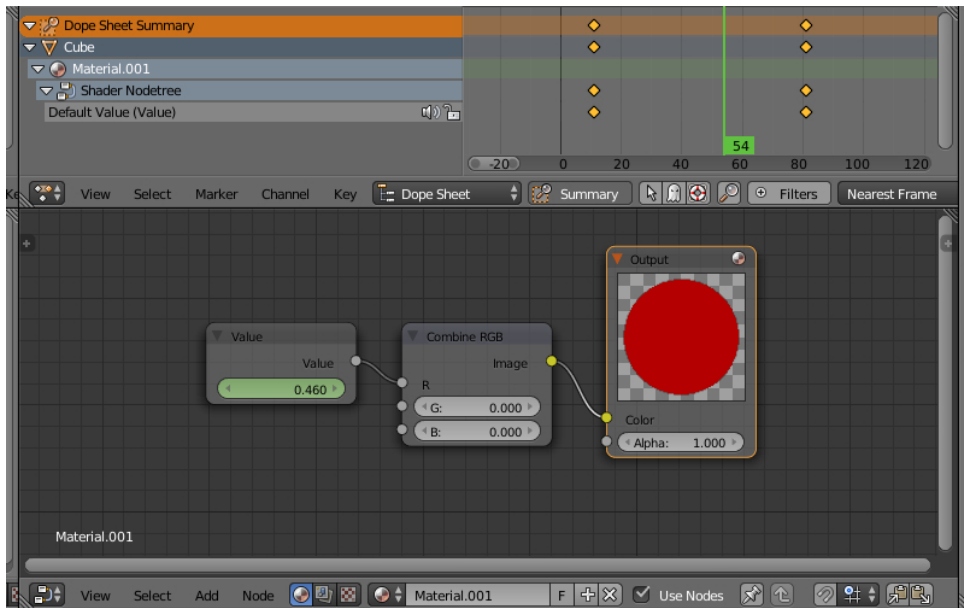

Note: Animation of numerical and color values on other nodes is not supported.

Can be also used to create tracks in the [non-linear animation editor](#). Multiple animated Value or RGB nodes are supported per single material. Values of these nodes can be also modified via API, by using the `set_nodemat_value` and `set_nodemat_rgb` methods of the objects module.

See also:

[Time \(B4W_TIME\)](#)

Outdoor Effects

Table of Contents

- Outdoor Effects
 - Water
 - * Activation
 - * Basic Settings
 - * Waves Dynamics
 - * Surface Wetting
 - * Reflection and Fresnel Effect
 - * Shoreline Smoothing
 - * Color Gradient
 - * Refraction
 - * Foam
 - * Caustics and Chromatic Aberration
 - * Underwater Environment
 - * Volumetric Waves
 - * Settings for Surface Generation
 - Atmosphere
 - * Scattering
 - * Fog
 - * Time of Day
 - * Stars
 - Lens Flare
 - * Lens Flare Settings
 - * Lens Flare Object
 - Wind
 - * Activation
 - * Setting up
 - * Animation of Grass and Tree Leaves

Blend4Web has several environmental effects that can be useful for creating outdoor scenes.

Water

Activation

For the supposed water material activate the Water panel option under the Material tab.



Basic Settings

Transparency It is recommended to enable the gradient transparency (set the Transparency > Type parameter to the Alpha Blend value) and to tweak the Alpha value.

Lighting parameters Lighting parameters for the water material can be set up as described in the [Lighting Parameters](#) section.

Waves Dynamics

Ripples on the water are simulated by normal maps with animated UVs (from 0 up to 4 pieces). For normal map the only shared image is used - the textures differs only by the Mapping > Size parameters. The water mesh must have a UV layer.

Surface Wetting

Is carried out automatically. To turn the effect on activate the `Wettable` option on the needed materials `Rendering Options` panel.

Reflection and Fresnel Effect

For the water material both static and dynamic reflection is supported as well as the Fresnel effect. See the [Reflection](#) section.



Shoreline Smoothing

The effect affects the water near the shoreline - it becomes more transparent.

Water > Shore Smoothing Enable smoothing.

Water > Absorb Factor This is the light absorption coefficient for water. The higher it is the more transparent the water is. This value can vary from 0 to 100. The default value is 6.

Color Gradient

For color gradient the water material must have a texture with the Export Options > Shore Distance Map option enabled. This texture can be generated using the script for baking shoreline parameters.

Shallow Water > Color This sets the color of shallow water. By default, blue (0.008, 0.222, 0.8) is used.

Shallow Water > Factor This sets the mixing factor for the color of shallow water. This value can vary from 0 to 2, and is set to 1 by default.

Shore Water > Color This determines the color of the water just at the shore line. By default, dark blue (0.003, 0.19, 0.57) is used.

Shore Water > Factor This sets the mixing factor for the color of the water just near the shoreline. This value can vary from 0 to 2, and is set to 0.5 by default.

Refraction

Under the Render tab in the Reflections and Refractions panel set the Refractions option to ON or AUTO.



Foam

Activation

For creating foam add a diffuse texture into the water material slot. Every RGB channel of this image must contain a BW foam texture in it. Then enable the Water Foam panel.

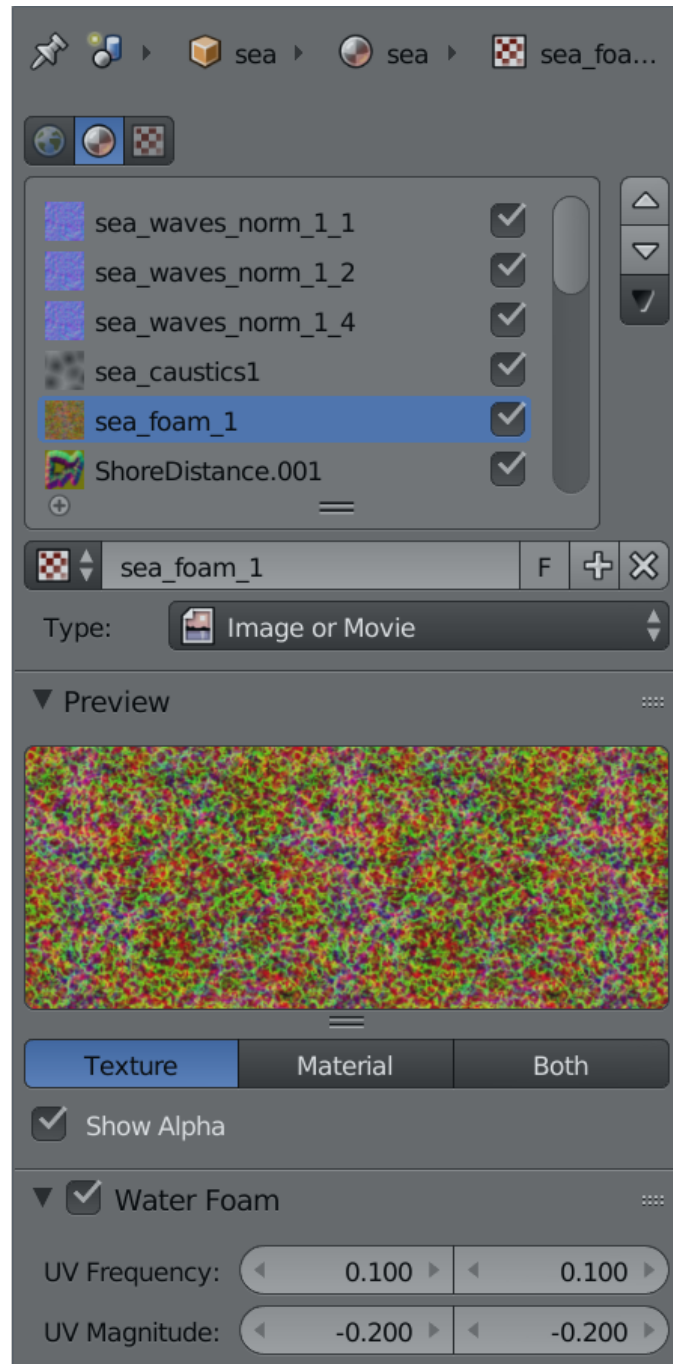

Setting up the Textures

Water Foam > UV Frequency Oscillation frequency of the animated UV coordinates.
The default value is (1.0, 1.0).

Water Foam > UV Magnitude Oscillation amplitude of the animated UV coordinates.
The default value is (1.0, 1.0).

Setting up the Material

Foam > Factor General influence factor for the foam. The default value is 0.5.

Caustics and Chromatic Aberration

To create the caustics effect turn on the Caustics option on the water material. Also, there has to be at least one Sun on the scene.



Scale Cell size for the procedural texture. The default value is 0.25.

Brightness Caustics influence factor. The default value is 0.5.

Underwater Environment

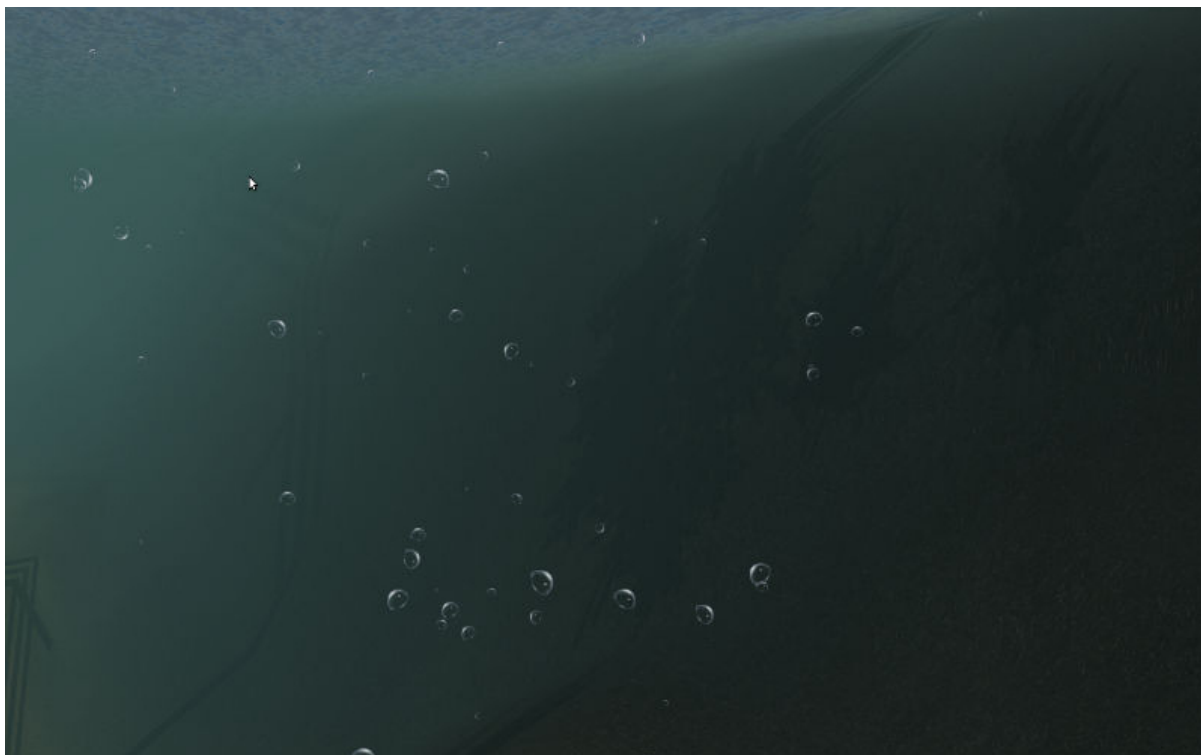

Visibility Settings (“fog”)

Underwater Fog > Color Fog color. The default value is (0.4, 0.6, 0.7).

Underwater Fog > Density Exponential factor which affects the density and visibility distance. The default value is 0.06.

The [god rays](#) effect settings are also applied.

Note: The Rendering Options > Backface Culling option must be turned off for the correct water surface rendering.



Volumetric Waves

Activation

To enable procedural waves the Waves option must be turned on.

Note: The direction of procedural waves is derived from a Wind force field in the scene. If a scene does not have a Wind force field, procedural waves will only move in the default direction which cannot be changed.



Setting up

Wave Height Wave height can vary from 0 to 5. The default value is 1.0.

Wave Length Wave length can vary from 0.01 to 200. The default value is 10.0.

Noise Dist Scale 0 This is the size of the first component of the open water waves. This parameter can vary from 0 to 1. Default value is 0.05.

Noise Dist Scale 1 This is the size of the second component of the open water waves. This parameter can vary from 0 to 1. Default value is 0.03.

Noise Dist Freq 0 This sets the frequency of the first component of the open water waves. This parameter can vary from 0 to 10. Default value is 1.3.

Noise Dist Freq 1 This sets the frequency of the second component of the open water waves. This parameter can vary from 0 to 10 and is set to 1 by default.

Min Dir Shore Fac This is the minimum height decrease coefficient of the shore waves. This parameter can vary from 0 to 1 and is set to 0.4 by default.

Dir Frequency This sets the frequency of the rolling of the shore waves. This parameter can vary from 0 to 10 and is set to 0.5 by default.

Noise Dir Scale This specifies the size of the noise for the shore waves. This parameter can vary from 0 to 1 and is set to 0.05 by default.

Noise Dir Freq This describes the frequency of the noise for the shore waves. This parameter can vary from 0 to 1. Default value is 0.07.

Min Dir Noise Fac This is the noise minimum for the shore waves. This parameter can vary from 0 to 1. Default value is 0.5.

Min Dist Fac This sets the minimum coefficient of mixing open water waves. This parameter can vary from 0 to 1. Default value is 0.2.

Horizontal Factor This coefficient shows how much the shore waves are shifted in the direction of the shoreline. This parameter can vary from 0 to 10. Default value is 5.

Settings for Surface Generation

Generate Mesh This enables a generated surface.

Cascades Number This describes the number of cascades on the generated surface. This parameter's value can vary from 1 to 20. Default value is 5.

Subdivisions This is the number of subdivisions in generated mesh. Default value is 64. The lowest possible value for this parameter is 2, while the highest possible value is 512.

Detailed Distance This specifies the maximum distance from the camera to the edge of the last cascade. The value of this parameter can vary from 1 to 5000. Default value is 1000.

Baking Shoreline Data to Texture

On the tools panel (hotkey "T") under the Blend4Web tab open the Bake Shore Distance Map panel. Set the parameters: maximum distance to shore (Maximum Distance) and the resulting texture size (Texture Size). Select a landscape object (or multiple objects) first, and then - a water object. Click the Bake button.

Depending on the texture size and the number of vertices in the processed meshes the execution time of the script may vary from a fraction of a second up to several minutes. Make sure that the texture named ShoreDistance is created for the water mesh.

Upon script execution some system properties are saved in the water material. Therefore, the scene must be saved after the script has finished working.

Atmosphere

Scattering

Enable World > Render Sky, then activate Procedural Sky panel under the World tab. Please note, that if a [static skydome texture](#) is being used at the same time, it will be replaced.

Note: Also, a procedural sky texture can be used to imitate scattered [environment lighting](#) similar to the [static skydome texture](#). To do this, enable the Procedural Sky >

Use as Environment Lighting and Environment Lighting > Sky Texture options. If the world texture for environment lighting already exists, it will be replaced.

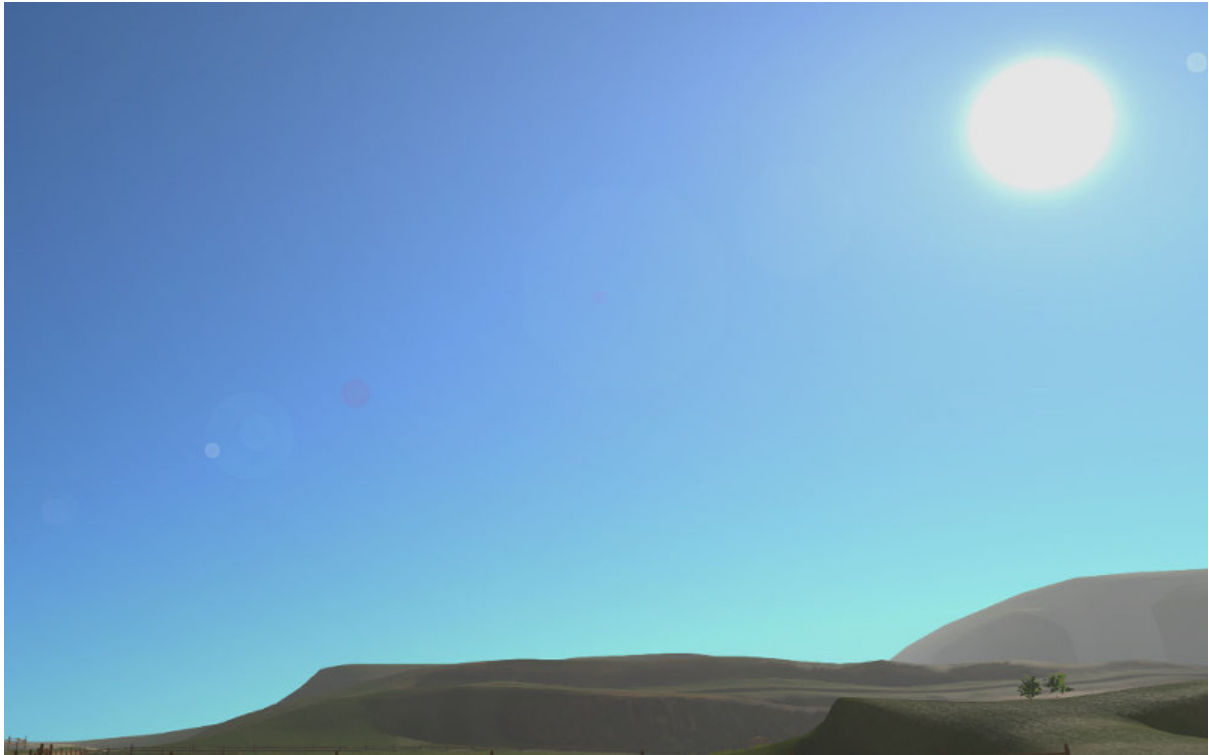

Supported settings:

Procedural Sky > Sky Color Base sky color. The default value is (0.087, 0.255, 0.6) (blue).

Procedural Sky > Rayleigh Brightness Rayleigh scattering brightness (i.e. scattering on small particles). The default value is 3.3.

Procedural Sky > Mie Brightness Mie scattering brightness (i.e. scattering on large particles). The default value is 0.1.

Procedural Sky > Spot Brightness Sun spot brightness. The default value is 20.0.

Procedural Sky > Scatter Strength Light scattering factor. The default value is 0.2.

Procedural Sky > Rayleigh Strength Rayleigh scattering factor. The default value is 0.2.

Procedural Sky > Mie Strength Mie scattering factor. The default value is 0.006.

Procedural Sky > Rayleigh Collection Power Rayleigh scattering exponent. The default value is 0.35.

Procedural Sky > Mie Collection Power Mie scattering exponent. The default value is 0.5.

Procedural Sky > Mie Distribution Mie scattering distribution. The default value is 0.4.

Fog

The engine supports standard parameters located on the World > Mist panel. Besides this, overriding fog color is possible.

Fog settings are described in the [Scene Settings](#) chapter.

When a dynamic skydome is used, the fog color is defined by the sky color.

Time of Day

Enable the Dynamic Intensity options for the lamp.

Time of day can be set by applications via API. Particularly time of day can be set using the Lighting interface of the [Scene viewer](#).

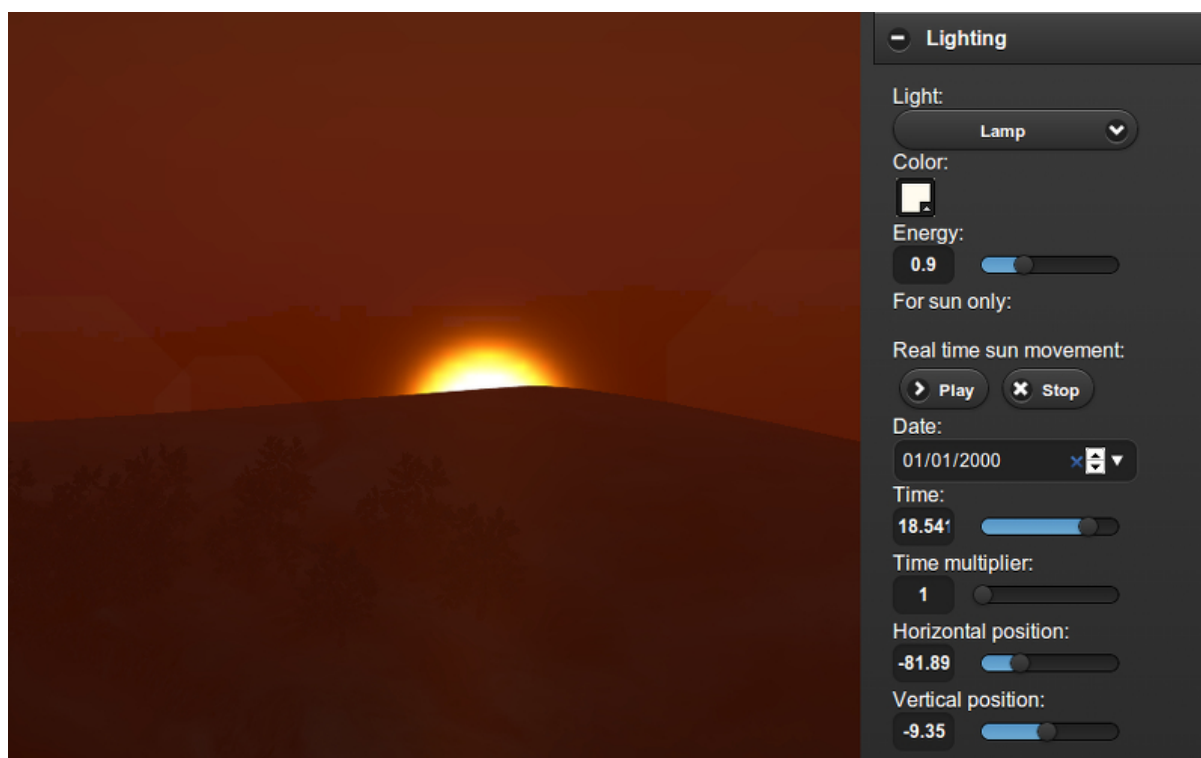

Stars

Stars setup is described in the [Halo Materials](#) section.



Lens Flare



This feature can be enabled by the Lens Flare check-box located in the Rendering Options of the Material panel.

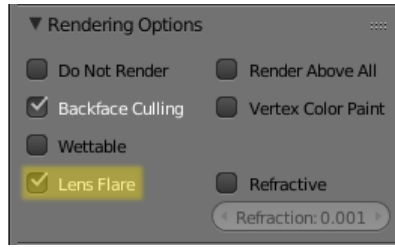

Note: This effect is strongly recommended to use with a single Sun type light source present in the scene.

Lens Flare Settings

Lens Flare Object

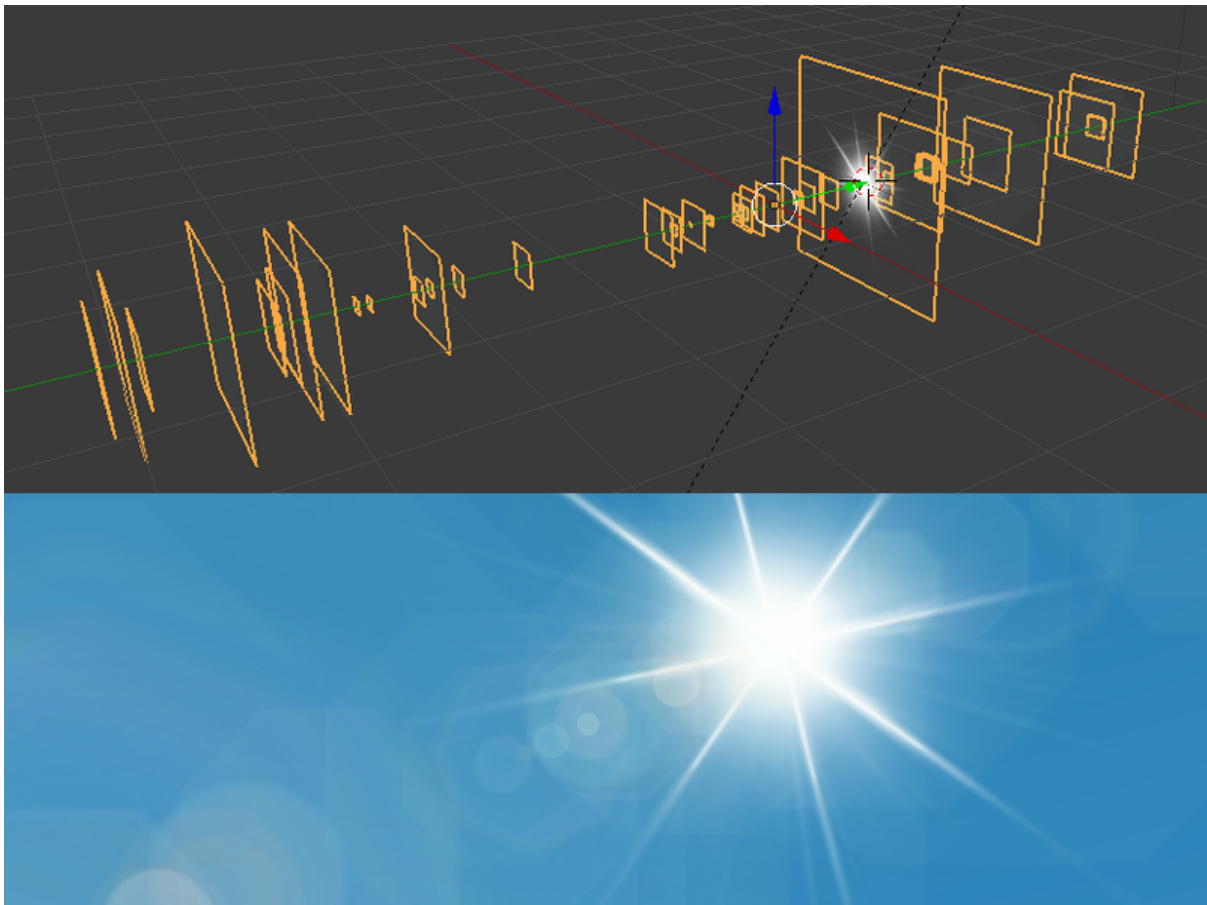

Lens Flare object is used for the actual rendering of the effect. In essence, such an object consists of several planes with each plane containing one element of the flare. The normal vector of each plane should be pointed in the -Y direction. Every element can slide across the screen in relation to camera rotation with the sole exception being the central plane (bright white “star” on the picture above). This plane serves as a center of the lens flare object and should have a local Y coordinate set to 1.

The placement and spatial orientation of the object itself are not taken into account during rendering.

For lens flare object to work correctly, the Disable Frustum Culling option should be activated.

An example of such object can be seen, for example, in our Island demo.

Material Settings

The material used for the lens flare object should have the Alpha Blend transparency type. Alpha parameter should be set to zero.

Node materials are not supported.

Texture Settings

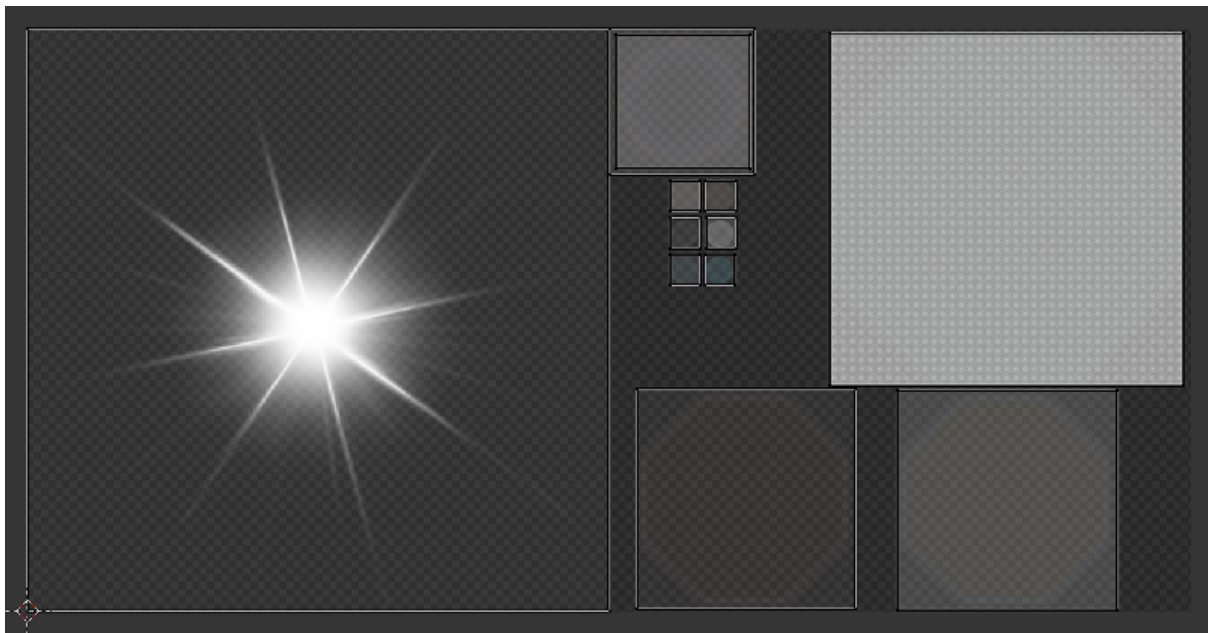

Figure 26.1: An example of texture used to generate Lens Flare effect.

The texture used for the Lens Flare object should contain all elements used to form the shape of the flare in an actual application. The texture image should use Alpha channel and influence both Color and Alpha values.

Wind

Wind strength and direction affect:

- grass and tree leaves animation
- particle system dynamics

- water waves rolling frequency (at the moment only strength is taken into account)

Activation

Add a force field object of the Wind type.

Setting up

Direction Direction can be set by rotating the force field object.

Force Fields > Strength Wind strength. Located under the Physics tab. The default value is 1.0.

Animation of Grass and Tree Leaves

Authoring resources for grass rendering is described in the [Grass](#) section.

Activation

Enable the Wind Bending panel for the grass or tree object.

Setting up

The interface panel becomes visible after turning on the Wind Bending panel.

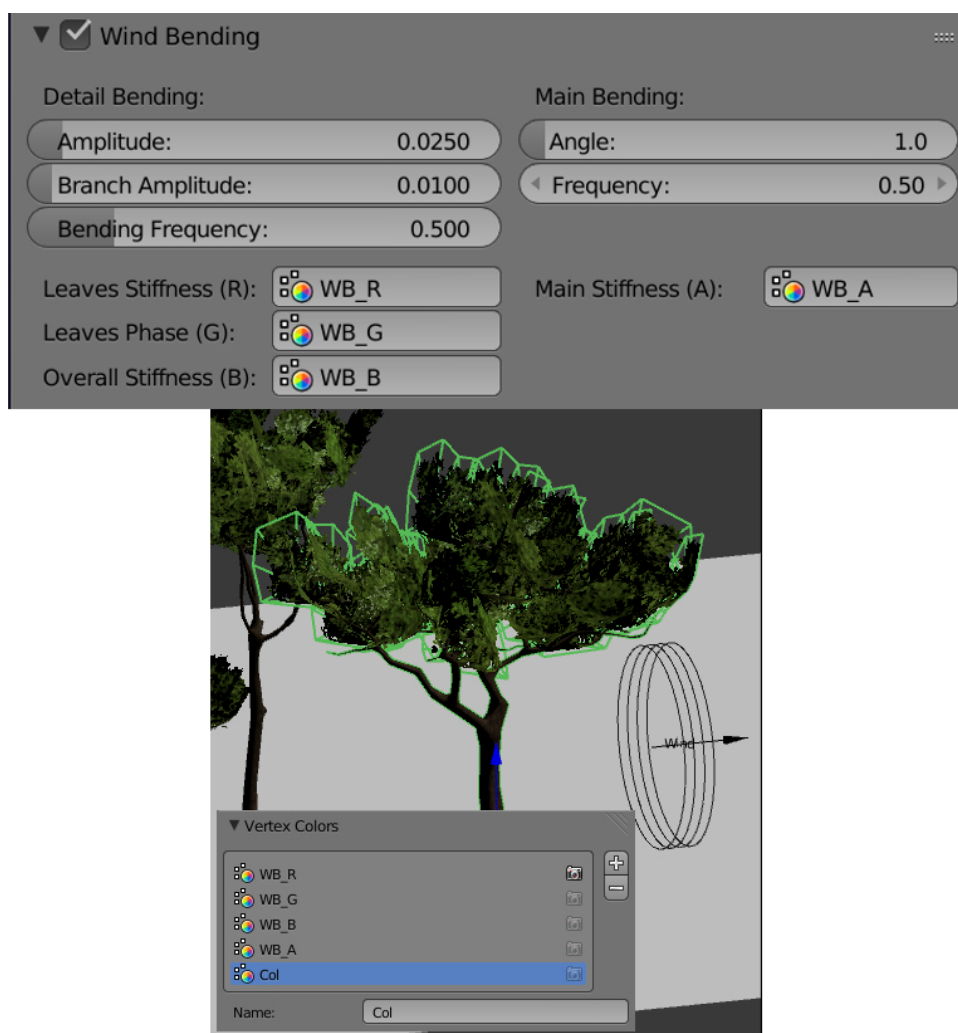

Main Bending > Angle Angle amplitude of the “main” deviation under the influence of wind (in degrees). The default value is 10.0.

Main Bending > Frequency Frequency of the “main” deviation under the influence of wind. The default value is 0.25.

Main Bending > Main Stiffness (A) Text field for specifying the name of the vertex color layer which contains the information about the stiffness of the “main” deviation. Can be left empty.

Detail Bending > Amplitude Angle amplitude of the “detail” deviation caused by the influence of wind (in degrees). The default value is 0.1.

Detail Bending > Branch Amplitude Angle amplitude of the branch deviation caused by the influence of wind (in degrees). The default value is 0.3.

Detail Bending > Bending Frequency Detail bending frequency. The default value is 1.0.

Detail Bending > Leaves Stiffness (R) Text field for specifying the name of the vertex color layer which contains the information about the stiffness of leaves. Can be left

empty.

Detail Bending > Leaves Phase (G) Text field for specifying the name of the vertex color layer which contains the information about the phase of leaves deviation. Can be left empty.

Detail Bending > Overall Stiffness (B) Text field for specifying the name of the vertex color layer which contains the information about the overall stiffness of leaves. Can be left empty.

Vertex color layers should be present in the mesh if their names are specified.

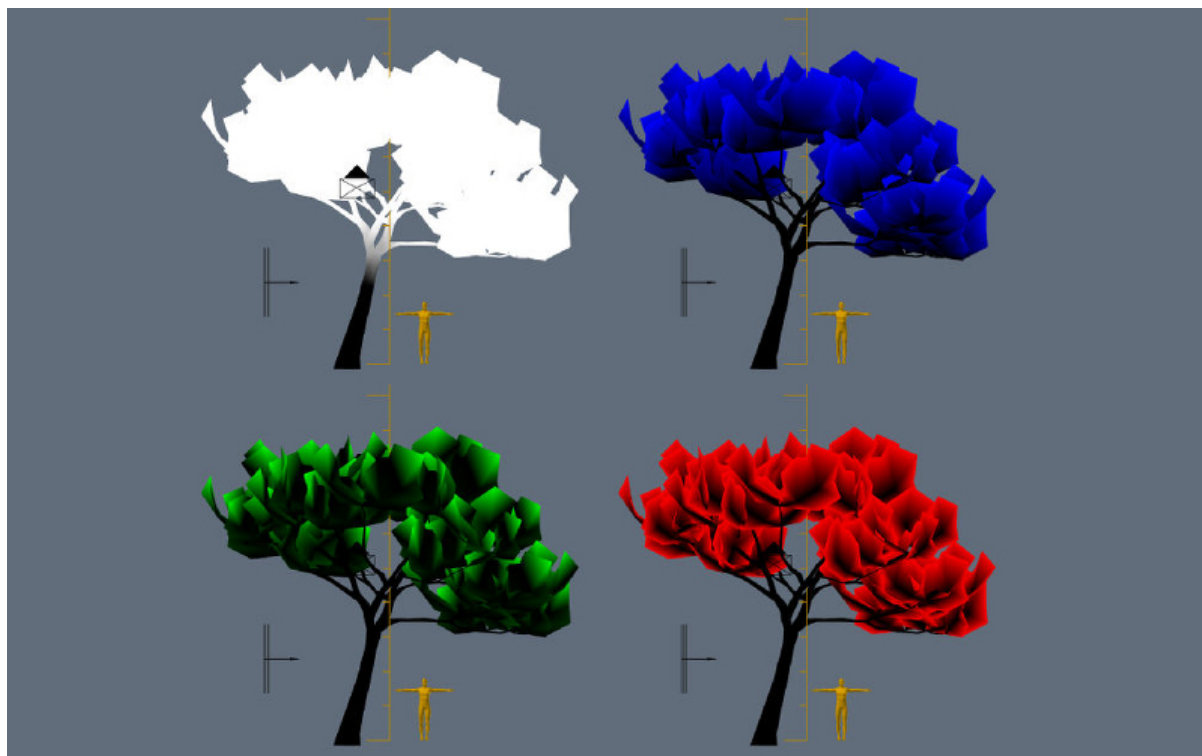

Color Management

Table of Contents

- Color Management
 - Gamma Overview
 - Human Vision and Monitors
 - Gamma Formula
 - Gamma in Node Materials
 - * Nodes for Coloring
 - * Nodes for Masking
 - * Normal Maps
 - * Summary Table
 - Alpha Compositing
 - * Overview
 - * Implementation
 - Color Correction
 - * Activation
 - * Additional settings

Gamma Overview

The essence of gamma correction is packing the image brightness channel into 8 bits of information.

Standard (non-HDR) images are always stored in non-linear color space where the darker components are encoded using more bits than the brighter ones. That means that a bigger RGB value corresponds to 0.5 of the real light intensity (a physical quantity called illuminance) - in the simplest case this value equals to $0.5^{1/2.2} = 0.73$.

Otherwise, 8 bit of information will not be enough to encode the light intensity. This will result in incorrect rendering of darker tones. For example, dark gradients will look stepped.

Therefore, web browsers, as well as many other programs for viewing and manipulating

images, work in non-linear space. However, 3D engines and renderers work in linear space, because it is the only correct way to represent light behavior in the real world. For example, the illuminance from two identical lamps exceeds the illuminance from one lamp exactly by two times.

Undoubtedly, 8 bit of information will not be enough in this case. This can be clearly seen from the table in which approximate illuminance values for some real light sources are shown.

Description	Illuminance, lux
Summer noon	17 000
Winter noon	5 000
Dull day	1 000
In a light room	100
Full moon by night	0.2
Moonless light	0.001

When the Color Management > Display Device > sRGB option is enabled for a scene, Blender works in a linear space. Material colors and lamp settings correspond to physical values. For texture images (except normal maps) it is required to select the Image > Input Color Space > sRGB option. In this case an automatic image unpacking (sRGB -> Linear) is performed at the time of rendering.

Human Vision and Monitors

While the human vision is non-linear (a human recognizes the darker light tints better than the brighter ones), the light coming into the eye still obeys the physical laws (see the lamps example).

In CRT monitors the brightness is dependent non-linearly upon the electric voltage applied to the monitor's input (the voltage itself is determined by the color channel value in the video memory). LCD monitors mimic the same characteristics. Nevertheless, the light emitted by such monitors obeys the physical laws. For example the addition of a second light source to a virtual scene should cause the brightness to double (in the perfect case).

Therefore, the perception characteristics of the human eye are the reason due to which it is possible to pack color channels. At the same time, the technical characteristics of monitors have a secondary significance for gamma correction.

Gamma Formula

Used in the following simplified formula:

$$V_{\text{out}} = V_{\text{in}}^{\gamma}$$

$\gamma < 1$ - packing gamma, $\gamma > 1$ - unpacking gamma. In the simplest case 1/2.2 and 2.2 values are used respectively. Hereinafter the “packing” (Linear -> sRGB) and “unpacking” (sRGB -> Linear) terms are used instead of “gamma correction”.

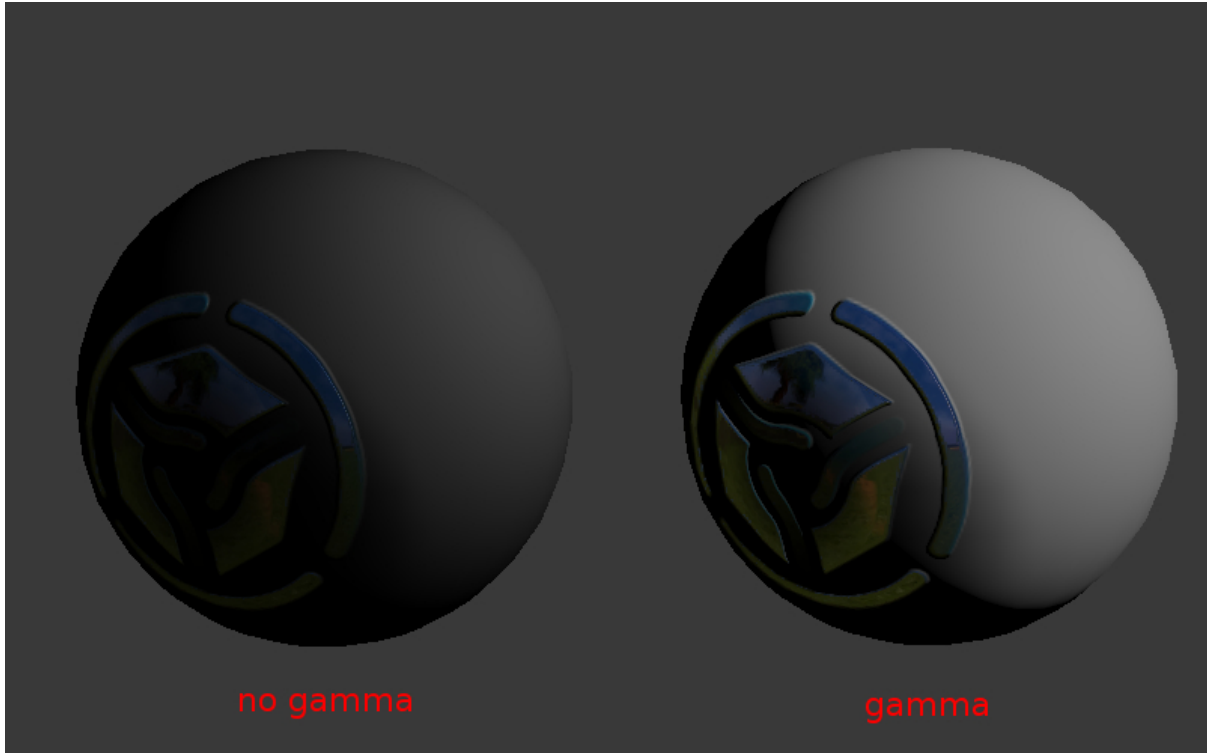

Gamma in Node Materials

Nodes for Coloring

Unpacking (sRGB -> Linear) is required when textures and vertex colors are used for coloring (not for masking). The texture node and Vertex Color output of Geometry node implement unpacking automatically.

Note that the alpha channel of a texture node is not corrected. Its values are in the linear space.

Nodes for Masking

Textures and vertex colors can be used as masks i.e. input data for some mathematical operations. In such a case the packing operation is required.

Keep in mind that a texture node and Vertex Color output of Geometry node implement unpacking automatically. This results in necessity of the additional transformation back to the non-linear space, for which the LINEAR_TO_SRGB or GAMMA node with $\gamma = 1/2.2$ is used.

Note: `LINEAR_TO_SRGB` and `SRGB_TO_LINEAR` nodes are deprecated. `GAMMA` node should be used instead.

Normal Maps

No transformations are performed for normal maps.

Summary Table

Use case	Correction
Texture for coloring	implemented automatically in the texture node (the alpha channel is not corrected)
Texture for masking	GAMMA with $\gamma = 0.45$
Vertex color for coloring	implemented automatically
Vertex color for masking	GAMMA with $\gamma = 0.45$
Normal map	not required

Alpha Compositing

Overview

Physically correct alpha compositing is performed according to the formula [\[source\]](#):

$$C_o = C_a\alpha_a + C_b\alpha_b(1 - \alpha_a).$$

This formula differs from the classic mix operation (aka convex combination) because it has the α_b multiplier in the second summand. Therefore, not only the α_a value of the source pixel should be known for alpha compositing, but also the α_b value of the pixel over which the rendering is performed.

In case of preliminary multiplication of the α values by the color channels (so called premultiplied alpha) the formula becomes as following:

$$C_o = C_a + C_b(1 - \alpha_a).$$

The last formula is used also to calculate the resulting α_o value:

$$\alpha_o = \alpha_a + \alpha_b(1 - \alpha_a).$$

Preliminary multiplication of the color channels by the α values allows to save two multiplication operations. The more significant thing is that the derived formula can be used repeatedly without the need to divide the C_o color by the α_o value on each consequent iteration.

Implementation

The blending function used in Blend4Web is the following:

```
gl.blendFunc(gl.ONE, gl.ONE_MINUS_SRC_ALPHA);
```

WebGL context initialization is performed using the `premultipliedAlpha = true` parameter (that is the default value). Also multiplication of all the color channels by the α value is performed on the output of the shaders.

Color Correction



Activation

Activate the Color Correction panel under the Render tab.

Additional settings

Brightness The default value is 0.0.

Contrast The default value is 0.0.

Exposure The default value is 1.0.

Saturation The default value is 1.0.

Table of Contents

- Audio
 - Audio Source Settings
 - * Sound Tab
 - * Distance Tab
 - * Cone Tab
 - Audio Mixer
 - Processing and Decoding
 - * Supported formats (containers):

Audio sources are created in Blender. The standard Speaker object is used.

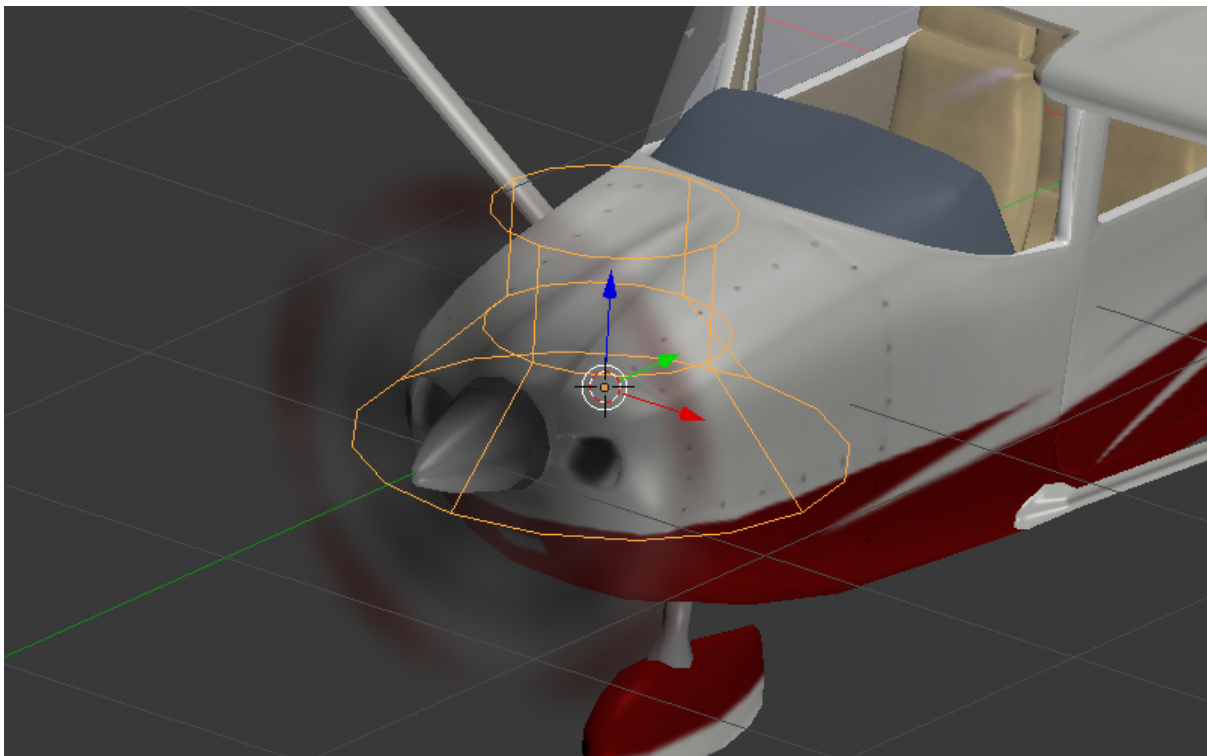

Audio Source Settings

Speaker parameters can be set up on the Properties panel under the Object Data tab.

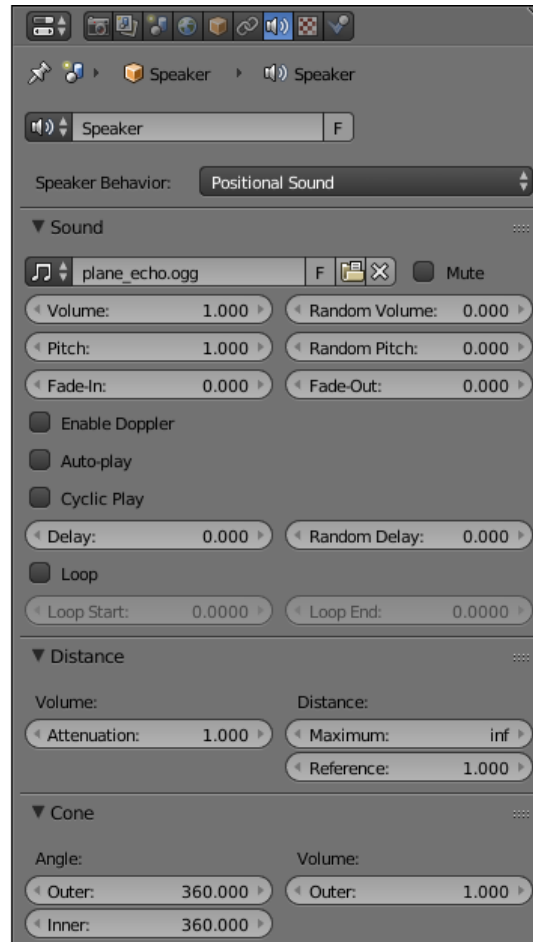

The engine supports all the standard Blender sound parameters and some engine-specific settings.

Sound Tab

Mute

Enabling this parameter mutes the speaker.

Speaker Behavior:

The behavior of the audio source.

Positional — high-quality sound with spatial positioning and directivity (conicity). The Web Audio API is used for sound rendering. Playback performance of such sounds is the least and so use them only for short samples.

This is the default value.

Background Sound — high-quality omnidirectional sound without spatial positioning. The Web Audio API is used for sound rendering. It is more performant but is not effective for music.

Background Music — used for music playback. It has maximum performance due to the use of the Audio HTML tag, but has minimum flexibility.

The following options are available on the Sound panel:

Volume

Speaker volume

Random Volume

Additional volume randomization. The resulting value is calculated as for the delay.

Pitch

Sound playback velocity.

Random Pitch

Additional randomization of the sound playback speed. The resulting value is calculated as for the delay.

Fade-In

Fade-in time interval.

Fade-Out

Fade-out time interval.

Enable Doppler

Turn on the source's frequency shift upon its moving.

Auto-play

This option enables default playback.

Cyclic Play

Loop the sound playback.

Loop

Loop the sound playback. Contrary to the Cyclic play option it guarantees a zero delay upon repeat. The option is available only for sound sources with Positional or Background Sound behavior.

Loop Start

Marks the starting point of the source fragment that will be looped. This value is measured in second counted from the start of the source file.

Loop End

Marks the end point of the source fragment. This value is also measured in seconds.

Delay

Delay before sound playback starts.

Random Delay

Additional delay randomization. The resulting value is calculated according to the formula $Delay_{result} = Delay + Delay_{random} * Random_{[0-1]}$.

Distance Tab

Attenuation

This parameter defines how strong the distance affects the volume. Default value is 1.0.

Maximum

Maximum distance for volume calculation.

Reference

This sets the reference distance at which volume is 100%.

Cone Tab

Angle group of parameters:

Outer

Angle of the outer cone in degrees. Outside this cone the volume is the outer cone volume. Between the inner and outer cone the volume is interpolated.

Inner

Angle of the inner cone in degrees. Inside the cone the volume is 100%.

Volume group of parameters:

Outer

This sets the volume outside the outer cone.

Audio Mixer

This feature can be found in the Scene Viewer.

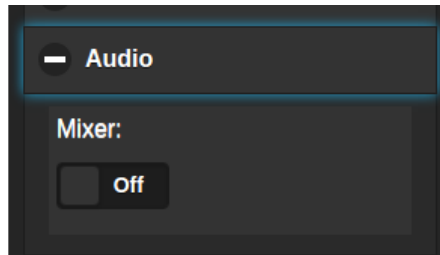

Enabling it shows an equalizer interface that contains various parameters of the Speakers present in the scene.

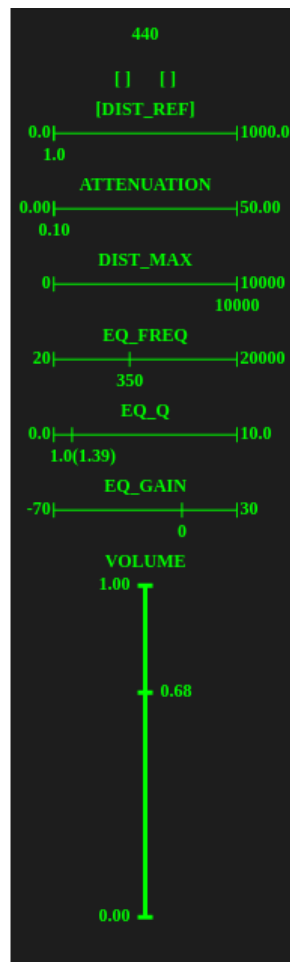

The parameters available for sound mixing include:

DIST_REF This value sets the reference distance of a specific speaker. Available only for Positional Sound type speakers.

ATTENUATION This value sets the attenuation factor for the sound emitted by a selected speaker. Available only for Positional Sound type speakers.

DIST_MAX This value shows the maximum distance for a specific speaker. If the distance from the camera to the speaker is greater than this number, the speaker won't

emit any sound. Available only for Positional Sound type speakers.

EQ_FREQ The center frequency of where the boost is applied.

EQ_Q The Q factor. This value controls the width of the band of frequencies that will be boosted. Increasing the value of this parameter reduces the width.

EQ_GAIN This value controls the boost (measured in dB) that will be applied to the sound emitted by the speaker.

VOLUME The volume of a sound emitted by the speaker.

Below this list, a frequency characteristic of a parametric equalizer is shown.

The mixer can be controlled using a numerical keypad.

- Keys 8, 4, 6 and 2 act like arrow keys and are used for switching between different speakers and their parameters.
- Keys + and - increase and decrease the value of a selected parameter.
- The 7 key can be used for muting the selected speaker.
- The 9 key can be used for making the selected speaker Solo (only this speaker will emit sound).

Processing and Decoding

Supported formats (containers):

- ogg, Vorbis codec (Chrome, Firefox)
- mp3 (Chrome, Safari)
- mp4, AAC codec (Chrome, Safari)

It is recommended to use Ogg as it is an open standard, is widespread in browsers and provides good sound quality. The optimal format in respect to the quality and compatibility is 48kHz/16bit. Single-channel sound (mono) is used to store shot samples while two-channel sound (stereo) is used for music playback.

Converting resources between different formats is described in the [corresponding section](#).

Table of Contents

- Physics
 - Preparing for Use
 - Static Physics Type
 - Dynamic Physics Type
 - Constraints
 - Wheeled Vehicles
 - * Chassis Settings
 - Floating Objects
 - * Floating Object Settings
 - Floating Vehicles aka Watercrafts
 - * Watercraft Settings
 - Characters
 - * Character Settings
 - * Basic Character
 - * Controlling Characters with API
 - Navigation Meshes
 - * Creating Navigation Meshes
 - * Using Navigation Meshes
 - Use in Applications

Preparing for Use

In order to enable physics on the scene, please use the Enable Physics checkbox in the Physics panel under the scene tab in Blender.

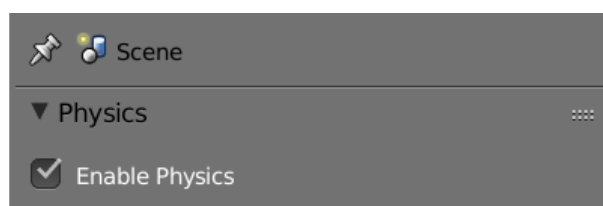

Static Physics Type

Can be used to limit the movement of other objects, for example to detect collisions with a landscape, walls and so on. In the physics settings of such an object the Static value (set by default) should be selected for the Physics Type option.

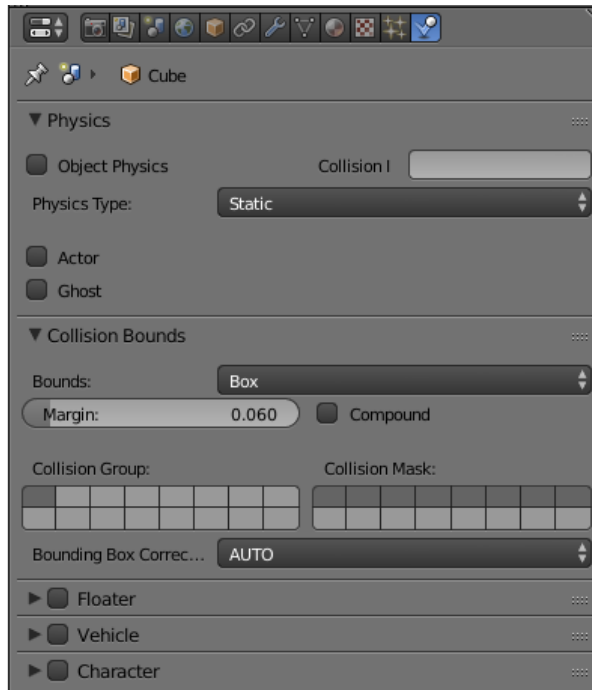

One or multiple physics materials can be assigned to a mesh. Under the Material tab the Special: Collision panel must be activated.

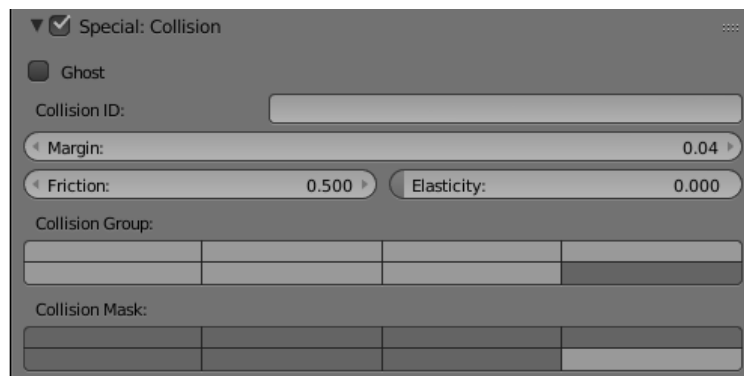

The Ghost option excludes the material from physical interactions but still notifies the application about the contact with it. An example - detecting that the character is located on a vertical ladder.

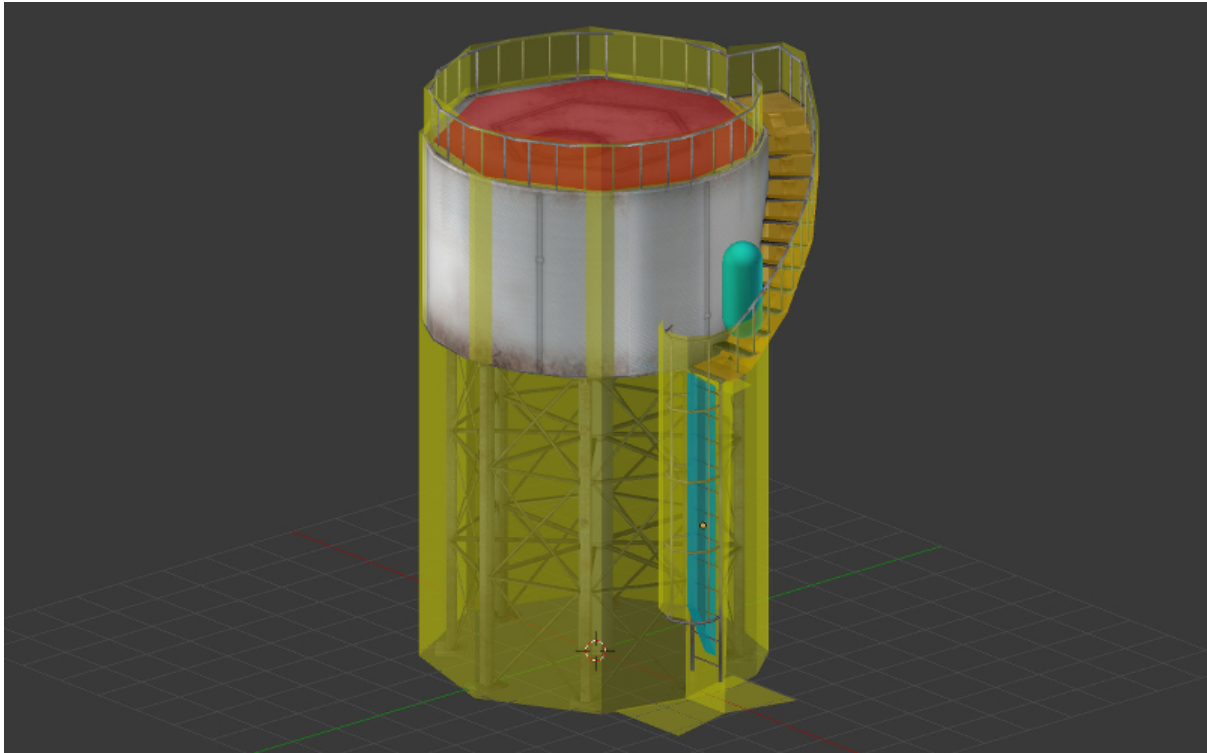

The Collision ID field is intended for detecting collisions with specific materials and can be left empty. An example of Collision ID usage is detecting the landscape surface a character is located on - grass, sand, wooden coating and so on.

The Margin field allows to customize the width of the zone where mesh reacts on collisions. This option improves physical collisions simulation stability.

Also, there are material physics settings in this panel. The following settings are supported: Friction, Elasticity.

The Collision Group field corresponds to the physics group which the material belongs to. The Collision Mask field defines all physics groups with which this material will interact.

Dynamic Physics Type

Intended for rigid body movement simulation.

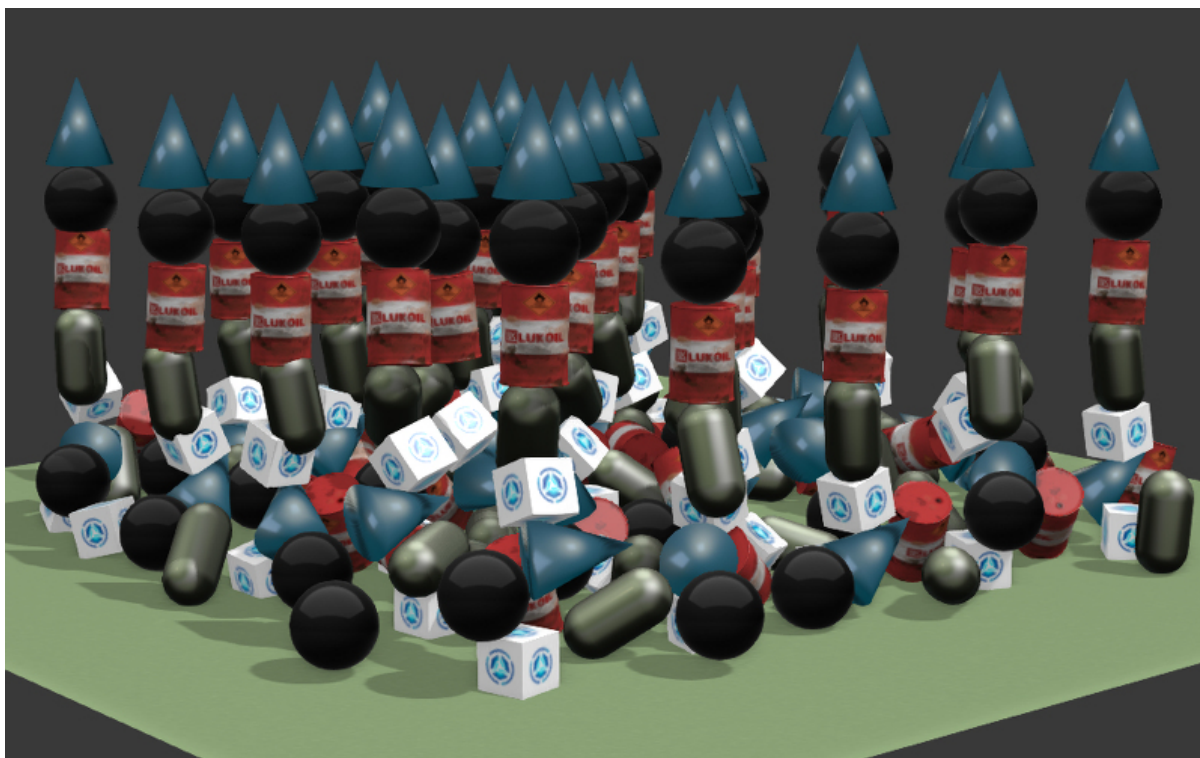

The Object Physics checkbox must be enabled under the object's Physics panel. The Collision ID field is intended for detecting collisions with a specific object (for example, for detecting proximity of a FPS character to different items) and can be left empty.

In the physics settings of such an object the Rigid Body (with rotations) or Dynamic (without rotations) values can be selected for the Physics Type option. In the Collision Bounds settings the collider type can be selected - the supported types are: Box, Capsule, Sphere, Cylinder, Cone. Also, the following physics parameters can be set: Mass, Damping - for Translation and Rotation.

The Collision Group field corresponds to the physics group which the object belongs to.

The Collision Mask field defines all physics groups with which this object will interact.

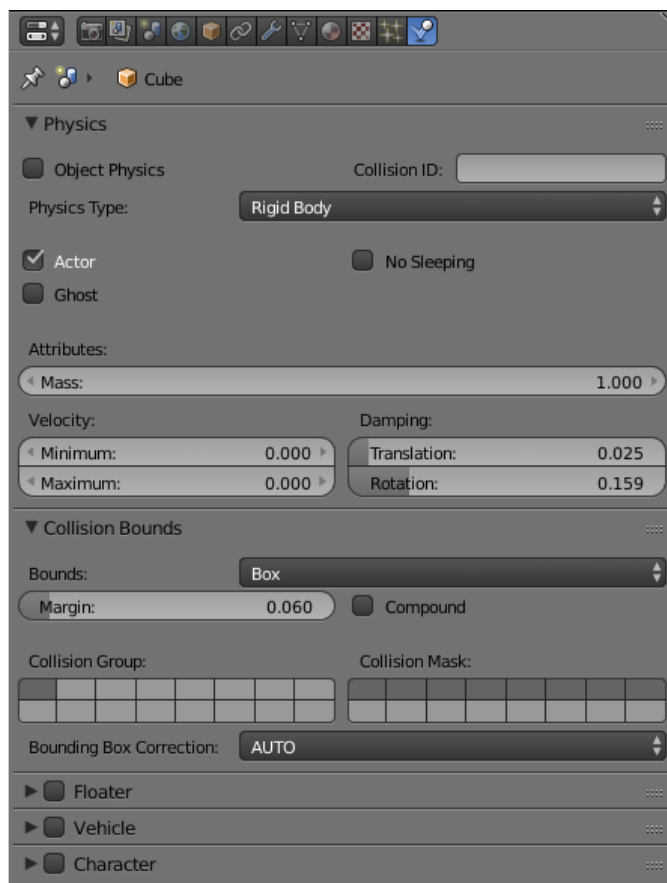

Friction and Elasticity are supported for the material of such an object. When multiple materials are used on a single mesh, the physics parameters are taken from the first of them.

For the camera object the Physics Type = Dynamic parameter must be used, and the Object Physics checkbox must be enabled.

Constraints

Physical constraints are used for limiting the objects' degrees of freedom.

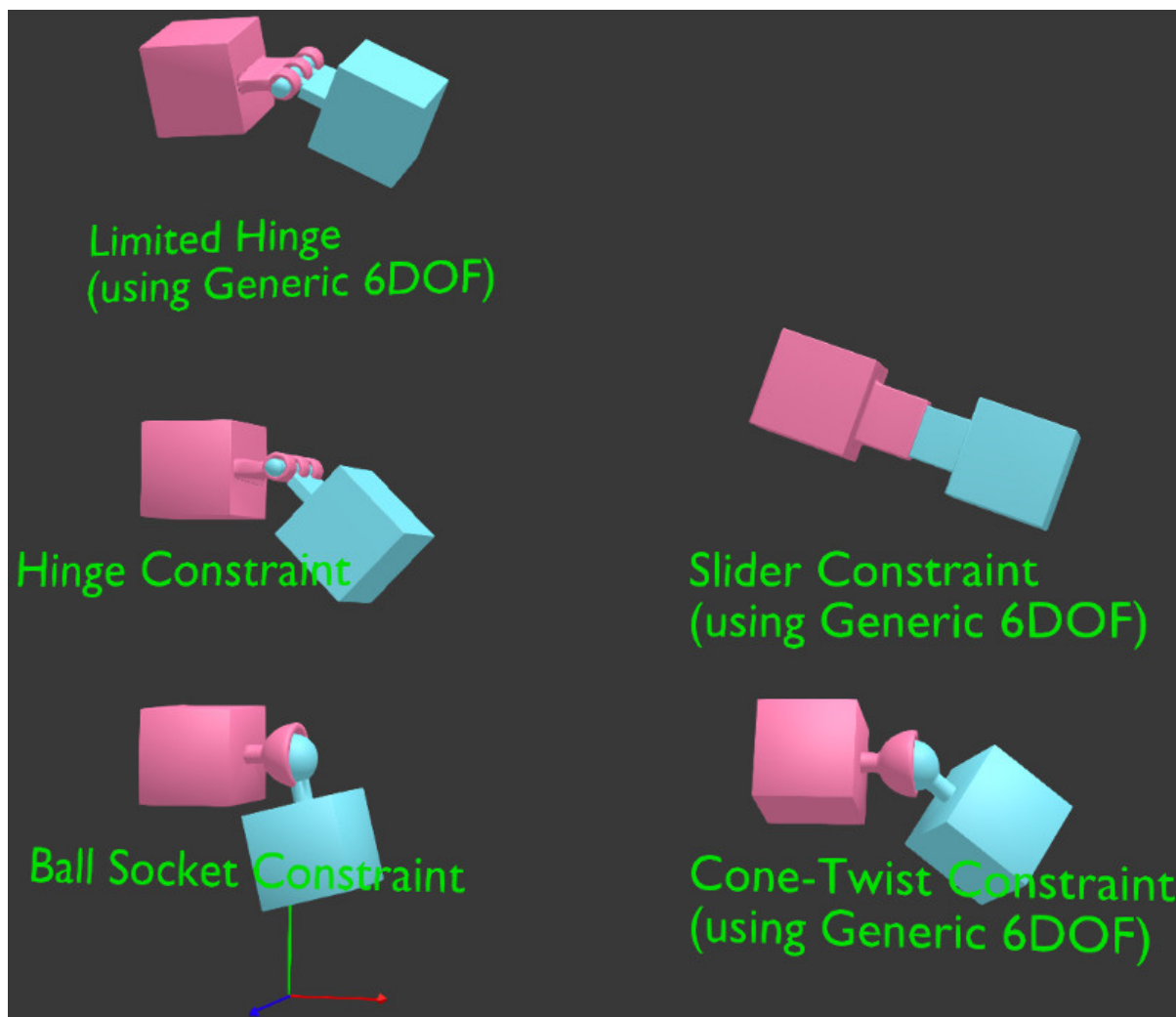

Adding a physical constraint (Rigid Body Joint) to the object can be performed on the Object Constraints panel. The supported types (Pivot Type) are: Ball, Hinge, Cone Twist, Generic 6 DoF. A physical constraint can be added to one of the two interacting objects, while the other object acts as a Target. Both objects can have a static and/or dynamic physics type. In constraints (except Ball) the translation and rotation limits can be set up.

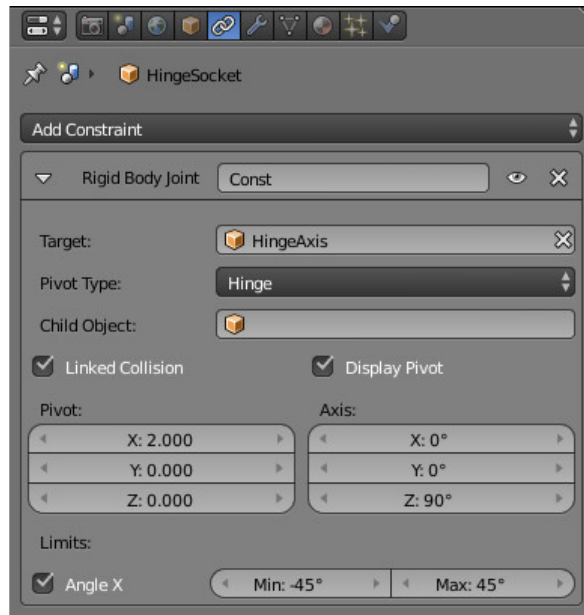

Wheeled Vehicles

The model of a vehicle must consist of 6 separate objects - a chassis, 4 wheels and a steering wheel. The chassis' mesh center should correspond to the mass center. The centers of the wheels' and the steering wheel's meshes should be located on the rotation axes. The steering wheel should be oriented in the local space of coordinates - X - the rotation axis, Y - to the right and Z - upwards. The object can have any names.

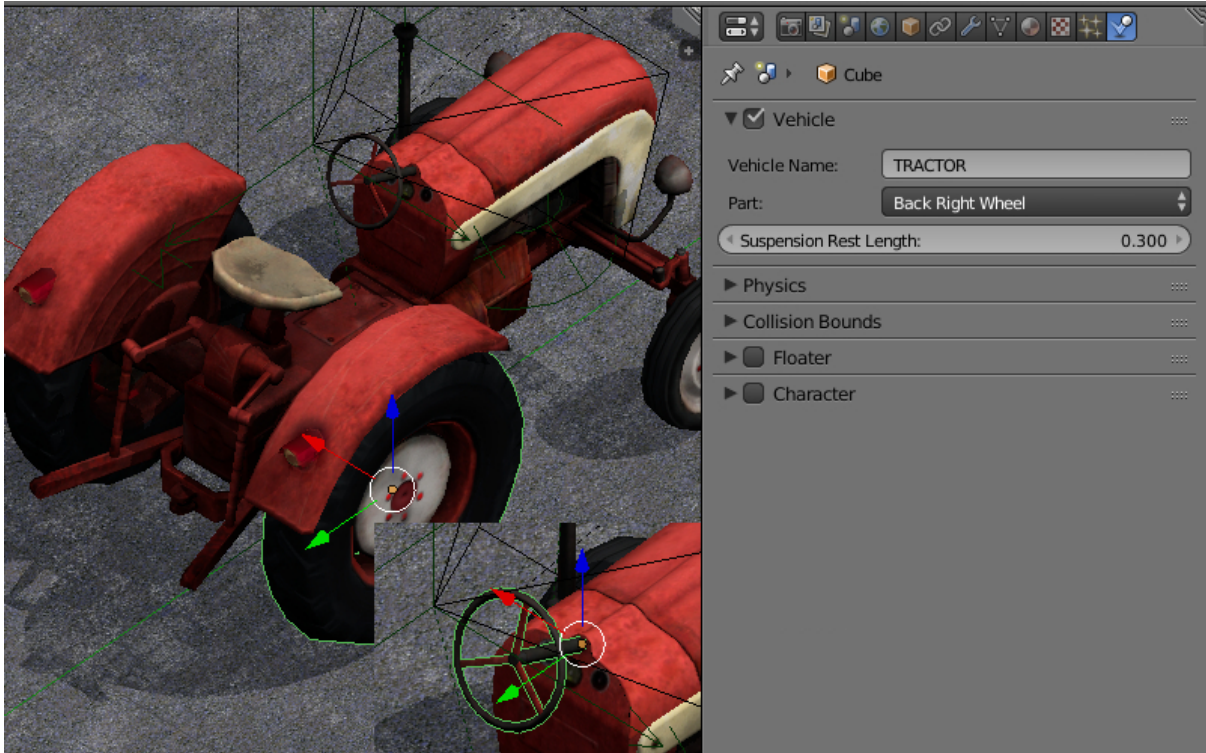

For all 6 objects: select the Part, specify the same id in the Vehicle Name field, select the right object type - Chassis, Steering Wheel, Back Right Wheel and so on. The Suspension Rest Length setting is also available for the wheels.

It is necessary to specify a realistic mass for the chassis (because the default value is only 1 kg). To do this go to the physics settings, choose the Rigid Body value for the Physics Type option and specify the required value (for example, 1000 kg) in the Mass field.

Chassis Settings

Force Max Maximum driving force of the vehicle.

Brake Max Maximum braking coefficient.

Suspension Compression Damping coefficient for suspension stretching.

Suspension Stiffness Suspension stiffness coefficient.

Suspension Damping Suspension damping coefficient.

Wheel Friction Friction constant between the wheels and the surface. It should be around 0.8 for realistic vehicles. But it can be increased significantly to achieve a better control (1000 and more).

Roll Influence Decreases the wheels' torque decreasing the probability of the vehicle overturning (0 - no torque, 1 - real physics behavior).

Max Suspension Travel Cm Maximum suspension travel in centimeters.

For the Steering Wheel it is necessary to specify the maximum steering angle (Steering Max) and the ratio between the turn of the steering wheel and the turn of the wheels (Steering Ratio). The maximum steering angle value is specified in revolutions. A single revolution equals to 360 degrees. Therefore, if Steering Max is equal to one and Steering Ratio is equal to 10, the maximum turn of the steering wheel will be 360 degrees and the maximum turn of the front wheels will be 36 degrees.

On this stage you can export and load the scene into the engine. We recommend to create a road surface with a physics material. To choose the controlled object press the Q key in the Viewer and select the chassis. Use the W, A, S, D keys as controls.

We can additionally tweak the Damping of Translation and Rotation. This will influence the speed and inertia of the vehicle.

The friction and elasticity of the road surface material do not influence the vehicle's behavior.

Floating Objects

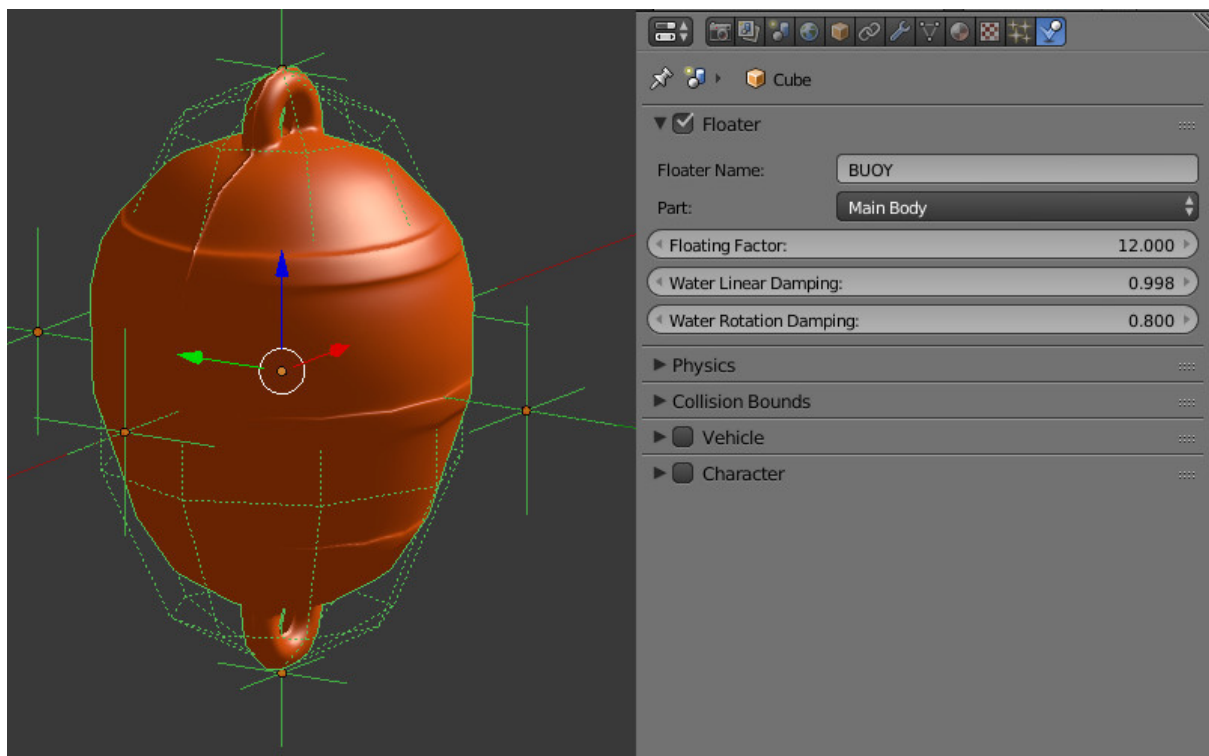

In order for the object to float on the water surface (an object with the Water material), it is necessary to enable the Floater panel. There are two types of floating objects:

Main Body - the floating object itself and Bob - an auxiliary bob-object onto which the buoyancy will be acting. A floating object can have an unlimited number of Bob objects. This can be both meshes or Empty objects.

All objects that are part of the same floating object must have the same name in the Floater Name field.

Floating Object Settings

Floating Factor Buoyancy coefficient.

Water Linear Damping Linear velocity damping when the object is on the water surface (or under water). When the object is not in water, the physics settings are used.

Water Rotation Damping Rotation damping when the object is on the water surface (or under water). When the object is not in water, the physics settings are used.

Floating Vehicles aka Watercrafts

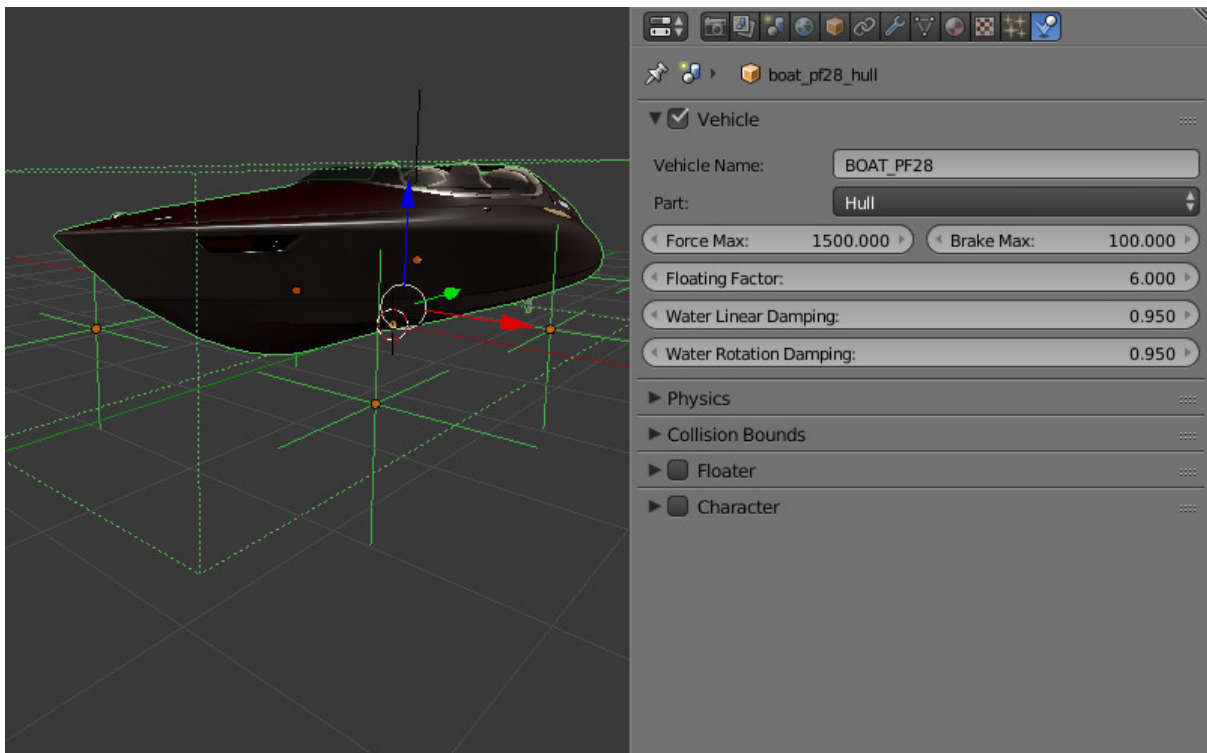

Watercrafts use some parameters from the Vehicle settings and all the settings which are similar to Floater setting. It is necessary to set the Part type Hull on the main object. Similar to a floating object a watercraft requires auxiliary Bob objects.

Watercraft Settings

Force Max Maximum driving force of the vehicle.

Brake Max Maximum braking coefficient.

Floating Factor Buoyancy coefficient.

Water Linear Damping Linear velocity damping when the object is on the water surface (or under water). When the object is not in water, the physics settings are used.

Water Rotation Damping Rotation damping when the object is on the water surface (or under water). When the object is not in water, the physics settings are used.

Characters

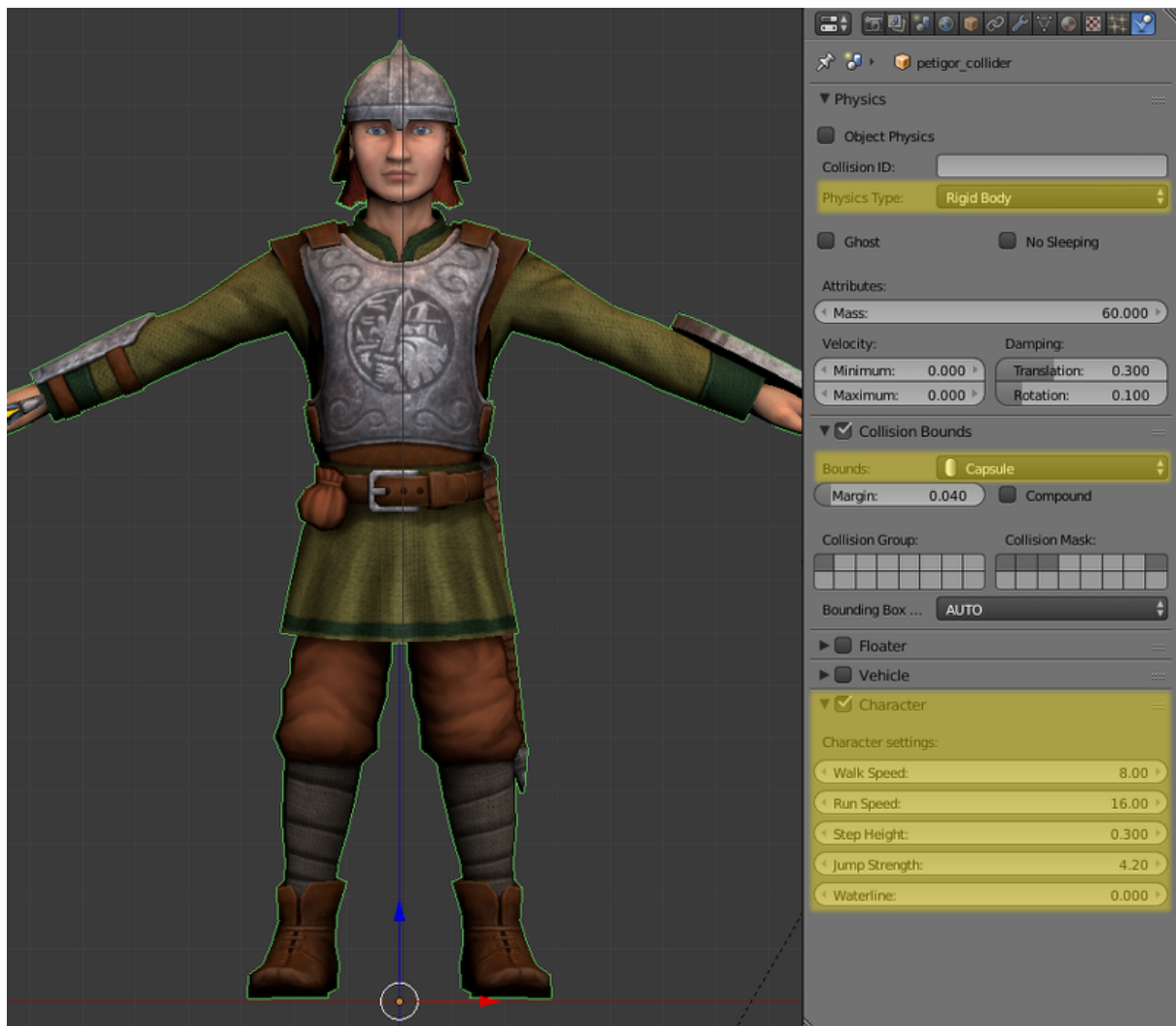

This feature can be activated by clicking the Character check-box in the title of the eponymous tab on the Physics panel.

From the engine standpoint, the character itself is a proper physical object that can collide with other physical objects or be influenced by physical forces such as gravity and

buoyant force.

Character object can be easily controlled using several API methods with a character keyword in their names. All such methods reside in the [physics](#) API module.

Character Settings

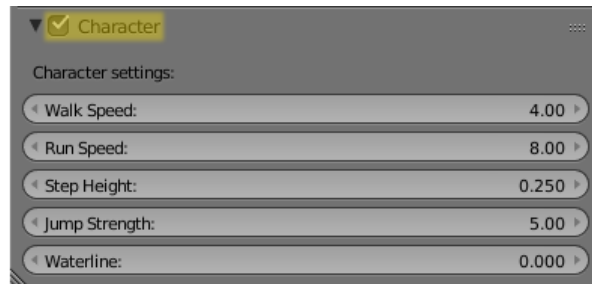

All the settings listed here become available after activating the Character tab.

Walk Speed This parameter sets the speed of a character walking (measured in meters per second). The lowest possible value of this parameter is zero, while the highest is 10.

Its default value is 4.

Run Speed This is the speed of the character running (measured in meters per second). Its value can vary from zero to 20.

This parameter is set to 8 by default.

Step Height This is the maximum height of an obstacle that character can overstep (in meters). The value of this parameter can vary from zero to 1.

Default value of this parameter is 0.250.

Jump Strength This parameter sets the strength of the character jumping. Its minimum value is zero, while its maximum value is 50.

Set to 5 by default.

Waterline This parameter sets up the waterline for the character object. The waterline is measured from the center of the physical shape of the object (not the object's mesh). If an object is submerged into the water below this line, it will float. Its value can vary from -2 to 2.

It is set to zero by default.

Basic Character

Blend4Web engine has an option to quickly set up a user-controlled first-person character. Such character will only have very basic functionality, but can be set up without any programming.

To set up a basic character, follow these steps:

1. Select an object you intend to use as a character.
2. Enable physics for the selected object and set physics type to Dynamic or Rigid Body.
3. Enable Character option for the object.
4. Create a new Camera or select an existing one and set its type to Eye.

Now a basic character with an attached camera will be present in your scene.

The character can be controlled in mostly the same way as a regular Eye type camera:

- WASD keys move the character.
- Camera angles are controlled by arrow keys or moving the mouse while holding its left button.
- Pressing the C key toggles fly mode (enabled by default).

Note: Only one basic character can be present in the scene. If a scene has multiple characters, the engine will use the first of them as the basic character and ignore the others.

Controlling Characters with API

Basic character described above can only provide generic functionality. If you need more control over character behavior, you should use methods from the `fps` module.

The most important of them is the `enable_fps_controls()` method which, as its name suggests, is used to initialize characters in the scene. It can be used as follows:

```
var m_fps = require("fps");  
m_fps.enable_fps_controls();
```

This method should be used at the start of the application (in the `load_cb` function) to enable character controls.

Note: This method may conflict with the `enable_camera_controls()` method which is used to enable basic character described in the previous section. These two methods should not be used simultaneously.

The method also has the following optional parameters:

`character` sets the character object. The link to the character can be retrieved by calling the `get_first_character()` method. Should be used if more than one character is present in the scene.

`element` specifies the HTML element to which the method adds listeners.

`motion_cb` specifies the callback function that is called when character changes its direction.

`gamepad_id` specifies the ID of the gamepad plugged to the system.

`forward_sens`, `backward_sens`, `right_sens`, `left_sens`, `jump_sens`, `fly_sens` - these parameters are used to set arrays of sensor types for specific character action like walking in different directions, jumping and so on.

`rotation_cb` specifies the callback function that is called when a character or camera rotates.

`lock_camera` - setting this parameter to true will parent the scene camera to the character.

Other important methods are `set_cam_sensitivity()` and `set_cam_smooth_factor()`. The first one of them sets the sensitivity of the camera (defined by a numeric value in the range from zero to 100). The second method defines how smooth the camera moves (defined by a value in the range from 0 to 1.0).

Character States

Character states are constant values that represent current behavior of the character (does it currently walk or fly or do anything else). Every character present in a scene always have one and only one state.

Available character states:

`CS_CLIMB` - a character is climbing.

`CS_FLY` - a character is flying.

`CS_RUN` - a character is running.

`CS_STAY` - a character does not move.

`CS_WALK` - a character is walking.

Current state of a specific character can be retrieved using the `get_character_state()` method, while a specific state can be assigned to a character with the `switch_state()` method. The following example shows how these two methods can be used:

```
var m_fps = require("fps");

var current_state = m_fps.get_character_state();

if (current_state == m_fps.CS_FLY)
    m_fps.switch_state(m_fps.CS_WALK);
```

Action Binding

The `fps` module also provides means for binding various actions to character events. The `bind_action()` method is used for this:

```
var m_fps = require("fps");
var m_ctl = require("controls");

var action_cb = function(value) {
  console.log("Q key pressed.");
}

m_fps.bind_action(m_fps.AT_PRESSED, [m_ctl.KEY_Q], action_cb);
```

This method features the following parameters:

- the first parameter is the type of action:
 - `AT_CONTINUOUS` - an input type that detects a continuous user action such as mouse movement, keyboard key held down, gamepad stick tilt etc.
 - `AT_PRESSED` - this input type detects a discrete user action, e.g. pressing a button.
 - `AT_RELEASED` - an input type that detects button (mouse, gamepad or keyboard) being released.
- the second parameter defines an array of sensor types (such as keyboard keys, gamepad buttons or mouse actions).
- `action_cb` is a callback function that will be called each time user performs action defined by the first parameter.

Navigation Meshes

Navigation meshes (commonly abbreviated navmeshes) are mesh objects that are used to make pathfinding simpler by eliminating the need for additional calculations such as collisions.

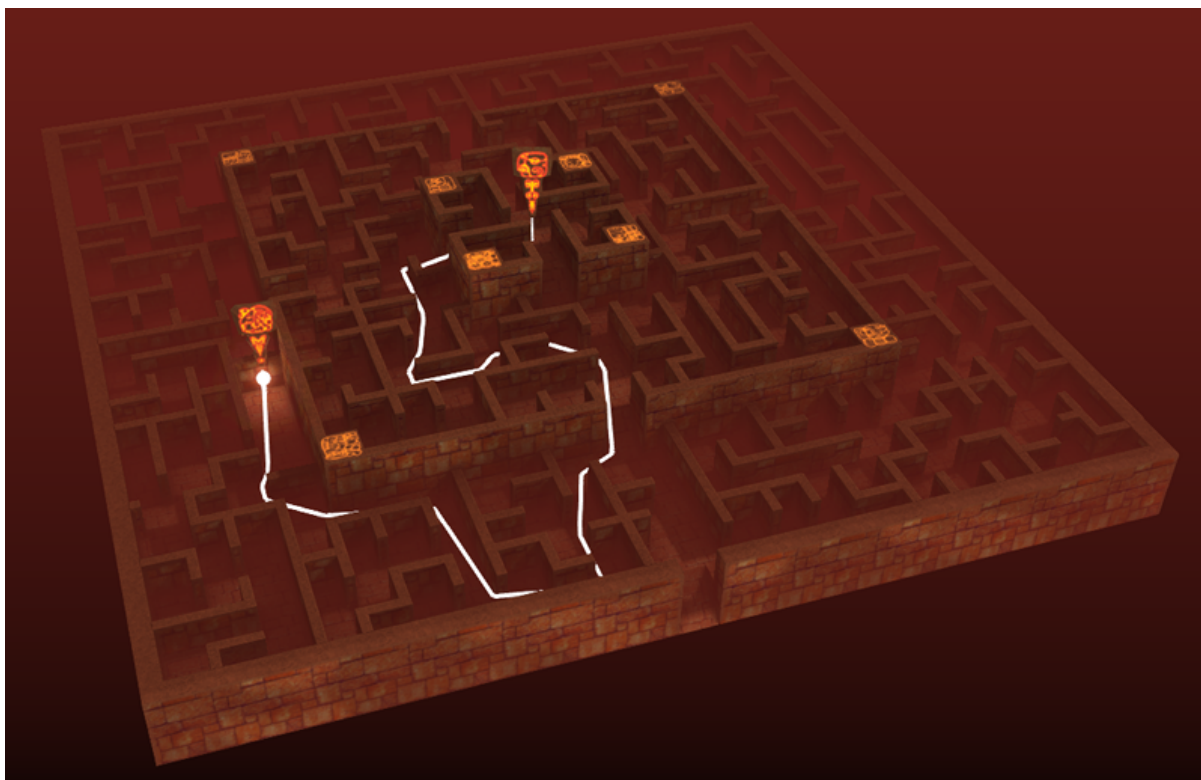

In this example (taken from Code Snippets), navigation mesh is used to build a path through the labyrinth.

Creating Navigation Meshes

To make a navmesh out of an object, turn on the Object Physics parameter on the Physics panel and select Navigation Mesh from the Physics Type list.

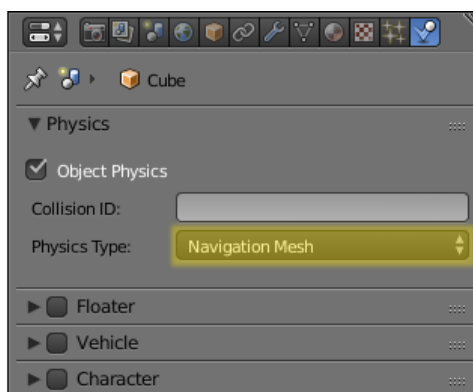

Navigation meshes can either be created manually or generated automatically using a specific tool.

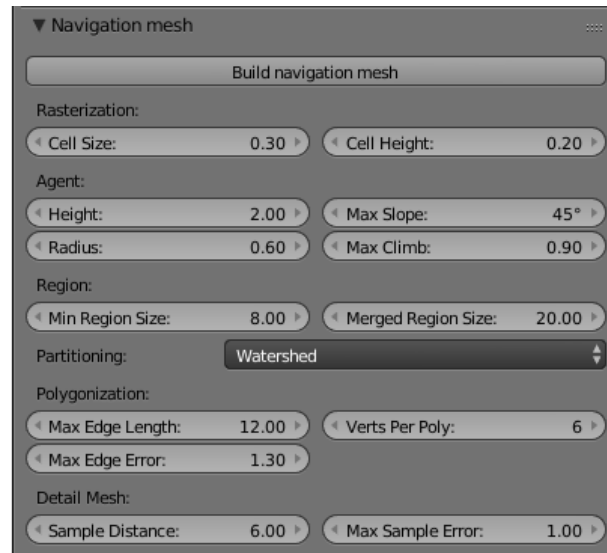

Note: This tool is native to Blender and not a part of the Blend4Web engine.

This Navigation Mesh generation interface can be found on a dedicated panel under the Scene tab, but, as this feature is intended for real-time applications, it only appears if the Engine type is set to Blend4Web or Blender Game (Blender Internal, Cycles or any other rendering engine won't do).

The main tool on this panel is the Build Navigation Mesh button. As the title suggests, it is used for building navigation meshes based on the currently selected object. The navmesh is created as a separate object placed above the selected object, thus leaving that object intact.

Aside from this button, the Navigation Mesh panel offers users several groups of parameters to fine-tune the navmesh that will be generated.

Rasterization group of parameters:

Cell Size Rasterized cell size. Greater values lead to bigger navmesh polygons. The highest possible value is 1.0. Default value is 0.3.

Cell Height Rasterized cell height (the distance between the navmesh and the object from which it was generated). Default value is 0.2.

Agent group of parameters:

Height Minimum height where the agent can still walk. Default value is 2.0.

Radius The radius of the agent. Default value is 0.6.

Max Slope Maximum angle of a slope agent can walk on. Measured in degrees. Default value is 45.

Max Climb The maximum height between grid cells the agent can climb. Default value is 0.9.

Region group of parameters:

Min Region Size The minimum size of a region (smaller regions will be deleted). Default value is 8.0.

Merged Region Size The minimum size of a region (smaller regions will be merged). Default value is 20.0.

Partitioning The method used to partition the navigation mesh. Supported methods are:

Monotone is the fastest method. Using it may generate long thin polygons.

Layers — a slower, but still reasonably fast method that produces better triangulations than Monotone partitioning.

Watershed — classic Recast partitioning method that generates the nicest tessellation. This option is selected by default.

Polygonization group of parameters:

Max Edge Length The maximum length of a contour edge. Default value is 12.0.

Max Edge Error The maximum error of the distance from the contour to the cells. Default value is 1.3.

Verts Per Poly The maximum number of vertices per polygon. Default value is 6.

Detail Mesh group of parameters:

Sample Distance Detail mesh sample spacing. Default value is 6.0.

Max Sample Error Maximum error of the mesh simplification. Default value is 1.00.

Using Navigation Meshes

After a navmesh is created, it then can be used in the application for calculating trajectories between two points. This can be done using two methods from the `physics` module, `navmesh_get_island()` and `navmesh_find_path()`. The former is used to retrieve a link to the current island (closest independent segment of the navmesh), while the latter returns the actual path in the form of an array of coordinates.

An example of using navigation meshes for pathfinding can be viewed in the [Code Snippets](#) (the corresponding snippet is named Pathfinding).

Use in Applications

The physics system is implemented in the `uranium.js` module and loaded separately from the engine's main code. The `uranium.js` module itself is a modification of the [Bullet](#) physics engine, which is ported to work in browsers. In order to activate the physics system, it is enough to put the `uranium.js` and `uranium.js.mem` files in the same directory as the source code of the application.

Another way is to explicitly specify the loading path of the `uranium.js` module by using the following API method:

```
m_config.set("physics_uranium_path", ".../uranium.js");
```

Note: When applications are developed [within the SDK](#), the path to the physics engine is detected automatically.

If your application does not use physics, we recommend you to turn off the Enable Physics flag in the Physics panel under the scene tab in Blender. It is also possible to forcibly disable loading of the uranium.js module by calling the following method before initialization of the engine:

```
m_config.set("physics_enabled", false);
```

Physics subsystem is implemented in the “uranium” module and is loaded independently from the main engine code. The “uranium” module is a modification of the [Bullet physics engine](#) ported to work in web browsers.

Blend4Web physics engine comes in two variations: the one compiled using WebAssembly (uranium_wasm.js and uranium_wasm.wasm files) is used by default, while the other version, compiled with asm.js (uranium.js and uranium.js.mem) can be used as a fallback. The WebAssembly version is smaller in size, can be initialized quicker and using it might improve the stability and performance of the application. However, at the moment not every browser supports WebAssembly, so, if this technology is not available, the asm.js version of the physics engine is used instead.

By default, physics engine is plugged in if the scene contains objects with physics enabled. You can manually disable physics by setting the Enable Physics option on the Scene - > Physics panel to OFF. You can also uncheck the Use Physics flag on the [project configuration page](#) in the [Project Manager](#) to exclude physics engine files from the build version of your project.

Note: Physics is not supported in WebPlayer HTML type projects and in the scenes exported into HTML.

Several flags for configuring physics engine are available in the `init()` method that is used to initialize the application:

`physics_enabled` - load physics engine to use physics in the application. Set to true by default.

`physics_uranium_path` - the relative path to the folder containing the physics engine files (the uranium_wasm.js, uranium_wasm.wasm, uranium.js and uranium.js.mem files). Use this parameter if you need to place physics engine files in a custom location.

`physics_use_wasm` - if this parameter is set to true, WebAssembly version is used. If it is set to false, the asm.js version is used instead. Default value is true.

`physics_use_workers` - calculate physics in a separate thread using a worker (if this parameter is set to true), or in the main thread (if it is set to false). Default value is true.

For Application Developers

Table of Contents

- For Application Developers
 - Application Development
 - * Application Code Structure
 - Background Transparency
 - Resource Conversion
 - * Commands
 - * Arguments
 - * Dependencies
 - * Data Formats
 - GZIP Compression
 - Code Examples
 - Loading Application Assets
 - Event-Driven Model
 - * Sensors
 - * Example
 - SDK File Structure
 - Loading Local Resources
 - Quality Profiles
 - Non-Standard Canvas Position and Orientation
 - Mobile Web Apps

Application Development

To simplify development process, we recommend to use [Project Manager](#). It can be used to quickly create a simple application with a generic code that is enough to load a simple scene and enable basic camera controls.

Application Code Structure

The process of initializing and loading an application is separated into several stages, which is reflected in the code of the application. If you are using Project Manager, a newly created Copy or Compile type project will include a main JS file, which will be placed in the SDK. The path to the file will look like this: `./projects/PROJECT_NAME/PROJECT_NAME.js`.

This file contains generic code shaped as a module. This module can be registered using the certain structure:

```
b4w.register("my_module", function(exports, require) {

    // module code
    //...

});
```

So, the code of a module is contained within a function that accepts exports and require parameters.

1. `require` is the method used for loading engine modules. The generic example mentioned above loads several modules:

The most important ones of them are the app and data modules. The app module simplifies application initialization while the data module contains API methods for loading 3D scene data.

Note: To make module naming more convenient, `m_` prefix is often used (`m_app`, `m_data` etc.) to show that the variable is an engine module.

2. `exports` is an object used for gaining access to module's functions from outside (for example, from other modules). In this case, only the `init` function has been made external:

```
b4w.register("my_module", function(exports, require) {

    ...

    exports.init = function() {
        m_app.init({
            canvas_container_id: "main_canvas_container",
            callback: init_cb,
            show_fps: DEBUG,
            console_verbose: DEBUG,
            autoresize: true
        });
    }

    ...
```

```
});
```

Application initialization begins with this function, and it is called outside of the module:

```
b4w.register("my_module", function(exports, require) {

  ...

  exports.init = function() {
    m_app.init({
      canvas_container_id: "main_canvas_container",
      callback: init_cb,
      show_fps: DEBUG,
      console_verbose: DEBUG,
      autoresize: true
    });
  }

  ...
});

// import the app module and start the app by calling the init method
b4w.require("my_module").init();
```

After this, the `app.init` method is called. It creates Canvas HTML element and performs all necessary action for initializing WebGL. This method has many different attributes, the most important ones of which are:

- `canvas_container_id` set the id of the HTML element that acts as a container for the Canvas element. By default, an element with the `main_canvas_container` ID is used (this element is located in the main HTML file of the application).
- `callback` is the function that is called after finishing initialization.

When application initialization is completed, the `init_cb` function set by the `callback` parameter is called:

```
function init_cb(canvas_elem, success) {

  if (!success) {
    console.log("b4w init failure");
    return;
  }

  m_preloader.create_preloader();

  // ignore right-click on the canvas element
  canvas_elem.oncontextmenu = function(e) {
    e.preventDefault();
    e.stopPropagation();
    return false;
  };
};
```

```
load();
}
```

It has following parameters:

- `canvas_elem` is the created Canvas HTML element that will be used for rendering 3D content
- `success` is the flag that indicates the success of the initialization. The false value meant that the application is unable to work due to initialization errors (for example, WebGL is not supported by the device).

Note: The `app.init` methods sets initialization to the `window.onload` event, so the `init_cb` function will have access to the entire DOM tree of the HTML document.

Now we can begin loading 3D scene. This is done in the `load` function that is called from the `init_cb`:

```
var APP_ASSETS_PATH = m_cfg.get_assets_path("my_project");
...
function load() {
  m_data.load(APP_ASSETS_PATH + "my_project.json", load_cb, preloader_cb);
}
```

The `data.load` method is used for loading. The first parameter of this method is the path to a 3D scene file. The path to a JSON file should be relative to the main HTML application file. Projects created in Project Manager have a dedicated asset folder, and you can easily obtain the path to it. This is done in the generic example code by introducing the `APP_ASSETS_PATH` global variable that is later used in the `data.load`.

The second parameter of the method is the `load_cb` function which is called after the 3D scene is loaded and prepared for rendering.

```
function load() {
  m_data.load(APP_ASSETS_PATH + "my_project.json", load_cb, preloader_cb);
}

function load_cb(data_id, success) {

  if (!success) {
    console.log("b4w load failure");
    return;
  }

  m_app.enable_camera_controls();

  // place your code here
```

```
}

```

Calling this function means that the application has finished loading and now starts scene rendering. As this is the very first moment when the 3D scene data will be available, it is a suitable moment for initializing and preparing everything related to the scene, its object, animations and other things. For example, standard camera controls can be enabled here with the `enable_camera_controls` method.

Writing Application Logic

After initializing and loading 3D scene the application will proceed to work according to the logic set by the programmer such as interacting with input devices, manipulating scene objects, controlling camera behavior and so on.

By observing the [application loading process](#), we can determine several places suitable for performing various tasks.

1. The `app.init` method used for starting the initialization accepts engine configuration parameters. So you can configure the engine right before calling this method using URL attributes as a base:

```
b4w.register("my_module", function(exports, require) {
...
exports.init = function() {
  var url_params = m_app.get_url_params();
  if (url_params && "show_fps" in url_params)
    var show_fps = true;
  else
    var show_fps = false;

  m_app.init({
    canvas_container_id: "main_canvas_container",
    callback: init_cb,
    autoresize: true
    show_fps: show_fps
  });
}
...
});
b4w.require("my_module").init();

```

2. Initialization is started by the `window.onload` action, which means that after it is completed, the `init_cb` function will have access to the whole DOM tree. At this moment, you already can perform some preparations such as creating and setting up interface elements. However, the 3D scene itself is not yet loaded, and its objects are not yet available.

3. After the 3D scene is loaded, the `load_cb` function is called. At this moment, all scene objects become available, thus any action that concerns them can be implemented in this function. Some examples can be found in the [Code Snippets](#) application.

Logic can be added to the application by using either browser or engine API:

1. Basic keyboard/mouse/gamepad input can be implemented with standard event handlers by using the `addEventListener` method. In more complex cases you can use the `input` API module. The engine also features the `add_click_listener` method that registers both mouse clicks and touch screen events which makes it useful for writing applications compatible with desktop and mobile devices alike.
2. Time-stretched events that have to be performed at every frame (procedural animation, for example) can be implemented with methods such as `set_render_callback`, `append_loop_cb`, `animate` and `set_timeout`. Standard `setTimeout` and `setInterval` methods can also be used.
3. For complex logic that takes into account both user actions and the state of the 3D scene can use engine's [event-driven model](#) that is based on sensor system.

Module System

Blend4Web engine is built upon modular structure: all engine API methods are separated into several modules. If necessary, a module can be plugged into the application with the `require` method. We recommend to structure the code of the actual application into modules as well.

1. Registering Modules

A module is essentially a code block wrapped by a specific structure that is used to register it:

```
b4w.register("my_module1", function(exports, require) {  
    // module code  
    ...  
});  
  
b4w.register("my_module2", function(exports, require) {  
    // module code  
    ...  
});  
...
```

The `register` method is used for registering modules. You can only register custom modules if their names do not coincide with the regular API modules. If necessary, the `module_check` method to check if a module with a given name is present:

```
if (b4w.module_check("my_module"))
  throw "Failed to register module: my_module";

b4w.register("my_module", function(exports, require) {

  // module code
  ...

});
```

2. Loading Modules

Custom modules, just like regular ones, can be plugged in with the `require` method:

```
b4w.register("my_module1", function(exports, require) {

  var mod2 = require("my_module2")

  ...

});
```

3. Application Initialization

Application initialization in Blend4Web is usually done with a call like this:

```
b4w.require("my_module").init();
```

Here, the `my_module` custom module and its `init` external function do, in a certain sense, act as the entry point to the application.

Note: In the global visibility scope a module can be loaded with the same `require` method available as a method of the global `b4w` object: `b4w.require("MODULE_NAME")`.

4. Using Multiple Modules

After a project is created in the [Project Manager](#), its generic application JS-file will contain only one module. However, while developing the application, you might need to separate your code into several logic parts. In this case, you can either create several modules inside one file, or you can create several files each one of them contain one module.

If your application uses multiple modules, keep in mind that every one of them should be properly registered before initialization starts, or you will get an engine error if you try to call a module that is not yet registered. If you are using several JS files, the script that starts the initialization (contains application entry point) should be the last one to be plugged into the main HTML application file.

Background Transparency

The `background_color` and `alpha` parameters are passed to the `init` method placed in the load callback function (a function that is called right after the scene is loaded), like this:

```
m_app.init ({
  alpha: true,
  background_color: [0.7, 0.7, 0.7, 1]
  //this method sets the background to an opaque light gray color
});
```

The combination of the parameters passed to the method defines how the backgrounds of the Blend4Web application and the HTML application blend together. Available options are:

1. `alpha = false` The color of the background is defined by the `background_color` of the Blend4Web application, the background of the HTML application is not taken into consideration.

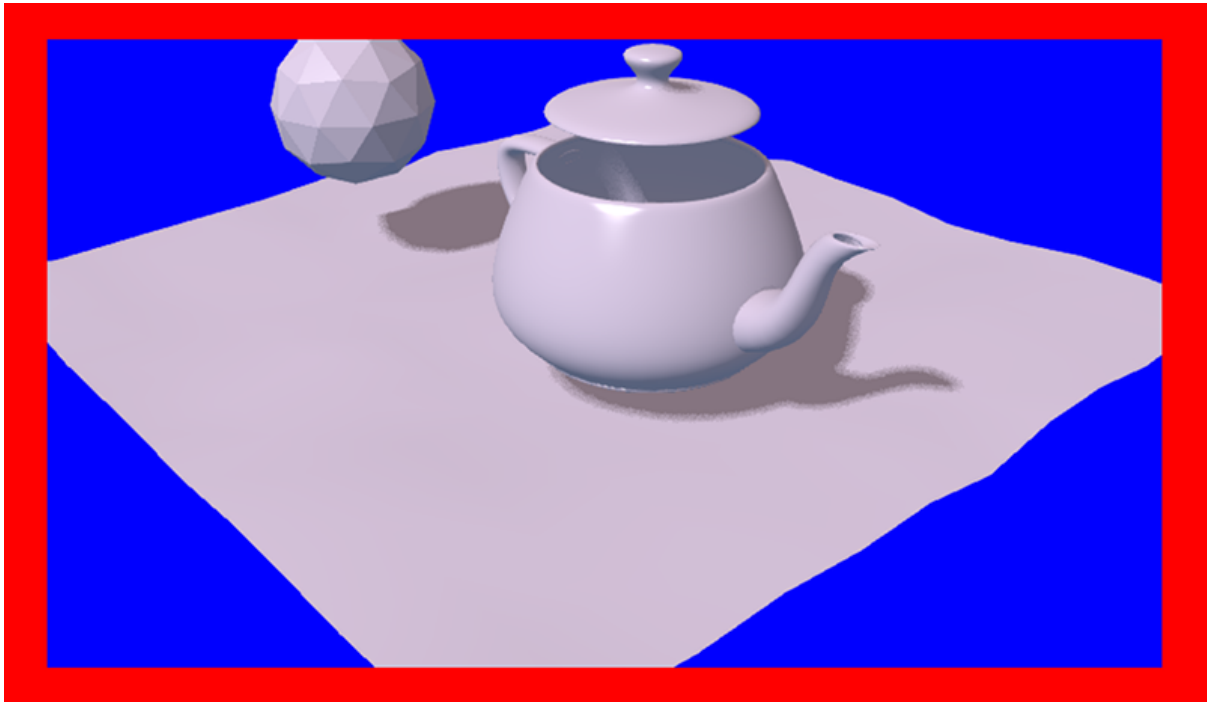

2. `alpha = true` The background of the HTML application might influence the background of the Blend4Web application based on its transparency which is defined by the fourth component of the `background_color` parameter (`alpha = background_color[3]`, not to be confused with the alpha parameter mentioned above).

`background_color[3] = 1` This produces the same result as if the alpha parameter has been turned off (`alpha = false`)

`background_color[3] = 0` Additive blending is used.

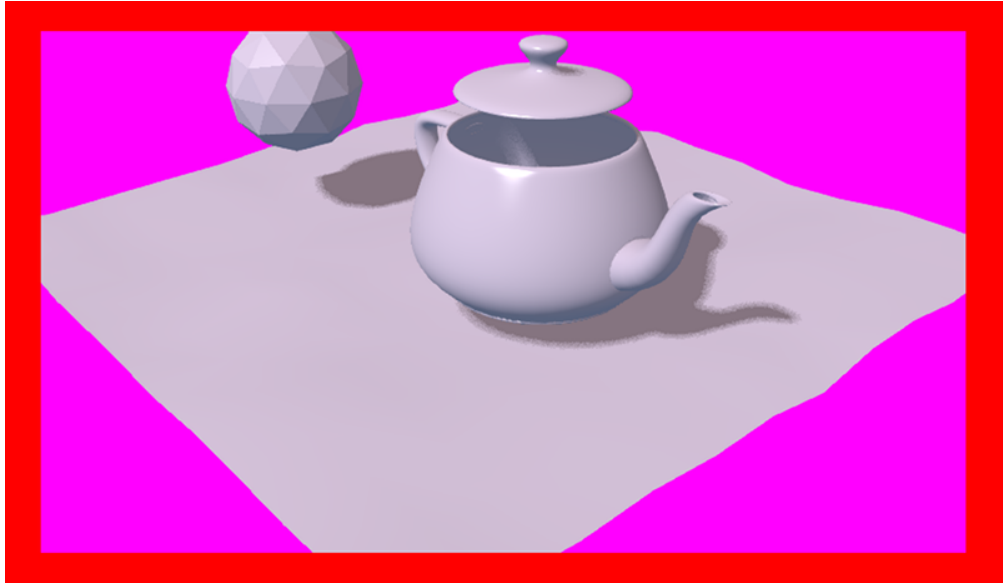

Picture above shows an HTML page containing a Blend4Web application with a blue $[0, 0, 1]$ background that blends with the page's red (Red) color producing a violet tone.

`background_color[3] > 0` Additive blending is used with the `background_color` having a greater influence.

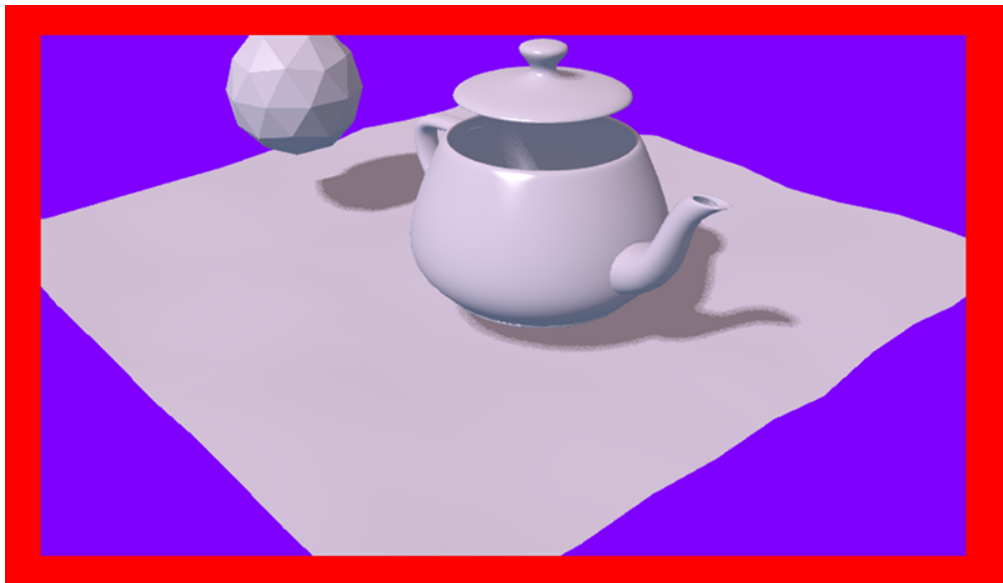

This picture shows the same HTML page with the same Blend4Web app, however, the alpha value is set to 0.5, leading to a darker tone of the application background.

The mechanisms of alpha blending are described in greater detail in the [Color Management](#) chapter.

By default, the alpha parameter is set to true and the `background_color` is set to transparent black $[0, 0, 0, 0]$, which means that the application will have an HTML background with no influences from the background of the Blend4Web application.

Background transparency can also be utilized in [Web Player](#) applications by using the

alpha URL attribute. To use this feature, firstly you need to enable the Background transparency (alpha) parameter in the [Web Player Params](#) group while creating the application.

If Blend4Web application uses sky rendering, the application canvas will be fully covered by objects (including sky), so the background will be fully opaque and not influenced by alpha settings.

Note: Sky rendering is enabled by default in Blend4Web scenes created in [Project Manager](#). Don't forget, in order to use a transparent background you will need to manually disable sky rendering.

Resource Conversion

Currently, browsers do not fully support all possible media formats, so in order to create cross-browser applications (and also for optimization purposes) we recommend you to use the resource converter.

To support a wider range of platforms, a Python script (`scripts/converter.py`) for converting the source files into other formats is included into the distribution.

There are two ways to run this script.

Firstly, you can run it automatically using the project management system. The [Convert Resources](#) button can be found in the main page of the [Project Manager](#), in the [Operations](#) tab at the right side of the screen.

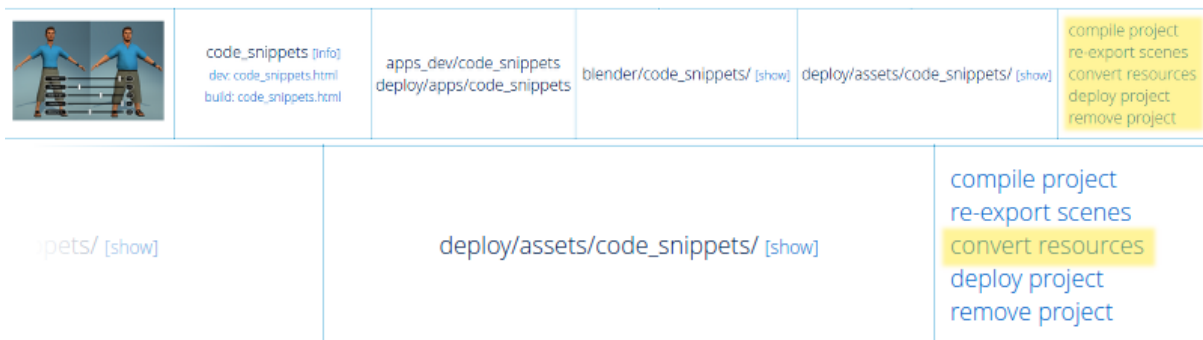

Secondly, you can run the script manually:

```
> cd <path_to_sdk>/scripts
> python3 converter.py [options] resize_textures | convert_dds | convert_media
```

For MS Windows users:

```
cd <path_to_sdk>\scripts
python converter.py [options] resize_textures | convert_dds | convert_media
```

Note: To run the scripts the Python 3.x needs to be installed in your system.

With the `-d` parameter you can specify the path to a directory in which converting will take place.

To exclude some directory from resource conversion, it is enough to put a file named `.b4w_no_conv` in it. This will not affect conversion in nested directories.

The `resize_textures` argument is used for decreasing texture resolution for the LOW mode.

Commands

Commands for conversion:

- `resize_textures` converts textures to lower resolution.
- `convert_dds` converts textures to [DDS format](#).
- `convert_pvr` converts textures to [PVR format](#).
- `convert_media` converts audio and video files to [alternative formats](#).
- `convert_gzip` generates GZIP-compressed versions of ".json" and ".bin" scene files and ".dds" and ".pvr" textures.

Commands for resource cleanup:

- `cleanup_textures` removes low resolution textures generated by the `resize_textures` command.
- `cleanup_dds` removes DDS texture files generated by the `convert_dds` command.
- `cleanup_pvr` removes PVR texture files generated by the `convert_pvr` command.
- `cleanup_media` removes audio and video files in alternative formats that were generated by the `convert_media` command.
- `cleanup_gzip` removes GZIP-compressed files generated by the `convert_gzip` command.

Commands for image compression:

- `compress_png` compresses PNG files in order to decrease their size. This option requires [OptiPNG](#) tool to be installed and set up in the `PATH` environment variable.

Other commands:

- `check_dependencies` checks [converter dependencies](#)

Arguments

- `-d, --dir <dir_path>` enables using an alternative directory to store converted files. The `<dir_path>` value specifies the path to this directory.
- `-j, --jobs <jobs>` specifies the number of jobs (threads) to run simultaneously. If this parameter is set to zero or is not specified, the number will be calculated automatically based on the number of CPUs.
- `-v, --verbose` enables outputting more information about files that are being converted. For example, when converting textures into DDS format, the script will show progress percentage for every file that is being converted.

Dependencies

Please make sure that you have all converter dependencies installed. You can do it with the following command:

```
> python3 <path_to_sdk>/scripts/converter.py check_dependencies
```

If some program is not installed, the following message will be displayed:

Couldn't find PROGRAM_NAME.

Linux

The list of dependencies is listed in the following table:

Name	Ubuntu 16.04 package
ImageMagick	imagemagick
NVIDIA Texture Tools	libnvtc-bin
Libav	libav-tools
FFmpeg	ffmpeg
PVRTC	install manually

Note: Linux users can additionally install the package `qt-faststart` which is used to optimize loading media files.

Windows

For MS Windows users it is not necessary to install these packages since they are already present in the SDK.

macOS

macOS users can install the `brew` package manager first and then install any missing packages.

Before installing packages, install the `libpng` and `libjpeg` libraries using these commands:

```
> brew install libpng
> brew install libjpeg
```

Now you can proceed with installing required dependencies:

```
> brew install imagemagick
> brew install --with-theora --with-libvpx --with-fdk-aac ffmpeg
```

In order to install NVIDIA Texture Tools, clone the repository with the following command:

```
> git clone https://github.com/TriumphLLC/NvidiaTextureTools.git
```

Now you can build and install the package:

```
> cd NvidiaTextureTools
> ./configure
> make
> make install
```

Data Formats

The conversion is performed as follows:

for audio (convert _media):

- ogg (ogv, oga) -> mp4
- mp3 -> oga
- mp4 (m4v, m4a) -> oga
- webm -> m4a

We recommend to use ogg as a base format. In this case the only conversion required for cross-browser compatibility will be ogg to mp4. Example of an input file: file_name.ogg, example of an output file: file_name.altconv.mp4.

for video (convert _media):

- ogg (ogv, oga) -> m4v / seq
- mp3 -> webm / seq
- mp4 (m4v, m4a) -> webm / seq
- webm -> m4v / seq

We recommend to use WebM as a base format. In this case the only conversion required for cross-browser compatibility will be webm to m4v (webm to seq for iPhone). Example of an input file: file_name.webm, example of an output file: file_name.altconv.m4v.

for images (convert _dds):

- png -> dds/pvr
- jpg -> dds/pvr
- bmp -> dds/pvr

- gif -> dds

Example of an input file: file_name.jpg, example of an output file: file_name.altconv.jpg.dds.

For the purpose of optimizing application performance it's possible to use min50 (halved) and DDS or PVRTC (compressed) textures. In order to do this, we need to pass the following parameters during initialization of the application:

```
exports.init = function() {
  m_app.init({
    // ...
    assets_dds_available: true,
    assets_min50_available: true,
    // ...
  });
  // ...
}
```

Note: If you are planning to use textures compressed into PVRTC format, then replace this line of code

```
assets_dds_available: true,
```

with the following:

```
assets_pvr_available: true,
```

This will tell the engine to load PVRTC textures, if such are present in the ./assets/ folder.

DDS Texture Compression

DDS textures require less memory (4 times less for RGBA data and 6 times for RGB data), but using them has following downsides:

- DDS textures might not work on some devices, especially the mobile ones, as not all of them support the WEBGL_compressed_texture_s3tc extension;
- as DDS is a lossy compression format, compression artifacts might be visible, especially on [normal](#) and [stencil](#) maps; it is recommended to [disable compression](#) for such textures.



An example of the DDS compression artifacts, particularly visible on the edges of the shadow.

During exporting the scene from Blender to the JSON format (but not the HTML format), DDS textures will be plugged in automatically, if they are present.

Textures can be converted to the DDS format using the [project manger](#) or the [scripts/converter.py](#) script described above.

PVRTC Texture Compression

PVRTC is another texture compression format used primarily on iOS devices. In some cases it can produce texture files up to two times smaller than same texture images would take in DDS format.

The format has two compression settings that are supported by the engine: 2-bpp (two bits per pixel) and 4-bpp (four bits per pixel).

As with DDS format, textures compressed using the PVRTC algorithm may not work on some platforms, especially mobile, because using this compression format require support for the `IMG_texture_compression_pvrtec` WebGL extension.

The PVRTC library and SDK are available for Windows, Linux and macOS systems alike. Installation packages can be downloaded from the [Power VR Insider](#) web page.

The Blend4Web engine uses a console PVRTC tool. To use it, you need to add the path to it to the `PATH` environmental variable, like the following:

```
export PATH = <InstallDir>\PVRTexTool\CLI\<PLATFORM>\
```

where `<InstallDir>` is the PVRTexTool installation directory and `<PLATFORM>` is a folder that contains the version of the tool that corresponds to your OS, for example, `\Windows_x86_64\` for 64-bit Windows OS.

Note: In Windows systems, environment variables can be set in the System (in Windows 10 and 8) or Properties (in Windows 7 and Vista) dialogue window by choosing Advanced System Settings -> Environment Variables, or by using console commands:

```
SET PATH = <InstallDir>\PVRTexTool\CLI\<PLATFORM>\
```

After this, you will be able to convert the textures to the PVR format by using `converter.py` script with the `convert_dds` command.

SEQ Video Format

The `.seq` file format is used for sequential video. This is applied for IE 11 and iPhone because they are currently missing support for standard video formats for textures. Using `dds` format for images is more optimal compared to other formats.

The engine can use files which are manually created by a user if they have the following names: `file_name.altconv.m4v`, `file_name.altconv.mp3` and so on. Such files should be placed in the same directory as the media files used in Blender.

You can also use the free and cross-platform application [Miro Video Converter](#) to convert media files.

GZIP Compression

Typical Blend4Web application can use various resource formats from standard HTML, JS, CSS, PNG or JPEG files to engine-specific JSON- and BIN-files that contain scene data. Compressed DDS/PVR image formats are also an option. Both big and small applications benefit from decreasing the size of the resources, as this also decreases the loading time.

Usually, loading time can be decreased by setting up caching on the server that contains web application. You can also enable GZIP compression for various file types.

Speaking of the specific file types, GZIP compression should be used for JSON, BIN, DDS and PVR files. JSON and BIN files, being the main scene files, can contain large amounts of data, while DDS and PVR also can be quite large (at least when compared to standard PNG and JPEG files), and there can be quite a lot of them.

But if for some reason GZIP compression cannot be set up on the server, it can be enabled in the application itself.

The engine can load compressed resources in the form of `.gz` files. To use this feature in a WebPlayer JSON type project, you need to pass the `compressed_gzip` URL parameter. If you are developing your own application, you need to pass the `assets_gzip_available` configuration parameter during the initialization.

```
var m_app = require("app");

m_app.init({
  canvas_container_id: "main_canvas_container",
  callback: init_cb,
  show_fps: DEBUG,
```

```
    console_verbose: DEBUG,  
    autoresize: true,  
    assets_gzip_available: true  
});
```

Compressed .gz files should be placed alongside the original ones, for example, like this:

```
my_project/  
  assets/  
    my_scene.json  
    my_scene.json.gz  
    my_scene.bin  
    my_scene.bin.gz
```

This also applies to the .dds and .pvr files and their compressed counterparts .dds.gz and .pvr.gz.

Note: If a compressed .gz is not present, engine will load the original file and output a corresponding message to the console.

GZIP compressed files can be generated with the `convert resources` command that can be found in the Project Manager interface. This can also be done in the console by running the `./scripts/converter.py` script with the `compress_gzip` (for compressing resources) or the `cleanup_gzip` (for removing compressed files) command.

Code Examples

The SDK includes the Code Snippets application which demonstrates how to use the engine's functionality.

Currently, this application contains the following examples:

- Bone API - an example of individual bones position control
- Camera Animation - procedural camera animation
- Camera Move Styles - changing control modes for the camera
- Canvas Texture - working with canvas textures
- Change Image - changing texture images on-the-fly
- Custom Anchors - creating custom annotations
- Dynamic Geometry - procedural geometry modification
- Gamepad - an example of controlling a character via gamepad
- Gyro (Mobile Only) - working with mobile devices' gyroscopes
- Instancing - copying scene objects in runtime

- Leap Motion - an example of using Leap Motion controller
- Lines - procedural lines rendering
- Material API - tweaking material properties and replacing objects' materials
- Morphing - using shape keys
- Multitouch (Mobile Only) - using mobile devices multitouch sensor
- Pathfinding - an example of calculating paths and using navigation meshes
- Ray Test - the usage of raycasting for obstacles detection
- VR - a VR application example
- Webcam - using media stream from a web camera

The Code Snippets application is available at `./apps_dev/code_snippets/code_snippets_dev.html`. It can be also run by using a link in the `index.html` file located in the SDK root.

Loading Application Assets

To simplify project maintenance and server deployment always keep your application asset files (exported scenes, textures, sounds, etc) separate from other project files (JavaScript, CSS, HTML, etc). Inside your SDK this asset directory is located at `projects/my_project/assets`.

To load files (e.g by using `load()`) from this directory use the `get_assets_path()` method:

```
m_data.load(m_config.get_assets_path("my_project") + "loaded_scene.json", load_cb);
```

This way you ensure that your applications will find assets independently of the current development stage (developed, built or deployed).

Event-Driven Model

The event-driven model provides a universal interface for describing the 3D scene's change of state. It simplifies the processing of physics events and user actions.

Sensors

The basic unit of the event-driven model is a sensor. A sensor is a programming entity and can only be active (1, one) or inactive (0, zero). Some sensors may carry a payload which can be received in the manifold's callback function with corresponding API. For example, the ray-tracing sensor (Ray Sensor) provides the relative length of the intersection ray.

Users cannot directly control sensors via the external API. Instead, all sensors must be present in one or multiple collections - so called sensor manifolds. A manifold is a logic container associated with a scene object. It generates a response to a defined set of

sensor events by executing a callback function. To define the manifold it is required to have the following information (see also the API documentation for description of the `controls.create_sensor_manifold` function):

- An object to carry the manifold (e.g. a thrown object).
- A unique id of the manifold (e.g. “IMPACT”).
- Callback execution mode (the options are: `CT_POSITIVE` - logic function positive result, `CT_CONTINUOUS` - every frame with a positive logic function result and once with a zero result, `CT_LEVEL` - any logic, function result change, `CT_SHOT` - one-stage logic function result change, `CT_TRIGGER` - logic function result switch, `CT_CHANGE` - any sensor value change).
- An array of sensors.
- A logic function to define the combination of the sensor states for which the callback function is executed.
- A callback function.
- An optional parameter to pass into the callback function.

You can read more about engine API in the [controls](#) module documentation.

Example

Let’s consider the task to insonify the impact of a thrown stone. A distinctive sound should be produced for impacting different media (for example terrain and wall). There are collision meshes with physical materials in the Blender scene, material ids are “TERRAIN” and “WALL”. There is also a physical object being thrown in the scene, the object is named “Stone”.

Let’s define a collision sensor for each medium, by the type of the sound produced.

```
// import the modules
var m_scenes = b4w.require("scenes");
var m_controls = b4w.require("controls");

// get the object being thrown
var stone = m_scenes.get_object_by_name("Stone");

// create the sensors
var sensor_impact_terrain = m_controls.create_collision_sensor(stone, "TERRAIN");
var sensor_impact_wall = m_controls.create_collision_sensor(stone, "WALL");
```

Add the sensors into an array. Use the OR logic in the logic function. Place the sound processing code in the callback function. Create the sensor manifold with the “IMPACT” id and the `CT_SHOT` type.

```
// array of the sensors
var impact_sens_array = [sensor_impact_terrain, sensor_impact_wall];
```

```

// manifold logic function
var impact_sens_logic = function(s) {return (s[0] || s[1])};

// callback
var impact_cb = function(obj, manifold_id, pulse) {

    // NOTE: it 's possible to play both sounds simultaneously

    if (m_controls.get_sensor_value(obj, manifold_id, 0) == 1) {
        // ...
        console.log("play the terrain impact sound");
    }

    if (m_controls.get_sensor_value(obj, manifold_id, 1) == 1) {
        // ...
        console.log("play the wall impact sound");
    }
}

// create the manifold
m_controls.create_sensor_manifold(stone, "IMPACT", m_controls.CT_SHOT,
    impact_sens_array, impact_sens_logic, impact_cb);

```

When the “Stone” object collides with any physical material of “TERRAIN” or “WALL”, the callback function is executed. Inside this function we get the values of both sensors by their indices in the sensor array (0 - “TERRAIN”, 1 - “WALL”). The sensor value = 1 (active) means that the collision happened with the corresponding physical material. As a result the corresponding sound is produced (the code is not shown).

SDK File Structure

addons

- blend4web Blender addon

apps_dev SDK apps source code

- code_snippets source files of the Code Snippets application

- scripts Blend4Web API usage examples' source files

- dairy_plant source files of the Dairy Plant demo (available only in SDK Pro)

- demos_animation project files of the basic animation demos

- demos_environment project files of the basic environment demos

- demos_interactivity project files of the basic interactivity demos

- demos_materials project files of the basic materials demos

- demos_media project files of the basic media demos

demos_particles project files of the basic particles demos

demos_physics project files of the basic physics demos

demos_postprocessing project files of the basic postprocessing demos

farm source files of the Farm demo (available only in SDK Pro)

fashion source files of the Fashion Show demo (available only in SDK Pro)

flight source files of the Island demo

new_year source files of the New Year 2015 greeting card

project.py script for application developers

space_disaster source files of the Space Disaster app

tutorials source files of the Blend4Web tutorials

victory_day_2015 source files of the V-Day 70 greeting card

viewer the sources files of the Viewer application

webplayer source files of the Web Player app

website source files of applications from the Blend4Web official website

blender source files of the Blender scenes

csrc source code (in C) of the binary part of the engine exporter and of the other utilities

deploy the resource directory for deploying on the server (scene source files, compiled applications and documentation)

api_doc API documentation for developers (built automatically, based on the engine's source code)

apps 3D applications intended for deploying; the directory duplicates apps_dev common Compiled engine files. Shared by all applications from SDK (hence the name).

assets application assets: scenes, textures and sounds

doc the current user manual in HTML format, built automatically from doc_src

webglreport WebGL report application

distfiles distribution builder lists

doc_src source files of the current manual written in reST

index.html and index_assets main SDK webpage files

license files with license texts

Makefile makefile for building the engine, the applications, and the documentation

projects directory for user projects

README.rst README file

scripts scripts

`check_resources.py` script for checking of and reporting about unused resources (images and sounds referenced by the exported files)

`compile_b4w.py` script for building engine code and applications

`converter.py` script which halves the texture dimensions, compresses the textures into the DDS format, converts sound files into mp4 and ogg formats

`custom_json_encoder.py` fork of the json Python module, sorts the keys in reverse order

`gen_glmatrix.sh` script for generating the math module based on the source code of glMatrix 2

`graph.sh` SVG generator for the current scene graph, used for debugging rendering

`make_dist.py` distributions builder script

`memory.sh` script for checking memory (RAM) and video memory (VRAM)

`mod_list.py` script for generating the list of modules to use in new applications

`plot.sh` debugging information graph builder

`process_blend.py` script for automatic reexport of all scenes from the SDK

`remove_alpha_channel.sh` script for removing the images' alpha channel

`screencast.sh` script for screen video recording

`shader_analyzer.py` script starting the local web server which calculates complexity of the shaders

`translator.py` script for building add-on translations

shaders GLSL shaders of the engine**src** main source code of the engine's kernel

`addons` source code of engine add-ons

`ext` source code of the external declarations that form the engine's API

`libs` source code of the libraries

tmp directory for temporary files (e.g. Fast Preview)**tools** various tools for building the engine, apps or convert resources

`converter_utils` binary builds of the tools for resource conversion

`closure-compiler` Google Closure compiler, its externs and their generators

gsl

`compiler` compiler for the engine's GLSL shaders

pegjs grammars of the PEG.js parser generator for implementing the GLSL preprocessor, and also the script for generating the parser modules from these grammars

yuicompressor utility for compressing CSS files

uranium source code and building scripts of the Uranium physics engine (the fork of Bullet)

VERSION contains the current version of the engine

Loading Local Resources

The engine's renderer is a web application and it works when you view an HTML file in a browser. After initialization the resources (scenes, textures) are loaded. This process is subject to the [same-origin policy](#) rule. In particular this rule forbids loading from a local directory.

Since version 15.02, the Blend4Web SDK includes the [development server](#) to solve the problem of loading local resources.

Quality Profiles

Several quality profiles are implemented in order to support platforms with different functionality.

- low quality (P_LOW) - a range of functions is turned off (such as shadows, dynamic reflection, postprocessing), the size of textures is halved when using a release version, anti-aliasing is disabled
- high quality (P_HIGH) - all features requested by the scene are used, the anti-aliasing method is FXAA
- maximum quality (P_ULTRA) - rendering resolution is doubled, resolution of shadow maps is increased, the anti-aliasing method is FXAA (uses higher quality settings and works slower).
- custom quality (P_CUSTOM) - any quality parameter can be set to any possible value. This option is used when you need to set certain quality parameters manually. By default, it uses the same settings as High quality profile.



Switching the quality profiles can be performed in runtime before initialization of the WebGL context. The default profile is P_HIGH.

```
var m_cfg = b4w.require("config");
var m_main = b4w.require("main");

m_cfg.set("quality", m_cfg.P_LOW);
m_main.init(...);
```

Application developers can also set the quality parameter upon engine initialization using the app.js add-on:

```
var m_cfg = b4w.require("config");
var m_app = b4w.require("app");

m_app.init({
  canvas_container_id: "body_id",
  quality: m_cfg.P_HIGH
});
```

Non-Standard Canvas Position and Orientation

The Canvas element, to which the rendering is performed, can change its position relative to the browser window. This can occur due to some manipulations over the DOM tree, or as a result of page scrolling which is especially relevant for non-fullscreen web applications.

In most cases this will not affect the performance of the app by any means. However, some DOM events related to mouse cursor or touch position may carry incorrect information. This occurs because the coordinates obtained from the corresponding events are measured relative to the origin of the browser window, while the engine works with the coordinate space of the Canvas element itself (its origin is located in the top left corner).

1. If the top left corner of the Canvas element matches the top left corner of the browser window and is fixed in its position (non-movable) then it's sufficient to use `event.clientX` and `event.clientY` coordinates of the input events or `get_coords_x()` and `get_coords_y()` methods.

```
var m_mouse = require("mouse");

// ...
var x = event.clientX;
var y = event.clientY;
// ...
var x = m_mouse.get_coords_x(event);
var y = m_mouse.get_coords_y(event);
// ...
```

2. In the case of more sophisticated manipulations with the Canvas element (scrolling of the page elements, displacement from the top level corner of the browser window, changes in the DOM-tree) it's needed to obtain properly calculated coordinates. This can be done by using the aforementioned `get_coords_x()` and `get_coords_y()` methods with a true value as a third parameter:

```
var m_mouse = require("mouse");

// ...
var x = m_mouse.get_coords_x(event, false, true);
var y = m_mouse.get_coords_y(event, false, true);
// ...
```

Another option in this case is to use the `client_to_canvas_coords()` method as follows:

```

var m_cont = require("container");

var _vec2_tmp = new Float32Array(2);

// ...
var coords_xy = m_cont.client_to_canvas_coords(event.clientX, event.clientY, _vec2_tmp);
// ...

```

Mobile Web Apps

An option to scale the whole webpage and change the orientation of a mobile device should be considered when creating user interface for a web application. It is recommended to prevent scaling and keep the aspect ratio of a webpage constant to avoid possible problems. This can be achieved by adding the following meta-tag to the page header:

```
<meta name="viewport" content="width=device-width, initial-scale=1.0, user-scalable=no">
```

Sometimes you might need to lock a mobile device to a certain orientation, especially when you don't want to make both landscape and portrait interface variants. Since the native screenlock API is experimental and isn't widespread, this might be easier to do using CSS rules.

To keep the orientation in landscape mode only, one can set rotation for the `<html>` element by 90 degrees in the portrait mode:

```

@media (orientation : portrait) {
  html {
    position: absolute;
    width: 100vh;
    height: 100vw;
    overflow: hidden;

    -moz-transform: rotate(90deg);
    -ms-transform: rotate(90deg);
    -webkit-transform: rotate(90deg);
    transform: rotate(90deg);
    -moz-transform-origin: top left;
    -ms-transform-origin: top left;
    -webkit-transform-origin: top left;
    transform-origin: top left;

    left: 100%;
  }
}

```

Similarly, the CSS rule for the portrait mode only should look like the following:

```
@media (orientation : landscape) {  
  html {  
    position: absolute;  
    width: 100vh;  
    height: 100vw;  
    overflow: hidden;  
  
    -moz-transform: rotate(-90deg);  
    -ms-transform: rotate(-90deg);  
    -webkit-transform: rotate(-90deg);  
    transform: rotate(-90deg);  
    -moz-transform-origin: top left;  
    -ms-transform-origin: top left;  
    -webkit-transform-origin: top left;  
    transform-origin: top left;  
  
    top: 100%;  
  }  
}
```

For Engine Developers

Table of Contents

- For Engine Developers
 - Coding Style
 - * Examples
 - Building the Engine
 - Building the Add-on
 - Dependencies
 - Naming Functions and Variables
 - Debugging
 - Shader Compilation
 - * Validation
 - * Obfuscation
 - * Optimization
 - * Import/Export Directives
 - * Recommendations and Limitations
 - * WebGL Extensions
 - * Compilation Errors
 - Updating Add-on Translations

Coding Style

This engine uses structural programming. The code is organized in modules. OOP methods are not used, classes are not defined, inheritance is not performed and so on.

The K&R style is used except for the fact that the opening bracket for a compound operator is placed on the same line, for example:

```
function foo_bar() {  
    // ...  
}  
  
if (a > b) {
```

```
} // ...
```

4 spaces are used for indentation (no tabs allowed).

Examples

The underscore symbol is used in function and variable names:

```
var foo_bar = 123; // correct
var fooBar = 123; // wrong
```

All global variables begin with an underscore:

```
var _foo_bar = null;
```

The constants are written in capital letters and never begin with an underscore:

```
var FOO_BAR = 100;
```

The names of external API methods and properties are written after a point. To avoid obfuscation of fields they must be listed with the @cc_externs tag:

```
exports.FOO_BAR = 123;

exports.foo_bar = function() {

}

/**
 * Set properties.
 * @method module:properties.set_props
 * @param {Object} foo Foo object
 * @cc_externs props_1 props_2
 * @cc_externs props_3 props_4
 */
exports.set_props = function(foo) {

    var bar_1 = foo.props_1;
    var bar_2 = foo.props_2;
    var bar_3 = foo.props_3;
    var bar_4 = foo.props_4;

    ...

}
```

Commenting is in English only. Comment style - JSDoc.

Building the Engine

Before building please make sure that your system has all required dependencies installed (see the [table](#)).

To compile the engine and the applications included into the SDK please execute the following command (in the SDK root):

```
make compile
```

The full building that includes converting resources (textures, sounds and videos), compilation and converting the docs, can be performed with the following command:

```
make build
```

Building the archives with the distributions:

```
make dist
```

All above mentioned operations can be performed with a single command:

```
make all
```

Building the Add-on

Binary Blend4Web addon builds are available for the following platforms: Linux x32/64, macOS x64, Windows x32/64. At the same time users can compile the addon by themselves.

To do this Python 3.x (it's better if it's the same version as in Blender) and a C compiler are required. Under Linux it's enough to install the `python3-dev` and `build-essential` packages.

Paths relative to the repository root:

- build script: `csrc/b4w_bin/build.py`
- Blend4Web addon: `addons/blend4web/`

The building process is started in the following way:

```
python3 ./csrc/b4w_bin/build.py
```

As a result of the building you'll get a binary file called:

`b4w_bin_[PLATFORM]_[ARCHITECTURE].[STANDARD_EXTENSION]`,

located in the same directory as the addon. Example: `b4w_bin_Linux_64.so`. After this the addon is ready to use under this platform.

Dependencies

All dependencies are listed in the table below in order of decreasing importance.

Name	Ubuntu 16.04 package	Purpose
Bash	included by default	script interpreter
Python 3	included by default	script interpreter
NodeJS	nodejs	compiling shaders
Java	default-jre	compiling and obfuscating the engine modules
ImageMagick	imagemagick	converting textures
NVIDIA Texture Tools	libnvt-bin	converting textures
Libav	libav-tools	converting media resources
NVIDIA Cg Toolkit	nvidia-cg-toolkit	debugging shaders
OptiPNG	optipng	optimizing PNG files
Emscripten	from EMSDK source code	building Uranium
Gnuplot	gnuplot	debugging
Graphviz	graphviz	debugging
xsel	xsel	debugging
Sphinx	python3-sphinx	building the manual
sphinx-intl	installed with PIP v3 (pip3 install sphinx-intl)	building the manual (internationalization)
TeX Live	texlive texlive-latex-extra texlive-lang-cyrillic texlive-lang-chinese texlive-xetex	building the manual (PDF version)
JSDoc 3	installed with NPM (npm install -g jsdoc)	building the API documentation
PEG.js	from PEG.js source code	building shader preprocessor

Naming Functions and Variables

When creating new functions and variables it is recommended to use the following prefixes and suffixes.

`init_` create an abstract object

`create_` create a certain object

`update_` update the state of an existing object

`attach_/detach_` add/remove a temporary object property

`append_/remove_ add/remove` a temporary property to the already existing properties of the same kind

`insert_/pop_ add/remove` an array element (accessed by index)

`switch_ switch` flag's binary value

`apply_/clear_ operation` with flags, binary values or arbitrary parameters

`set_/get_ set/get` the property/variable value

`_tmp` global variable - cache in the form of a simple object (array, vector)

`_cache` global variable - cache in the form of a complex object

Debugging

Engine debugging is performed with the `debug.js` module methods.

The structure of the current render graph can be saved in the DOT format using the `b4w.debug.scenegraph_to_dot()` call, for example, in the browser console. After calling this method, save the console output into the file with the `.gv` extension. To get the graph in a visual form the `graphviz` utilities are required. Converting to the SVG format is performed using the command:

```
> dot -Tsvg graph.gv -o graph.svg
```

where `graph.gv` is the name of the file with the saved graph.

Shader Compilation

All shaders used in the engine are processed by a compiler. The compiler performs the following three main procedures:

- validation of the shader code,
- its obfuscation and
- optimization.

In order to run the compiler, execute one of the following commands in the SDK root:

```
> make compile_shaders
> make verify_shaders
```

- `make compile_shaders` - performs validation, obfuscation, optimization and finally, export of the compiled shaders,
- `make verify_shaders` - performs only validation, obfuscation and optimization.

Syntax analysis (parsing) of the shader text is first performed during compilation. The corresponding parser is created automatically based on the grammar, using the `PEG.js`

generator. Then the shaders are validated, obfuscated and optimized according to the parser data, and after that the shaders are exported in the form of an abstract syntax tree (AST) for direct loading in the engine.

The location of the main files in the repository:

- initial grammar - `gsls_utils/pegjs/gsls_parser.pegjs`
- parser generation script - `gsls_utils/pegjs/gen_nodejs.sh`
- parser - `gsls_utils/compiler/gsls_parser.js`

Validation

The compiler performs the following procedures related to shader code validation:

- reporting about unused variables and functions (dead code),
- checking the syntax of shaders,
- checking the conformance of shaders to the import/export mechanism,
- removing odd or repetitive tokens: spaces, line ends and semicolons.

Obfuscation

Obfuscation minifies the GLSL code and makes it difficult to understand it. So far the following procedure is implemented:

- replacing the user-defined identifiers with shorter single-symbol, two-symbol etc. names (with support of the import/export mechanism).

Optimization

Optimization constitutes the following procedures:

- removing curly brackets which are not useful in any ways except creating local scopes (this functionality is used for processing `node/lamp` directives),
- optimization inside functions - creating shared local variables to replace ones originally created by the programmer.

An example of removing unused curly brackets: replacing the following code

```
void function(){
  int a;
  {
    a = 1;
  }
}
```

with this code

```
void function(){
    int a;
    a = 1;
}
```

Low number of temporary local variables is achieved by repetitively using them in different contexts. For example, the following code

```
int function(){
    int a = 1;
    int b = a + 3;
    return b;
}
```

will be replaced with

```
int function(){
    int _int_tmp0 = 1;
    _int_tmp0 = _int_tmp0 + 3;
    return _int_tmp0;
}
```

Note: Local variables for structures and arrays are not optimized this way.

Import/Export Directives

import/export directives are used to organize, structure and increase the readability of the shader code in the include file. They are specified in the beginning of the file and should look approximately like this:

```
#import u_frame_factor u_quatsb u_quatsa u_transb u_transa a_influence
#import qrot

#export skin
```

The `#import` directive defines a set of ids which are declared outside the include file but can be accessed from inside it. There is a limitation though: such ids must necessarily be declared somewhere above the place where the include file is linked.

The `#export` directive defines a set of ids which can be accessed from outside this file. Such ids must necessarily be declared in this file.

Therefore, the shader which uses the include file must have all the declarations necessary for import before the place of linking, and can use the exported ids after it.

Ids can be both variable names and function names. If there are no import/export directives it's considered by default that the include file does not use external declarations and does not allow the using of internal ones.

Recommendations and Limitations

Because of the following reasons: preprocessing, the need to process multiple shaders and include files and due to the compiler's features - its possible to guarantee the work of the output code only if a number of rules and limitations are respected with regard to the shader source code:

1. In order to describe constants which are defined by the engine at run, it's necessary to use the `#var` special directive. For example:

```
#var AU_QUALIFIER uniform
AU_QUALIFIER float a;
```

The syntax here is similar to the `#define` directive. The point of the `#var` directive is that the value which it defines allows to parse the initial shader. It's irrelevant what exactly it will be (e.g. 'uniform' or 'attribute' in the above example), because at this level it's unknown anyway. Nevertheless, it's better to specify a more or less suitable description and not something arbitrary.

Note: The `#var` directive is not necessary for constants used not in the shader code but in the preprocessor expressions.

2. Using the `import/export` directives when needed.
3. The built-in functions must not be overloaded - only the user ones.
4. Variables should not be declared with names of the built-in functions, or `main` (even if it doesn't lead to errors).
5. The `#var` and `#define` directives must not be used for replacing single symbols in such operators as: `++`, `--`, `*=`, `/=`, `+=`, `-=`, `=`, `<=`, `>=`, `!=`, `&&`, `||`, `^^`.

For example:

```
#var EQUAL =
...
a *EQUAL b;
...
```

6. The usage of the `#include` directive should not lead to ambiguity during the obfuscation of the include file. This can happen when multiple shaders are included into the same file and the above defined directives (like `#var` or `#define`) can have influence on any of them. Also, it's better not to use undeclared functions and variables in the include file.
7. Multi-level includes or multiple inclusion of the same include into the same shader is not supported.
8. Shader malfunction can also be caused by nontrivial using of preprocessing, for example, creating an invalid GLSL code:

```
#if TYPE
void function1() {
#else
void function1(int i) {
#endif
    ...
}
```

9. Do not declare variables with such names as `node_[NODE_NAME]_var_[IN_OUT_NODE]`, where `NODE_NAME` — name of some node, `IN_OUT_NODE` — name of an input or an output of the node.
10. Repetitive use of `#nodes_main`, `#nodes_global` or `#lamps_main` directives is not permitted inside a single shader.
11. The `#nodes_main`, `#nodes_global` and `#lamps_main` directives are recommended to use in the file, containing these shader nodes description, for example, in the same include-file. This is necessary for the correct shader validation.

WebGL Extensions

Compilation may depend on WebGL extensions being used if they somehow influence the shading language. At the moment the following extensions are supported by the compiler:

- `OES_standard_derivatives`

Compilation Errors

In case of an error the compiler will output the corresponding message in the console.

Table of possible errors:

Error message	Cause
Error! Ambiguous obfuscation in include file 'FILE_NAME'.	Ambiguous obfuscation in the 'FILE_NAME' include file.
Error! Extension NAME is unsupported in obfuscator. File: 'FILE_NAME'.	The NAME WebGL extension used in the FILE_NAME file is not supported by the obfuscator.
Error! Include 'FILE_NAME' not found.	The FILE_NAME include file could not be found.
Error! Undeclared TYPE: 'NAME'. File: 'FILE_NAME'.	Error in FILE_NAME file. Undeclared identifier NAME of type TYPE (variable, function, structure etc).
Error! Undeclared TYPE: 'NAME'. Importing data missed. File: 'FILE_NAME'.	Undeclared identifier NAME of type TYPE (variable, function, structure etc). Declaration missing for the identifier required in the FILE_NAME include file according to the #import directive.
Error! Undeclared TYPE: 'NAME'. Possibly exporting needed in include file 'INCLUDE_NAME'. File: 'FILE_NAME'.	Error in FILE_NAME file. Undeclared identifier NAME of type TYPE (variable, function, structure etc). Possibly its export into the INCLUDE_NAME include file should be allowed.
Error! Undeclared TYPE: 'NAME'. Possibly importing needed. File: 'FILE_NAME'.	Undeclared identifier NAME of type TYPE (variable, function, structure etc). Possibly it should be specified as imported in the FILE_NAME include file.
Error! Unused export token 'NAME' in include file 'FILE_NAME'.	Undeclared identifier NAME is allowed for export in the FILE_NAME include file.

Error! Using reserved word in TYPE 'NAME'. File: 'FILE_NAME'.	Error in FILE_NAME file. A reserved id is used for declaring the identifier NAME of type TYPE (variable, function, structure etc).
Error! 'all' extension cannot have BEHAVIOR_TYPE behavior. File: 'FILE_NAME'.	The #extension directive specified for all WebGL extensions in the FILE_NAME file does not support the behavior BEHAVIOR_TYPE.
Syntax Error. ERROR_MESSAGE. File: FILE_NAME, line: LINE_NUMBER, column: COL_NUMBER.	Syntax error in line LINE_NUMBER column COL_NUMBER during parsing the FILE_NAME shader. The initial error description is quoted in the ERROR_MESSAGE. The code listing taken from around the corresponding line is attached to the message (note the peculiarity of pegjs parser which specify the line which is a little bit after the actual error.
Warning! Function 'NAME' is declared in [include]file FILE_NAME, but never used.	An unused function NAME is declared in the FILE_NAME file.
Warning! Include file 'FILE_NAME' not used in any shader, would be omitted!	The FILE_NAME include file is not used in any of the shaders and so it will be excluded from the obfuscated version.
Warning! Unused import token 'NAME' in include file 'FILE_NAME'.	An unused id NAME is imported in the FILE_NAME include file.
Warning! Variable 'NAME' is declared in include file FILE_NAME, but never used.	An unused variable NAME is declared in the FILE_NAME file.

Updating Add-on Translations

If you need to update all existing .po files, run the script translator.py in the SDK/scripts directory without arguments:

```
> python3 translator.py
```

In order to update an existing .po file, run the script with a supported language code as an argument:

```
> python3 translator.py ru_RU
```

In order to view the list of supported languages, run the script as follows:

```
> python3 translator.py help
```

In any case, the file empty.po will be updated upon running the script.

After updates, the .po files can be edited/translated as usual.

Team Work. Using Git

Table of Contents

- Team Work. Using Git
 - Overview
 - Typical Workflow
 - Individual Settings
 - Checking the Status
 - Before the Commit
 - * Checking changes (of the text files)
 - * Rolling back files
 - * Unwanted files
 - Preparing for Commit
 - * Adding files
 - * Removing files
 - Commit
 - Syncing Between Repositories
 - * From the remote - to the local
 - * From the local - to the remote
 - Resolving Conflicts
 - * Overview
 - * The steps to be taken
 - * Binary files
 - * Text files
 - * Correcting commit
 - Tags
 - Other Useful Commands

Overview

In order to organize team work a Git version control system can be used. Using Git has a number of benefits as compared with other ways to collaborate:

- saving the history of changes with the possibility to roll back to previous versions
- synchronizing changes between users and automatic merging of changes
- working with large binary files is possible

Git is a distributed system and every developer or designer has his own local repository (storage). Syncing between the local repositories can be performed via the central (“shared”) storage, which can be located on a dedicated machine (server). Access to the server can be organized through SSH protocol.

Although there are many GUIs for Git beginners, here the work with the git standard console utility is explained.

Typical Workflow

1. Files can be created, added or deleted during the work process in the local repositories.
2. After a certain logical period of work is finished it is necessary to fix (commit) the changes and/or synchronize with your team mates.
3. Files are prepared for commit i.e. the accounting of changed, new and deleted files and also the resetting of changes.
4. Commit is performed.
5. Local changes are uploaded into the shared storage and become available for the colleagues.

A limited set of Git commands recommended for authoring applications and their graphical resources is described below.

It’s necessary to switch to the repository before executing the commands, e.g.:

```
> cd ~/blend4web
```

Individual Settings

A new user can set up his name and email using the commands:

```
> git config --global user.name "Ivan Petrov"  
> git config --global user.email ipetrov@blend4web.com
```

The set up data will be used in the changelog.

Checking the Status

It's recommended to check the state of the repository before, in progress and after performing all the operations.

Use this command to check the status:

```
> git status
```

The result of the git status command if all the commits were performed and there are no new files:

```
# On branch master
# Your branch is ahead of 'origin/master' by 2 commits.
#
nothing to commit (working directory clean)
```

Possible result of git status if there are changes. For example the apps_dev/firstperson/firstperson.js and doc_src/git_short_manual.rst files are changed and a new file 123.txt is created:

```
# On branch master
# Changes not staged for commit:
#   (use "git add <file>..." to update what will be committed)
#   (use "git checkout -- <file>..." to discard changes in working directory)
#
#   modified:   apps_dev/firstperson/firstperson.js
#   modified:   doc_src/git_short_manual.rst
#
# Untracked files:
#   (use "git add <file>..." to include in what will be committed)
#
#   123.txt
no changes added to commit (use "git add" and/or "git commit -a")
```

Before the Commit

Checking changes (of the text files)

In case of text files it is recommended to view the introduced changes before performing the commit.

Check what was changed in the whole directory:

```
> git diff
```

or in a specific file only:

```
> git diff apps_dev/firstperson/firstperson.js
```

A possible result of the git diff command for a text file:

```
diff --git a/apps_dev/firstperson/firstperson.js b/apps_dev/firstperson/firstperson.js
index 4381c99..44b3b15 100644
--- a/apps_dev/firstperson/firstperson.js
+++ b/apps_dev/firstperson/firstperson.js
@@ -557,8 +557,9 @@ function enable_camera_control_mode() {
     var cam_view_down = CAMERA_MOVE_UPDOWN * (Math.sin(_passed_time) - 1);

     b4w.camera.translate_view(obj, 0, cam_view_down, cam_view_angle);
-   } else
+   } else {
+     b4w.camera.translate_view(obj, 0, 0, 0);
+   }
}
```

Rolling back files

If the file was changed or deleted but it is necessary to recover it (to the latest committed state) use the command:

```
> git checkout doc_src/git_short_manual.rst
> git checkout 123.txt
```

The introduced changes will be canceled - this is why this command should be performed with caution.

Unwanted files

If a file is listed in the Untracked files (git status), but version control is not needed for it, it should be deleted or moved beyond the working directory.

Preparing for Commit

Adding files

If you are happy with the changes, add the needed changed and/or new files for commit.

```
> git add apps_dev/firstperson/firstperson.js
> git add 123.txt
```

Check the status again:

```
> git status
```

Possible result of the git status command after adding some files with the git add command:

```
# On branch master
# Changes to be committed:
#   (use "git reset HEAD <file>..." to unstage)
#
#   new file:   123.txt
#   modified:  apps_dev/firstperson/firstperson.js
#
# Changes not staged for commit:
#   (use "git add <file>..." to update what will be committed)
#   (use "git checkout -- <file>..." to discard changes in working directory)
#
#   modified:  doc_src/git_short_manual.rst
#
```

You can see that the apps_dev/firstperson/firstperson.js and 123.txt files were added for commit and the doc_src/git_short_manual.rst file was not added. To make things easier it is recommended to either add such files for commit or cancel their changes with the git checkout command.

Removing files

Some files can be marked as deleted from Git after performing the git status command, for example:

```
# On branch master
# Your branch is ahead of 'origin/master' by 2 commits.
#
# Changes not staged for commit:
#   (use "git add/rm <file>..." to update what will be committed)
#   (use "git checkout -- <file>..." to discard changes in working directory)
#
#   deleted:   123.txt
#
no changes added to commit (use "git add" and/or "git commit -a")
```

In this case if deleting the file should be recorded (i.e. enter the commit), perform the git rm command, for example:

```
> git rm 123.txt
```

If the file was deleted by accident and its necessary to recover it, use the git checkout command.

Commit

Perform commit with the command:

```
> git commit
```

A text editor window will show up (for example, nano or vim), in which it's necessary to enter the commit comment in English.

```
GNU nano 2.2.6                               File: .git/COMMIT_EDITMSG

My commit message
# Please enter the commit message for your changes. Lines starting
# with '#' will be ignored, and an empty message aborts the commit.
# On branch master
# Changes to be committed:
#   (use "git reset HEAD <file>..." to unstage)
#
#    new file:   123.txt
#   modified:   apps_dev/firstperson/firstperson.js
#
# Changes not staged for commit:
#   (use "git add <file>..." to update what will be committed)
#   (use "git checkout -- <file>..." to discard changes in working directory)
#
#    modified:   doc_src/git_short_manual.rst
#
^G Get Help          ^O WriteOut         ^R Read File        ^Y Prev Page
^X Exit              ^J Justify          ^W Where Is         ^V Next Page
```

Save the changes and quit the editor (in nano Ctrl+O, then Ctrl+X; in vim ZZ, or ESC :wq).

After commit it's recommended to recheck the status. Commit is performed correctly if the git status command returns nothing to commit, working directory clean.

Syncing Between Repositories

From the remote - to the local

After all the commits are performed it's necessary to load the changes from the remote ("shared") repository to the local one:

```
> git pull
```

Result of the git pull command if there are no changes in the remote repository:

```
Already up-to-date.
```

Result of the git pull command if the remote repository contains changes and syncing was successful:

```
remote: Counting objects: 151, done.
remote: Compressing objects: 100% (101/101), done.
remote: Total 102 (delta 74), reused 0 (delta 0)
Receiving objects: 100% (102/102), 69.77 MiB | 4.87 MiB/s, done.
Resolving deltas: 100% (74/74), completed with 32 local objects.
From lixer:blend4web
   dbf3877..9f9700c master -> origin/master
Updating dbf3877..9f9700c
Fast-forward
 apps_dev/firstperson/firstperson.js      | 338 +--
 .../location_agriculture.blend           | Bin 25601626 -> 25598644 bytes
 ...
 src/controls.js                          | 38 +-
 src/data.js                              | 5 +
 src/physics.js                           | 185 +-
19 files changed, 1452 insertions(+), 2767 deletions(-)
create mode 100644  deploy/assets/location_agriculture/textures/rotonda_02_diff.png
```

If you wish it's possible to look up the changes made by your colleagues using the following command:

```
> git diff dbf3877..9f9700c
```

The parameter of this command - in this case dbf3877..9f9700c - shows between which commits exactly the changes were made. This parameter can be conveniently selected in the console in the git pull results and pasted with a mouse click (middle button) where you need.

You can also view the changelog:

```
> git log
```

The git pull command does not always lead to a successful synchronization. The result of git pull when there are conflicts:

```
remote: Counting objects: 11, done.
remote: Compressing objects: 100% (6/6), done.
remote: Total 6 (delta 5), reused 0 (delta 0)
Unpacking objects: 100% (6/6), done.
From lixer:blend4web
   ff715c2..dbf316a master -> origin/master
warning: Cannot merge binary files: blender/landscape_objects/Fallen_tree.blend (...)

Auto-merging blender/landscape_objects/Fallen_tree.blend
CONFLICT (content): Merge conflict in blender/landscape_objects/Fallen_tree.blend
Automatic merge failed; fix conflicts and then commit the result.
```

The steps to be taken at conflicts are described below.

From the local - to the remote

After that the changes should be uploaded from the local repository to the remote (“shared”) one to make the changes available for team mates.

```
> git push
```

The result of the git push command if the remote repository already contains all the local changes:

```
Everything up-to-date
```

The result of the git push command if synchronization was successful:

```
Counting objects: 25, done.
Delta compression using up to 8 threads.
Compressing objects: 100% (14/14), done.
Writing objects: 100% (14/14), 1.23 KiB, done.
Total 14 (delta 11), reused 0 (delta 0)
To gfxteam@lixer:blend4web.git
 9f9700c..fa1d6ac master -> master
```

The result of the git push command if synchronization was not successful because the git pull command was not executed first:

```
To gfxteam@lixer:blend4web.git
 ! [rejected]      master -> master (non-fast-forward)
error: failed to push some refs to 'gfxteam@lixer:blend4web.git '
To prevent you from losing history, non-fast-forward updates were rejected
Merge the remote changes (e.g. 'git pull ') before pushing again. See the
'Note about fast-forwards' section of 'git push --help' for details.
```

You should execute the git pull command.

The changes uploaded into the central repository can be received by other developers with the git pull command.

Resolving Conflicts

Overview

Synchronization conflicts occur if both conditions are met

1. the same file was changed both in the local and remote repositories, and
2. automatic merging of the changes didn't occur because the changes are in the same place of the file.

Typical cases:

1. a binary file (texture, blend file) was independently changed by two developers
2. different changes were introduced to the same line of the same text file
3. one developer has changed the file while the other has moved it and so on.

Although synchronization conflicts are normal, if they happen too often it slows down the work. It is recommended to notify your team mates about start of working with the shared binary files, and also to perform synchronization more often. It is necessary to effectively distribute the work between developers to reduce the number of such shared files. This can be achieved particularly through linking of all the scene's resources from the separate blend files into the master file.

The steps to be taken

It's not recommended to perform any files operations (modifying, deleting) while the repository is in a conflict state.

The first thing to do is to perform the git status command.

```
# On branch master
# Your branch and 'origin/master' have diverged,
# and have 7 and 1 different commit each, respectively.
#
# Unmerged paths:
# (use "git add/rm <file>..." as appropriate to mark resolution)
#
# both modified:   blender/landscape_objects/Fallen_tree.blend
#
no changes added to commit (use "git add" and/or "git commit -a")
```

A list of conflicting files can be found in the Unmerged paths section.

The order of the following steps is different for binary and text files.

Binary files

At this stage the conflicting binary files are in the same state as they were in the local repository before the synchronization attempt. The files are fully functional (for example they can be opened by graphics editors).

In case of conflicting binary files it's necessary to sort out (with the team mates or by yourself) which of the files should be left and which should be discarded. Selecting can be performed with the git checkout command.

Select the local version of the file (- -ours). To make sure that it's local you can open it.

```
> git checkout --ours blender/landscape_objects/Fallen_tree.blend
```

Select the remote version of the file (- -theirs). To make sure that it's remote you can open it.

```
> git checkout --theirs blender/landscape_objects/Fallen_tree.blend
```

Select the local version of the file again (- -ours).

```
> git checkout --ours blender/landscape_objects/Fallen_tree.blend
```

Eventually you have to stick to the right version of the file. In case there is a threat of losing the work you may save the discarded file outside the repository.

Text files

At this stage Git introduces both local and remote changes to the conflicting text files, in a special format. Such text files are not workable as a rule

Example. One developer changed the scene name from “Blue Lizard” to “Green Lizard” in the application file and uploaded the changes into the central repository. Another developer changed “Blue Lizard” to “Red Lizard” in the same line, performed commit and executed the git pull command. As a result this very developer will be responsible for resolving the conflict. The following lines will be present in his version of the application file:

```
<<<<<<<< HEAD
    "name": "Red Lizard",
=====
    "name": "Green Lizard",
>>>>>>> 81bf4e2d5610d500ad4d2a2605ee7e61f759f201
```

In case of conflicting text files the following steps can be taken. Files with source code should be edited with or without respect to the changes introduced by both parties. On the other hand, it is easier to reexport the exported scene text files (ending with .json).

Correcting commit

After selecting the required files or editing the changes, add them for commit:

```
> git add blender/landscape_objects/Fallen_tree.blend
> git status
```

Possible result of git status command after adding the conflicting files for commit:

```
# On branch master
# Your branch and 'origin/master' have diverged,
# and have 7 and 1 different commit each, respectively.
#
nothing to commit (working directory clean)
```

Perform commit. It is recommended to leave the default comment:

```
> git commit
> git status
```

```
# On branch master
# Your branch is ahead of 'origin/master' by 8 commits.
#
nothing to commit (working directory clean)
```

Conflicts are resolved, the changes from the remote repository are successfully applied in the local repository. Now the changes in the local repository - including the just resolved conflict - can be uploaded to the remote repository with the git push command.

Tags

Tags are intended for pointing at a certain commit, for example, to specify a stable product version.

View the list of tags:

```
> git tag
```

Create a tag for the release from June 3, 2013, pointing to the commit with a stable product version:

```
> git tag R130603 67bb597f7ed1643ed0220d57e894f28662e614e5
```

Check the commit tag information:

```
> git show --shortstat R130603
```

Roll back to the tag...

```
> git checkout R130603
```

...and return:

```
> git checkout master
```

Synchronize the tags with the remote repository:

```
> git push --tags
```

Delete the tag (if created by mistake):

```
> git tag -d R130603
```

Other Useful Commands

Check the log for January, 2012, show file names without merging commits:

```
> git log --after={2012-01-01} --before={2012-01-31} --name-only --no-merges
```

Problems and Solutions

Table of Contents

- Problems and Solutions
 - WebGL Support
 - Problems Upon Startup
 - WebGL Failed to Initialize
 - More In-Depth Troubleshooting
 - Known Issues

As [WebGL](#) is still a relatively new technology, it may not work perfectly with every combination of software and hardware. This chapter covers common problems that users of the Blend4Web engine may encounter and provides solutions for these problems.

WebGL Support

If you are using a desktop or laptop computer, your system must have a GPU that supports DirectX 9.0c and OpenGL 2.1, such as:

- Nvidia GeForce 6xxx series or higher.
- AMD/ATi Radeon R500 (X1xxx) series or higher.
- Intel GMA 950 or higher.

If you are using WebGL on a mobile device, please check whether your device is on the [compatibility list](#).

You also need to have a web browser that supports WebGL technology.

The following web browsers support WebGL:

- Google Chrome (v. 9 or higher)
- Mozilla Firefox (v 4.0 or higher)
- Safari (v. 8.0 or higher)

- Chrome for Android (v. 25 or higher)
- Internet Explorer (v. 11 or higher)
- Microsoft Edge
- Opera (v. 12 or higher)
- UC Browser (experimental)
- Yandex Browser

We also recommend to use the most recent version of the web browser to avoid compatibility problems.

Problems Upon Startup

1. The “Browser could not initialize WebGL” message is shown.

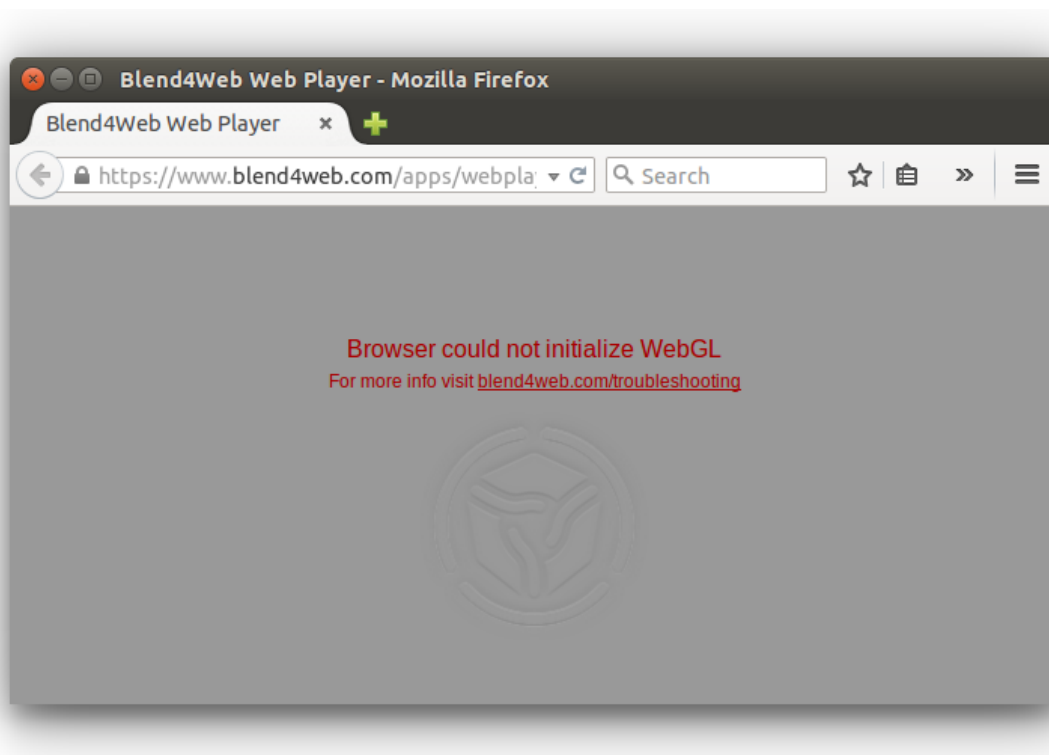

Follow the instructions listed in the [WebGL Failed to Initialize](#) section.

2. The user interface or background is shown but the default scene is not rendered. At the same time the <http://get.webgl.org/> site and other WebGL applications are working correctly.

Possible causes:

- The engine tries to load resource files which were moved or deleted.
- You are using the old versions of video drivers.
- You are using open source drivers which do not fully support WebGL.

For Linux users - due to incomplete OpenGL implementation in open source drivers at the moment it is recommended to use current versions of proprietary drivers for Nvidia and AMD video cards.

- You are using an outdated operating system, such as Windows XP.
- Browser is not set up for loading local resources. In this case, the problem can be fixed by using local web server. See the [Loading Local Resources](#) section.

WebGL Failed to Initialize

The <http://get.webgl.org/> page tells about problems when viewing it in recent Chrome or Firefox. What can I do?

1. Install the latest updates for your system (for MS Windows see [the guide](#)). In case of MS Windows install the latest [DirectX runtime](#). Reboot.
2. It is recommended to timely update video card drivers. To detect your video card and its vendor please type `about:gpu` (or `chrome://gpu`) to the address bar of Chrome browser...

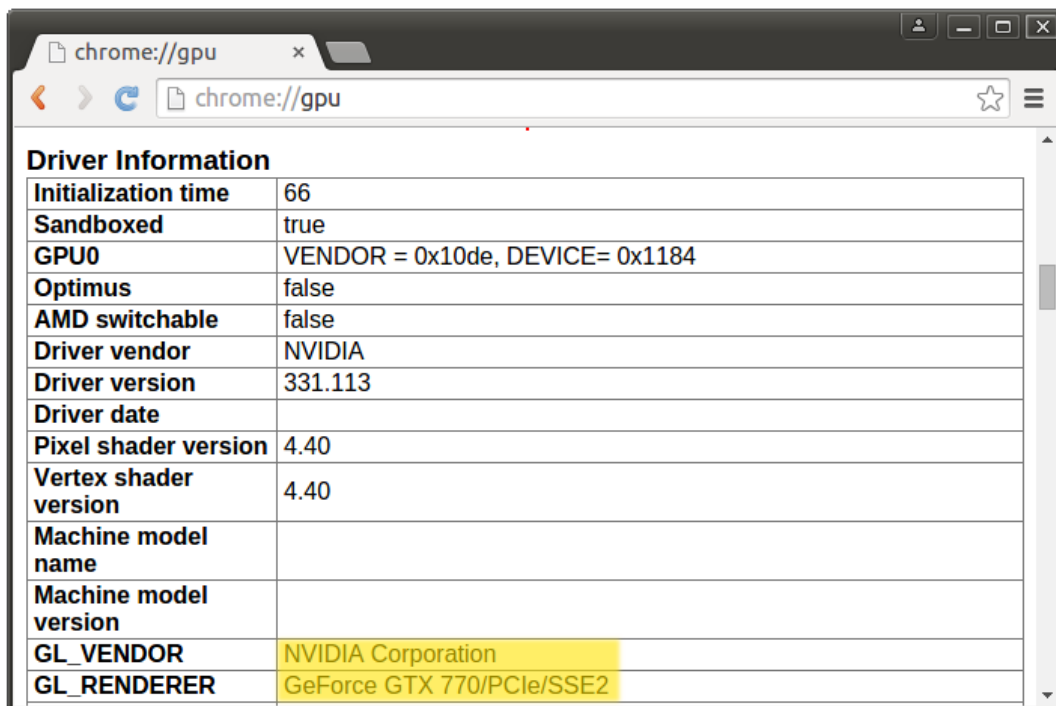

Driver Information	
Initialization time	66
Sandboxed	true
GPU0	VENDOR = 0x10de, DEVICE= 0x1184
Optimus	false
AMD switchable	false
Driver vendor	NVIDIA
Driver version	331.113
Driver date	
Pixel shader version	4.40
Vertex shader version	4.40
Machine model name	
Machine model version	
GL_VENDOR	NVIDIA Corporation
GL_RENDERER	GeForce GTX 770/PCIe/SSE2

or Firefox...

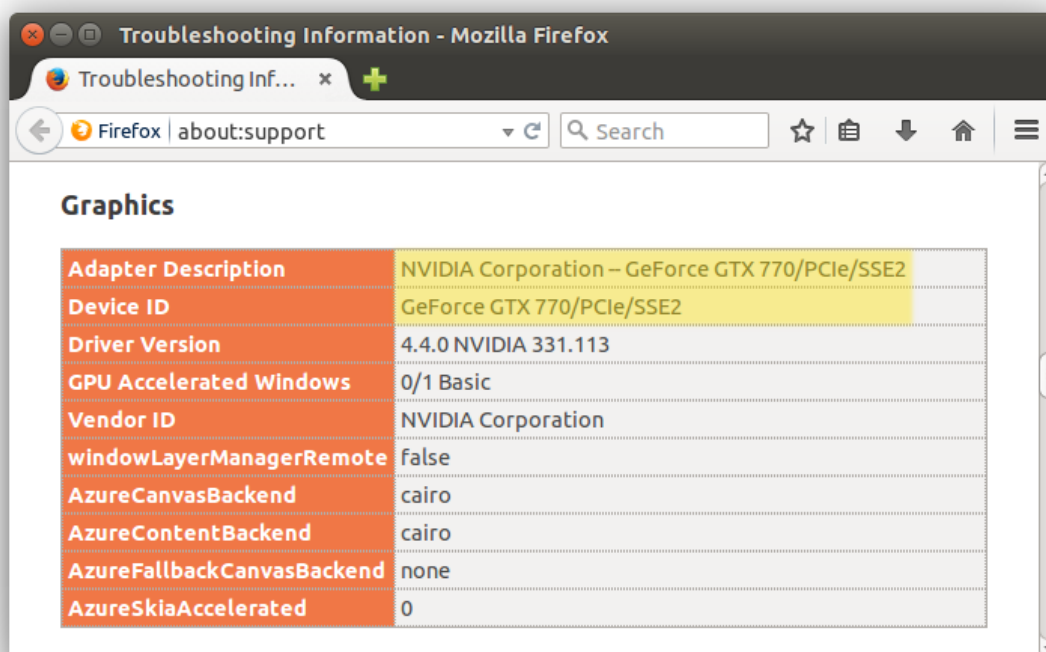

For Windows, you can run the DirectX Diagnostic Tool called dxdiag.

To do it, please follow these steps:

1. Select the Run command from the Start menu
2. Type dxdiag to the Open field and press Enter to open DirectX Diagnostic Tool
3. Open the Display panel. There you can find manufacturer, model and other information regarding your video card.

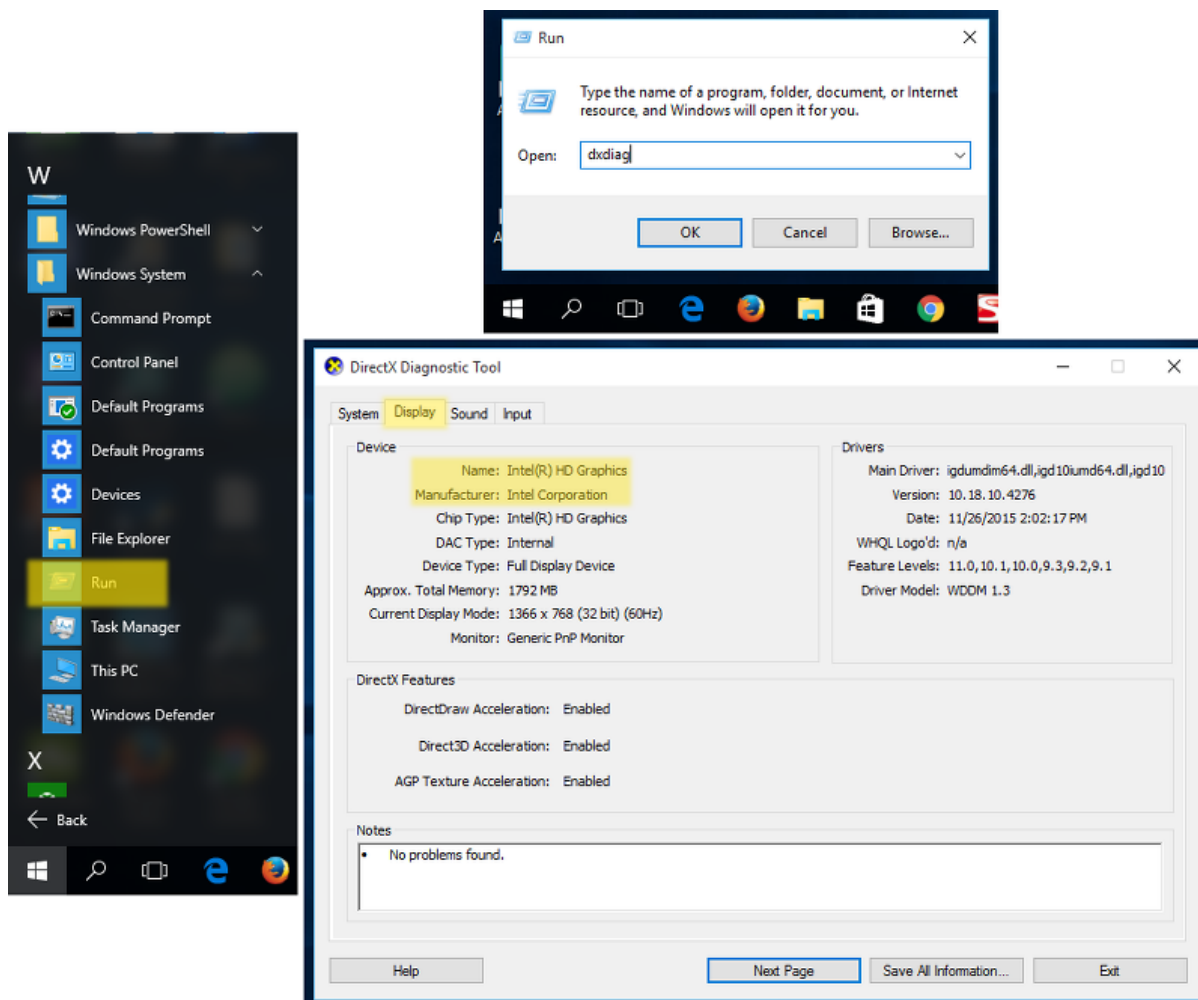

For macOS, you can check System Report.

To do it, please follow these steps:

1. Select About This Mac from the Apple menu.
2. Click System Report button.
3. Select Graphics/Displays in the Hardware section.

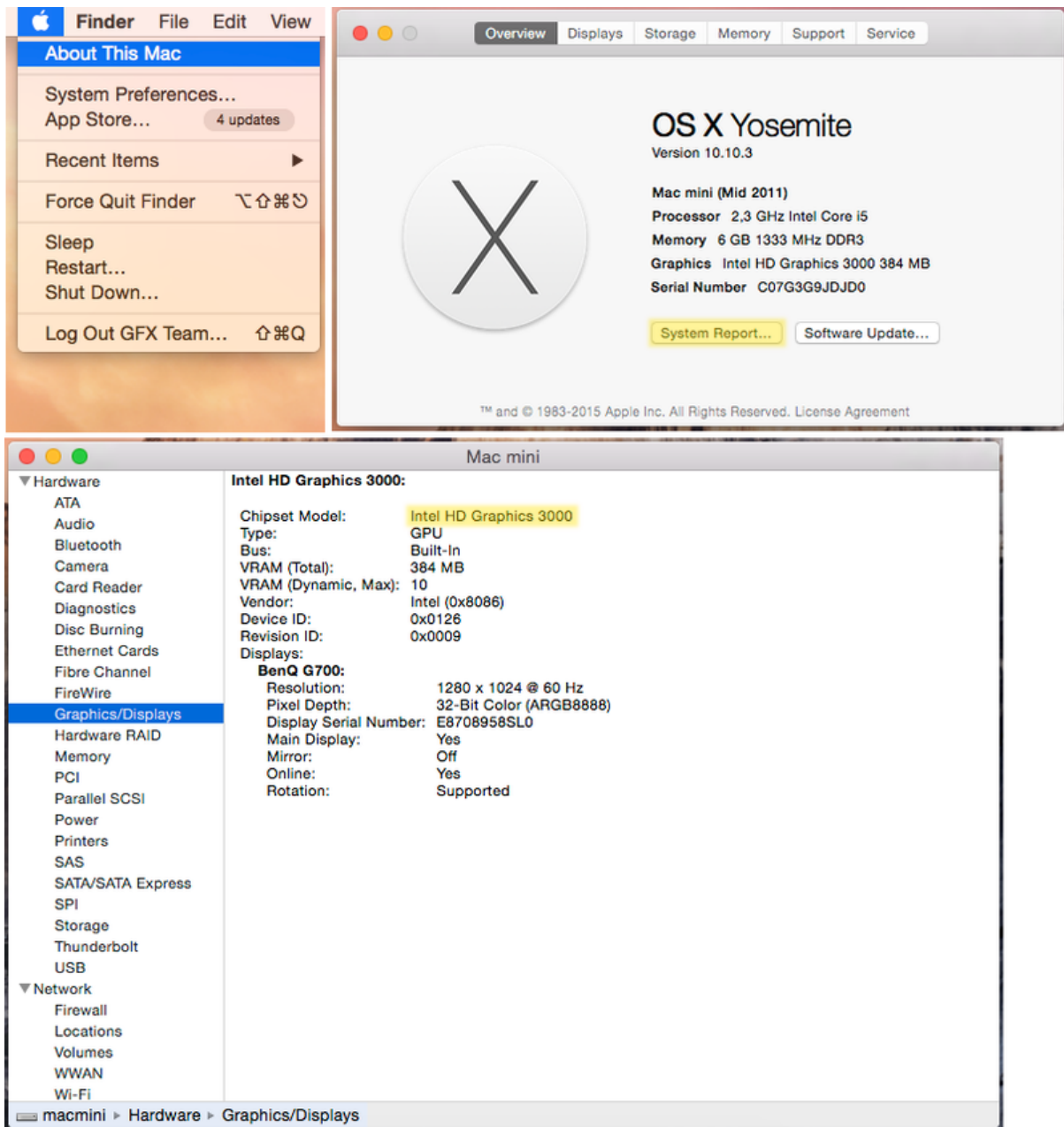

Download the drivers from the corresponding support center (for example Intel, Nvidia, AMD/ATI). Reboot the system after the drivers are installed.

3. If the measures described above did not help to initialize rendering (or there is no possibility to update the system) try to change the browser settings.

For Chrome:

Enter `about:flags` (or `chrome://flags`) into the browser's address bar, click Enable under the Override software rendering list option and restart the browser.

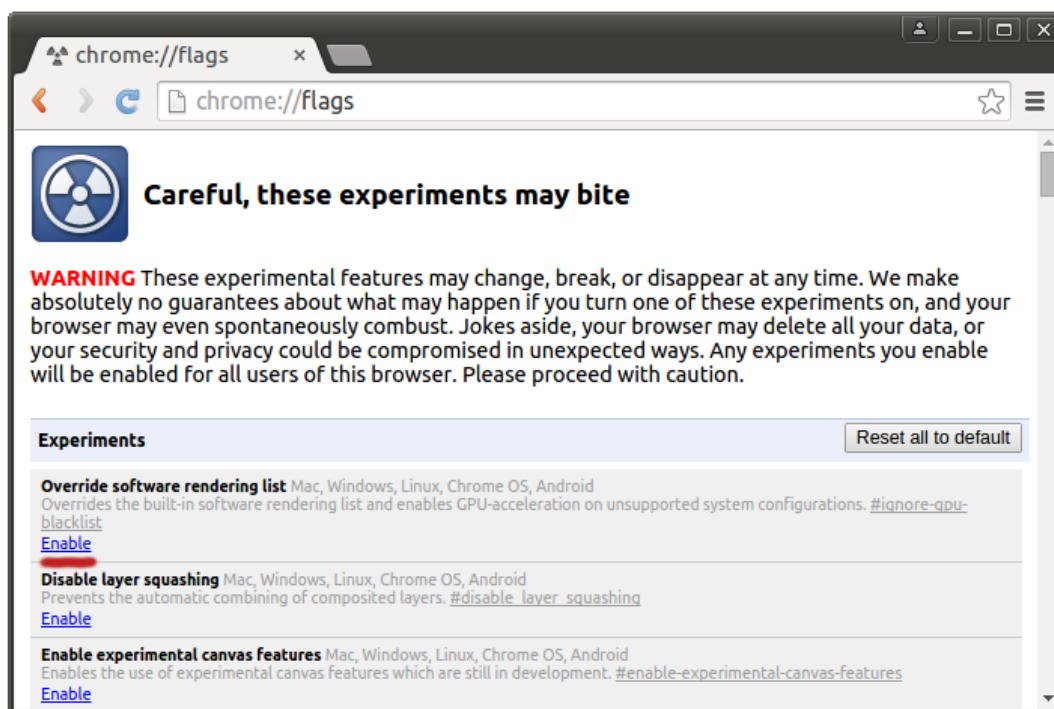

For Firefox:

Enter about:config into the browser's address bar, search for the webgl.force-enabled parameter and double-click on it to switch from false to true.

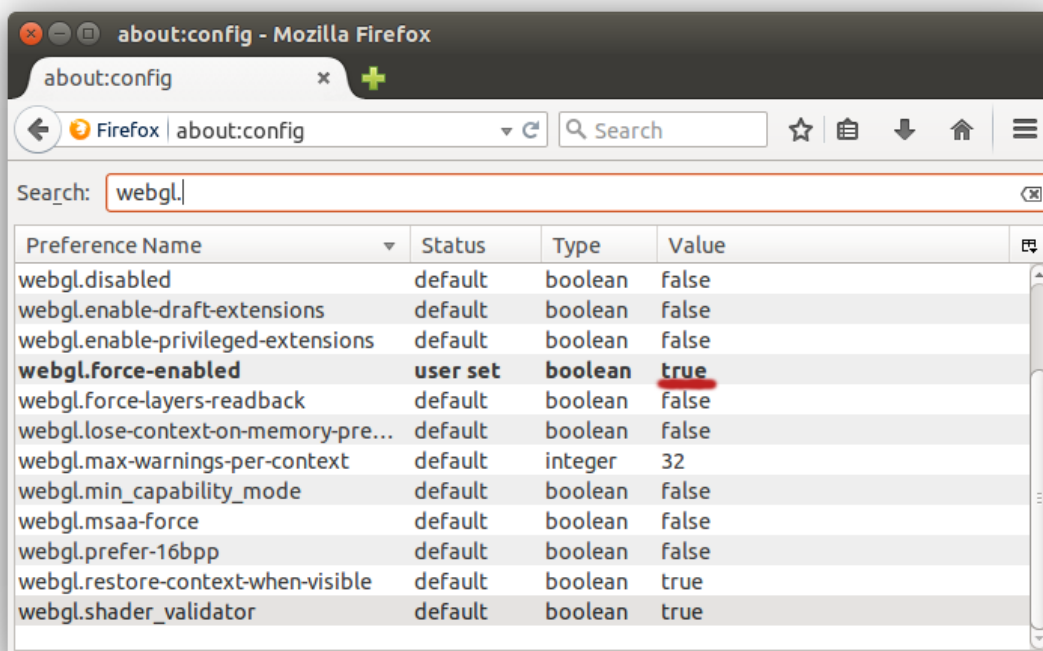

For Safari

Select Preferences from Safari menu, select the Security tab and make sure that Allow WebGL checkbox is enabled.

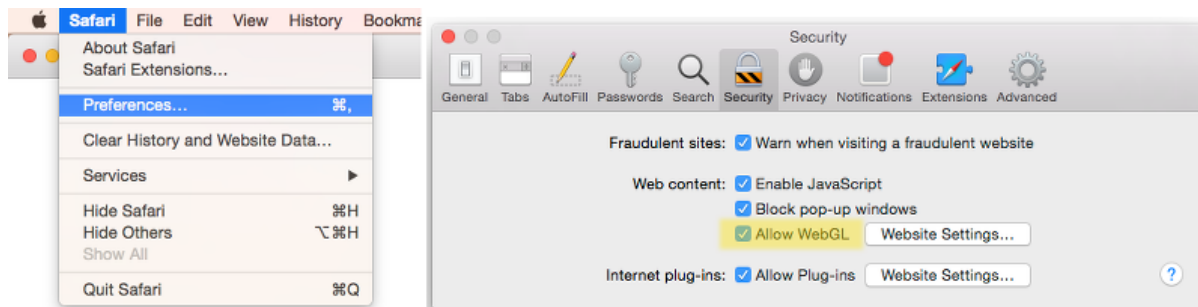

More In-Depth Troubleshooting

If nothing mentioned above helped you solve the issues you are experiencing, please visit the [Blend4Web community forum](#) and leave a message in the [Bug Report](#) thread. Our team will be sure to help you.

Known Issues

- Problems with updating of the add-on.

It's strongly advised to restart Blender after installing a newer version of Add-on/SDK.

- NVIDIA 331 driver in Linux can cause WebGL errors.
- Changed texture filtering on some platforms.

An incorrect texture filtering was disabled on iPad and Internet Explorer for materials with Alpha Clip type of transparency.

- Some devices with Mail GPU require manual WebGL activation in browser settings.
- For the local development server to work on Apple macOS and Blender 2.76, you may need to install [Python 3.4](#). This is due to a bug in Blender <https://developer.blender.org/T46623>. This bug has been fixed in Blender 2.76b, so updating it is advised.
- Skeletal animation may work incorrectly while using Nouveau drivers.
- Transparent textures may not render correctly in the IE11 and Microsoft Edge web browsers and on iPad.

The problem is relevant for the [transparent materials](#). Image artifacts are visible in the areas where alpha channel value is close or equal to zero. To fix this issue, it is recommended to increase the value of the alpha channel until artifact are no longer visible (increasing it by value from 0.01 to 0.05 should be enough in the most cases).

- WebGL crashes on Linux Chromium with Nvidia GeForce 400/500 series GPUs with drivers later than 355.

This issue is caused by incompatibility of Chromium sandbox and NVIDIA's latest drivers. The solution is to downgrade drivers to the 340xx version.

- Audio issues.

Audio doesn't work in some versions of Google Chrome for the "Background Music" speakers in case of HTML export. Currently, speaker type is automatically changed to "Background Sound" as a workaround.

There is an audio context error when running too many instances (>6) of b4w engine (for example, many browser tabs or many iframes on one page) in Google Chrome. The error is prevented by disabling the audio for an application if the audio context cannot be created for it.

Pausing the audio may not work on such mobile devices as Nexus 6 and Nexus 9 in Google Chrome 50-52 versions. It should work again in Chrome 53. More info here: <https://bugs.chromium.org/p/chromium/issues/detail?id=616772>.

- QQ Browser doesn't support WebGL at the moment.
- WebGL is unstable and sometimes crashes on Mesa 11.x drivers in Linux/Chrome with Intel GPUs. Downgrading to Mesa 10.x drivers can help.
- Information about moving fingers on GearVR touch sensor in VR-mode is not available.

Samsung Internet browser doesn't fire any events about moving fingers on touch sensor in VR-mode.

- Particles emitted by particle systems placed on inactive (hidden) layers can have their positions set to zero as inactive layers are not updated by Blender.

This problem can be solved by activating layers before exporting a scene or by simply clicking the layers to make Blender update them.

- Alpha blending objects are rendered incorrect on the Mali 400 series GPU by Google Chrome browser.
- Using several application instances in a single page can lead to excessive memory usage or even a tab crash in Chrome 59. However, this is fixed in Chrome 60.

v17.12

New Features

- Support for ES6 modules

Now Blend4Web modules can be imported using import keyword

The old modules import which use `b4w.require` also work and old applications will work without modifications

Webpack is used in build system for ES6 modules support

- Support for NPM

Blend4Web SDK now has intergated node.js. You can run it using `scripts/node.sh`

Blend4Web SDK now supports modules installed from NPM, use `scripts/npm.sh install package-name` to install the package you need

Also, you can find Blend4Web engine in NPM repository!!! `npm install blend4web`

- Fast Preview in standalone addon is now available
- New functions in physics module for controlling collision shape

`sync_bounding` - synchronize collision boundings of the mesh after shapekey change

`sync_mesh` - synchronize collision mesh after shapekey change

- Further support for Cycles materials

Basic Principled BSDF node support has been added. Supported inputs include Base Color, Metallic, Roughness, Normal. This node allows to create PBR materials accordindg to Roughness/Metallic pipeline

Transparent BSDF support has been improved and extended. This node now has custom option Use Alpha, which allows to mimic behavior of Blend4Web transparent materials with Alpha Sort blend mode

Added vertex colors support via Attribute node. The Color output of this node is similiar to the Vertex Color output of the Blender Internal Geometry node

Changes

- Now background_color parameter of the `config` affects only canvas while internal framebuffer retain default color (black).

Fixes

- Fixed camera movement in case of vertical axis is not Z-axis.
- Fixed Material/Material_ext node of the node materials, now diffuse and specular inputs are not clamped.
- Fixed the `set_nodemat_rgb`, `get_nodemat_rgb`, `set_nodemat_value` and `get_nodemat_value` methods.
- Fixed shader crash in case of using in Google Chrome.
- Fixed incorrect recursion detection in Logic Editor.
- Fixed bug in `sphinx_rtd_theme`, which caused non-working search function in documentation.
- Fixed passing and modificating global variables in Logic Editor.
- Fixed export to different drives on Windows.
- Fixed properties repetitions in Logic nodes.
- Fixed logic nodes: now maximum number of nodes is processed per frame to prevent blinking when using Show and Hide nodes.

Known Issues

The issue with SDK unpacking occurs on the Windows when using standard archiver. Workaround is to use other archiver e.g. 7zip.

v17.10

New Features

- Added side-by-side rendering stereo mode.
- Auto start tornado developer server.

Now closing one of the instances of Blender does not stop development server if there is another instance of Blender with started development server.

- Added synchronization the [Viewer](#) application and Blender.
- Changes in the physics engine.

The ability to control gravity vector in the scene has been added. Stability of the HINGE constraints has been improved. Also the `set_character_vert_move_dir_angle` method has been added to the `physics` module.

- Added new nodes to the Logic Editor: Define Function, Call Function, Switch
- Destination field has been added to the Select node. This field specifies a variable used to contains selected object after the event of selection.
- Added Object variable type to the Logic Editor.
- The UI of some nodes which use object selector is extended with ability to specify a variable
- Improved environment lighting algorithms for Cycles materials with Glossy BSDF and Diffuse BSDF nodes.

Changes

- Now NLA can be stopped with API in case of using Logic Nodes.
- Blender 2.79 is a recommended version.
- Optimized of LOD objects.
- Renamed logic nodes: Switch Select -> Select, Conditional Jump -> Branch
- We've started to use Datablock pointer properties - the new feature of Blender 2.79 in our addon. This means that you may have forward compatibility issues (see Blender 2.79 release notes)
- Simplified Logic Node Tree to the scene attachment procedure: Refresh button has been removed due to our patch for blender (D113)

Fixes

- Fixed DOF artifacts with bokeh enabled. The algorithm now requires WebGL extensions for floating-point render targets, otherwise bokeh is disabled automatically.
- Fixed HTML export of the Cycles world materials.
- Fixed false positive error producing console warning message: B4W WARN: Canvas size exceeds platform limits, downscaling.
- Fixed invisibility of the control panel in AR demo in IE 11.
- Fixed the `rotate_camera` method of the `camera_anim` module.
- Fixed the `shot` method of the `screen` module.
- Fixed some errors of API documentation.
- Fixed low FPS in the Petigor's Tale application.
- Fixed visibility of God Rays on some mobile devices.
- Fixed Mapping node with zero scale.
- Fixed the `translate_view` and `set_fov` methods of the `camera` module.
- Fixed the `get_materials_names` method of the `material` module.
- Fixed character rotation with the `set_character_rotation` and `set_character_rotation_v` methods of the `physics` module.
- Fixed missing UV and vertex colors layers after applying of the `inherit_material` method in some cases.
- Fixed loading of video textures with the ".mp4" extension.
- Fixed the `get_ortho_scale` method of the `camera` module.
- Fixed the `enable_camera_controls` method of the `app` module.
- Fixed engine crash in case of using the Value node in Emitter particles materials.
- Fixed the `set_nodemat_value`, `get_nodemat_value`, `set_nodemat_rgb` and `get_nodemat_rgb` methods of the `material` module.
- Fixed scale computation for the Curve objects with Apply Scale and Modifiers export option enabled.
- Fixed bug with NLA initialization. The bug had impact on animation start frame.
- Fixed touch sensor on slow devices.

v17.08

New Features

- Support for Leap Motion hand tracking controller.

Added the new Leap Motion code snippet. This code snippet can help you to integrate support for Leap Motion devices inside your own applications. Snippet supports two modes: realistic skinned hands and hands based on primitive objects.
- New logic node “Date & Time”.

This node allows to obtain current Local/UTC date and time (year, month, day, hour, minute and second).
- New logic node “Elapsed”.

This node returns elapsed time since last frame rendered in seconds. This node can be very useful for creating robust procedural animations.
- Improved texture cache. Added `enable_texture_cache` configuration option.

The texture cache is used for dynamically loaded scenes and can reduce scene loading time by reusing already existed textures instead of creating new ones. This option allows to turn on/off the texture cache. Enabled by default.
- Added new API methods to show/hide groups of objects.

Methods `hide_all_by_data_id` and `show_all_by_data_id` have been added to the `objects` module. They allow changing visibility of multiple objects based on their `data_id` property. Thus, they can be used to show/hide an entire dynamically loaded scene at once.

`replace_image` was added in the `textures` module. Also, `change_image` is considered deprecated.
- Optimization for procedural materials.

Implemented new packing algorithm for VALUE GLSL node. This algorithm uses a `vec4` array instead of a float array as before. This makes possible to use more VALUE nodes without a risk of exceeding GPU limits.
- A new internal module `material.js`.

This module contains internal engine logics for materials. This change requires to perform the Check Modules and Update Modules operations for old projects in the Project Manager after updating the SDK.
- Refined Logic Editor user interface.

Introduced a new Time category with Get Timeline, Delay, Date & Time and Elapsed nodes.

- Physics engine improvements.

Bullet library used by the internal physics engine upgraded from 2.82 to 2.86 release. Also, the optimized version of the engine's physics compiled with WebAssembly became enabled by default. The advantages of this are: lesser size of the physics files, faster physics initialization, improved physics stability and higher FPS.

Changes

- The version of the JSON/BIN export format was increased to 6.03.

It's recommended to reexport old .blend files for using with the latest engine version.

- Rendering of the Fresnel effect was slightly optimized.
- The option Preserve Global Rotation and Scale from the Object->Billboard panel was renamed to Preserve Global Rotation.

From now on the world scale value is always applied to a billboard object.

- Added error message in case of making recursive or self-applied constraints via the [constraints API](#).
- Added export warning in case of using multiple constraints on an object in Blender.
- Unnecessary python module 'requests' has been removed from addon.
- The user manual has been supplied with several updates:
 - A [detailed description](#) of the Blender user interface has been added
 - A [guide on using animation blending](#).
 - A [description](#) of API methods of the [constraints](#) module.

Fixes

- Minor CSS fixes in the Code Snippets application and Petigor's Tale game.
- From now on the Alpha-AntiAliasing blend mode is switched to Alpha Clip for devices with ARM Mali-T720 GPU due to rendering artifacts.
- Fixed some crashes in the Project Manager while building applications.
- Fixed a rare bug with wrong initial orientation of HOVER-type cameras.
- Disabled depth textures in Firefox under Windows for AMD GPUs to avoid some postprocessing artifacts.
- Fixed precision issues that led to some rendering artifacts on mobile devices.
- Fixed mouse wheel sensitivity, which was incorrect in some cases.

- Depth textures and also such related effects as SSAO, Dynamic Grass, Shore Smoothing, etc. were enabled for AMD GPUs in Chrome under Windows and for other GPUs in Firefox under Windows.
- Fixed frustum culling of billboard objects by properly calculating their boundings.
- Fixed rendering of the procedural fog.
- Disabled MSAA for Mali-T720 GPU because of bad performance and rendering artifacts.
- Minor fixes in the API documentation.
- Fixed bug in Safari when an object with a non-opaque node material wasn't rendered if it had the Glow Output node with the zero alpha value.
- Fixed getting mouse/touch coordinates for IE11 and Edge when an application's canvas is not aligned with the top left corner of the browser window.
- Disabled MSAA in Google Chrome 60 for macOS, because it doesn't work correctly and can lead to an engine crash.
- Minor fixes to improve stability of WebVR.
- Fixed texture caching for dynamically loaded scenes, which previously led to redundant GPU memory usage.
- Fixed applying the Array modifier to meshes with multiple UV/VC layers.
- Fixed not applying multiple material animations on one object.
- Fixed resolution of debug subscene.
- Fixed constraints caused unpredictable behavior on IE11.
- Fixed anchor visibility.
- Fixed possible memory leak. Unused debug framebuffer are removed.
- Fixed using the `hasOrientation` and `hasPosition` attributes of WebVR API. In the last WebVR Chromium build the attributes can be undefined.
- Fixed engine crash in case of using environment cubemaps with no image
- Fixed encoding issue in Project Manager for macOS.
- Fixed synchronization between the physics worker and the main thread in Chrome 61+ and removed the corresponding physics lag.
- Removed a hack for transparent node materials in Firefox under Linux, because it produced different color output among browsers.
- Fixed incorrect camera rotation via the `rotate_camera` method if the `is_abs` parameter was set to true.
- Fixed bug when the “simple” optimization level was always used for projects with the “Compile” application type regardless of their configuration options. This also fixed the optimization level for Blend4Web Player, which uses “advanced”, thus the

size of the player and player-based applications (e.g. HTML-exported scenes) was slightly reduced.

- Fixed loading of video textures on iPads in case of HTML export.

v17.06

New Features

- Support for essential Blender constraints.

Copy Location, Copy Rotation, Copy Transforms and Track To are available to use now. Also the following API methods have been added: `append_copy_loc`, `append_copy_rot` and `append_copy_trans`.

- Experimental Augmented Reality support.

Check out the AR application to get the look of the feature we're going to improve much in our next releases. The application can be found in the `apps_dev/AR` folder and is also available in Project Manager.

- New logic node Set Camera Limits.

This node allows changing limits of the camera. Each limit can be set separately. Only limits available for current move style of the camera are applied after node execution.

- Improved AA rendering.

Scheme of rendering post-processing effects has been changed. It increases performance and quality of the anti-aliasing.

- New experimental environment lighting algorithm for scenes with Cycles materials.

Materials with Glossy BSDF and Diffuse BSDF nodes automatically enable environment lighting, which takes into account roughness of the glossy component.

New algorithm requires WebGL 2.0 or WebGL 1.0 with available extension `EXT_shader_texture_lod` for correct work.

- Optimized rendering of reflections.

Cube reflections for scenes with no reflexible objects has been optimized. Now in such scenes the sky is used for reflections directly without redrawing for each individual reflective object.

- Support for camera loading.

From now on it's possible to load additional cameras to the scene using dynamic loading feature.

- Physics API improvements.

Added `set_angular_velocity`. It allows to set object's angular velocity.

Changes

- The “pivot” setting in the “params” parameter for the `target_setup` method has been made optional.
- The Material API was improved to provide more clear messages in the browser console in case of errors. Also two methods have been added: `is_node_material` and `is_water_material`.
- Sequential video fallback for video textures isn’t applied anymore in MS Edge due to the native support for `HTMLVideoElement`.

Fixes

- Fixed incorrect rendering of materials with normal mapping.
- Fixed VR code snippet.
- Fixed keyboard events when the engine is working inside an `iframe`.
- MSAA is disabled from now on for Adreno 4xx/5xx GPUs to prevent some rendering bugs.
- Fixed translating/rotating of non-active cameras.
- Fixed getting coordinates for mouse/touch events via the `get_coords_x` and `get_coords_y` methods.
- Fixed bug with looped speakers that couldn’t be stopped in Firefox after calling the `stop` and the `play` methods sequentially.
- Fixed sky redrawing after world node material parameters change.
- Removed auto applying modifiers for objects with the Array modifier.
- Fixed rendering artifacts for the transparent node materials in Firefox under Linux.
- Fixed applying a node material animation after material inheritance.
- Workers were disabled for physics simulation in IE11 and MS Edge to improve physics stability.

v17.04

New Features

- Support for world materials in Cycles.

Now, sky rendering can be set up via Cycles material nodes. Background node is used to control the resulting color of the environment. Spherical environment maps with Equirectangular and Mirror Ball projection types are also supported. World materials can be animated using Value and

RGB nodes both directly or by NLA. Use Nodes option for world objects is duplicated in the World properties panel.

- Experimental WebAssembly support for physics engine.

From now on you can use the optimized version of the Uranium.js physics engine (our JavaScript port of the Bullet engine) compiled with WebAssembly. The new `physics_use_wasm` config property is available to enable this feature. The feature is considered experimental and disabled by default.

- Experimental support for VR controllers.

Added `enable_controllers`. VR code snippet has been updated. The `create_gamepad_orientation_sensor` and `create_gamepad_position_sensor` methods have been added.

- Support for Alpha Anti-Aliasing blend mode for materials.

This is a variant of the Alpha Clipping technique which looks much better on compatible hardware. This mode requires that MSAA is enabled, hence it can work only on WebGL2-capable devices. In other cases, Alpha Clip blend mode will be used as a fallback.

- Support for loading of GZIP-compressed resources.

Instead of the standard ".json" and ".bin" files, the application can also load compressed files ".json.gz" and ".bin.gz". The same applies to DDS and PVR textures. This can be turned on in the Web Player by using the "compressed_gzip" URL parameter. To do this in a custom application, one should pass the "assets_gzip_available" flag in the `init` method. Compressed files can be generated by the Project Manager command "convert resources". However, GZIP-compressed resources should be used only if it's not possible to set up such compression on a server. More information can be found in the corresponding documentation section: [GZIP Compression](#).

- LOD system improvements.

From now on LOD level switching can be performed smoothly by using alpha test, which makes the transitions less noticeable. The corresponding option is called LOD Smooth Transitions and can be tuned in the Scene -> Object Clustering & LOD panel. Keep in mind that enabling this for all objects can significantly reduce application performance.

Also, a new option called Max LOD Hysteresis Interval has been added. Its intent is to eliminate continuous LOD switching when the camera moves near the border between 2 LOD levels. This option replaced the old LOD Transition Ratio parameter from the Object->Levels of Detail panel.

See the documentation for detailed information: [Levels Of Detail](#).

- RGBA shadows support.

It allows shadows on some devices that do not support depth texture.

- Bloom effect improvements.

New bloom algorithm has been implemented. Now it works with all lamp types and is not dependent on the direction of light. Also, adaptive average luminance calculation is available.

- Supported Non-Colour Data textures in Filmic Blender.
- Fallback for compressed textures.

When a server returns the 404 error for gzip/dds/pvr textures, the engine now tries to load non-compressed images.

- Loading stages debug flag

The `init` method now has the `debug_loading` flag which allows to track and debug loading stages through the console.

- Improvements in Normal Editor.

Factor option has been added for some operators for blending the initial and resulting states of normals.

The option to use Face operator with multiple polygons has been added.

New operator Scale has been added for scaling normal along axes.

The functionality of some operators has been improved and they have been renamed in correspondence to their new possibilities: Tree -> 3D Cursor, Foliage -> Axis.

- Added API for rendering normals of dynamic objects.

The `show_normals`, `hide_normals` methods of the `debug` module have been added.

Changes

- Removed warnings for the force fields of the None type.
- The `get_sky_params` method now returns null for non-procedural sky.
- The Use Custom Color property in the Mist panel is now disabled by default.
- The `append_object` method now works for non-copied objects as well.
- SSAO Influence upper limit has been increased to 2.0.
- Canvas is no longer resized to 320x240 if one or both of its sizes have zero dimensions.
- Dimensions of the cube sky render target are adjusted dynamically after an environment texture image is changed.

Fixes

- Improved Russian translation for addon entries in the Help menu.
- Fixed some inaccuracies in the API documentation.
- Fixed Do Not Export option for objects used as LOD levels. Previously, it didn't work.
- Fixed problem with FPS decreasing in the Viewer app after selecting an object.
- Fixed LOD switching for dynamic objects, when more than one LOD level was rendered at the same time.
- Identical packed images/sounds are unpacked during export into a single file instead of multiple identical files.
- Fixed Normal Map node strength clamping. Values less than 0 now have no influence on the normal.
- Unnecessary fog updates for world animation were removed.
- Empty objects with dynamic materials no longer crash the engine.
- Fixed texture cloning bug which caused memory leaks.
- Fixed batch sorting by `alpha_clip` param.
- Fixed Foam + ShoreMap texture crash in water material.
- Fixed space conversion in Normal Editor.
- Fixed Project Manager server behavior for nonstandard python environment.
- Fixed incorrect rendering of materials that use normal mapping.
- Fixed texture filtering for right eye in VR mode.
- Fixed crashes on IE11 in case of using `client_to_element_coords`.
- Fixed `is_hideable`, `show_object`, `hide_object` methods.
- Fixed crash for Cycles materials with non-connected Surface outputs.

v17.02

New Features

- Project Manager improvements.

To simplify project configuration a new visual configurator has been implemented. To configure your project just click on the [config] link near the project name on the Project Manager's main page. Project configurator works in a non-destructive way and allows you to change only editable params for the current project.

The clone project functionality was added.

JavaScript source maps were added. Source maps allow developer tools located in browsers to display unminified code from minified code with optimized “mapping” between them. To generate source maps specify `-b` flag to `project.py` script when building your project.

- User interface improvements.

To make the task of creating Blend4Web content more efficient we refined the Blender UI.

Render and Help menus have been modified for Blend4Web render engine.

Messages about unsupported editors have been added.

‘Rigid Body’ panel has been removed from View3d tools for Blend4Web render engine.

Blend4Web credits have been added to the splash screen.

- Further support for materials powered by Cycles.

Support for Displacement output has been added. This output is used to easily add bump to material.

Transparent BSDF node support has been added. This node is from the Shader category. It is used to add transparency without refraction, passing straight through the surface, as if there were no geometry there.

- Extended material inheritance.

The `inherit_material` method was greatly improved to support node materials. It requires the source and the target objects to have the Dynamic Geometry & Materials option (which previously was named Dynamic Geometry) enabled on the Object panel. This option also means that all UV and vertex color layers are exported to be available to use in any material that is applied to the target object. More information about using this functionality can be found in the [corresponding chapter](#) in the documentation.

- “Code Snippets” improvements.

The “Make project” button has been added. It is now possible to create new projects based on code snippets. It provides the possibility to use ready-made templates for further development.

- Camera improvements.

Support for Horizontal and Auto camera fits has been added.

- Wind Bending setup API.

Wind Bending parameters can now be set with `set_wind_bending_params`, and they can be extracted with `get_wind_bending_params`. Note that this API works only with

dynamic objects. A special menu for Wind Bending was added to the Viewer interface.

- Shadow Blur and reflection quality configuration

New parameters: `shadow_blur_samples` and `reflection_quality` have been added to the `config` module. They can be assigned with the `set` method.

- Support for Blend4Web addon customizations.

To simplify Blend4Web addon customizations a new field `b4w_custom_prop` can be added to Object or Scene datablocks. This option can be exported to Blend4Web format and accessed in runtime by `scenes.get_custom_prop` or `objects.get_custom_prop` methods. An example on how to use this feature can be found in `addons/blend4web/custom_prop_example.py` file in the SDK.

- Changes in the process of exporting UV layers.

The restriction of 2 UV layers per mesh has been removed. Also, if a UV layer is not specified then the active layer is used instead of the first layer in the list as it was previously. Unused UV layers will not be exported unless the object property Dynamic Geometry & Materials is enabled.

Changes

- Project Manager changes.

“External” engine type was deprecated and replaced by “Copy” type automatically.

- Empty material slots are now correctly exported and do not stop export process.
- Blender addon now resides in an independent addon category named Blend4Web.
- Incompatible textures and constraints now print warnings in Blender UI.
- Skeletal animation blending now works correctly for two animations. This feature is still experimental and API is subject to change.
- Static physical objects now correctly influence a scene when dynamically loaded or unloaded.
- `fps` addon received several improvements. The `enable_fps_controls` method now has several setup parameters. Refer to API documents for more details.
- API changes.

The `set_canvas_offsets`, `update_canvas_offsets`, `force_offsets_updating` methods of the `container` module have been declared deprecated and will be removed in future releases. Use the `client_to_canvas_coords` or the `client_to_element_coords` methods.

The `screen` module has been added.

The `request_fullscreen_hmd`, `enable_split_screen`, `disable_split_screen`, `request_fullscreen`, `exit_fullscreen`, `check_fullscreen` methods have been declared deprecated. Use `request_fullscreen_hmd`, `request_split_screen`, `exit_split_screen`, `request_fullscreen`, `exit_fullscreen`, `check_fullscreen` instead.

The `draw_mixer_strip`, `plot_array`, `shot` methods have been declared deprecated and moved to the `screen` module. The `hud`, `screenshooter` modules have been declared deprecated.

The `set_hmd_fov` method has been declared deprecated.

The `util.ground_project_quat` method has been renamed `ground_project_cam_quat`.

The following deprecated methods have been removed:

<code>camera.set_move_style</code> ,	<code>camera.has_vertical_limits</code> ,	<code>camera.has_horizontal_limits</code> ,	<code>camera.move_pivot</code> ,	<code>camera.set_velocity_params</code> ,	<code>camera.get_velocity_params</code> ,	<code>camera.clear_horizontal_limits</code> ,	<code>camera.clear_vertical_limits</code> ,	<code>camera.clear_hover_angle_limits</code> ,	<code>camera.set_look_at</code> ,	<code>camera.rotate_eye_camera</code> ,	<code>camera.rotate_target_camera</code> ,
<code>camera.set_trans_pivot</code> ,	<code>camera.zoom_object</code> ,	<code>camera.set_pivot</code> ,	<code>camera.rotate_hover_camera</code> ,	<code>camera.get_hover_cam_pivot</code> ,	<code>camera.get_eye</code> ,	<code>camera.get_pivot</code> ,	<code>camera.hover_cam_set_translation</code> ,	<code>camera.set_hover_pivot</code> ,	<code>camera.get_hover_angle_limits</code> ,	<code>camera.get_cam_dist_limits</code> ,	<code>camera.apply_vertical_limits</code> ,
<code>camera.apply_hover_angle_limits</code> ,	<code>camera.apply_distance_limits</code> ,	<code>camera.clear_distance_limits</code> ,	<code>camera.get_vertical_limits</code> ,	<code>camera.apply_horizontal_limits</code> ,	<code>camera.get_horizontal_limits</code> ,	<code>controls.register_keyboard_events</code> ,	<code>controls.register_mouse_events</code> ,	<code>controls.register_wheel_events</code> ,	<code>controls.register_touch_events</code> ,	<code>controls.register_device_orientation</code> ,	<code>controls.unregister_keyboard_events</code> ,
<code>controls.unregister_mouse_events</code> ,	<code>controls.unregister_wheel_events</code> ,	<code>controls.unregister_touch_events</code> ,	<code>controls.unregister_device_orientation</code> ,	<code>app.resize_to_container</code> ,	<code>app.set_camera_move_style</code> ,	<code>app.enable_controls</code> ,	<code>app.disable_controls</code> ,	<code>hmd.get_hmd_device</code> ,	<code>hmd.reset</code> ,	<code>animation.get_first_armature_object</code> ,	<code>animation.get_bone_translation</code> ,
<code>constraints.get_parent</code> ,	<code>util.line_plane_intersect</code> ,	<code>util.is_mesh</code> ,	<code>util.is_armature</code> ,	<code>tsr.create_sep</code> ,	<code>sfx.is_play</code> ,	<code>scenes.check_object</code> ,	<code>scenes.get_object_dg_parent</code> ,	<code>nla.check_nla_scripts</code> ,	<code>main.resize</code> ,	<code>main.global_timeline</code> ,	<code>main.get_canvas_elem</code> .

The `add_click_listener`, `remove_click_listener` methods have been added.

- VR mode changes.

Switching to VR mode can now be done without reloading the application in VR-capable browsers: WebVR-supporting browsers or mobile

browsers.

Camera autorotation is disabled when switching to VR mode.

Added support for WebVR 1.1.

- The `is_character` method no longer returns true if physics is disabled in an application.
- The paragraph [Non-Standard Canvas Position and Orientation](#) was rewritten to reflect recent engine changes.

Also, the new paragraph [Mobile Web Apps](#) was added to describe some aspects related to the orientation and the scaling of a browser's page.

- The [Material API](#) paragraph has been added to the user manual. It describes how object materials can be adjusted using API methods from the `material` module.
- The structure of the `SSAOParams` object used in the `set_ssao_params` and the `get_ssao_params` methods was changed to be more consistent.
- The `object_distance` method has been declared deprecated, from now on the `distance` method should be used instead.
- The `create_ray_sensor` and the `new_event_track` methods no longer accept a non-physical object as a parameter, which led to engine crash.
- Video textures can no longer be changed via the `change_image` method.

Fixes

- Fixed bug when anchor description contains not only text nodes.
- Fixed crash for non-valid materials used by Emitter particle systems.
- Fixed some errors for same-titled linked objects and groups.
- Removed the duplicated Simplify panel created by Blend4Web in other Render Engines.
- Fixed texture caching with incompatible texture sources.
- Fixed emitter particle normals.
- Fixed Rendering to texture broken in the previous release.
- Several fixes for the `prefetch` method.
- Fixed SRGB color correction in Ultra mode.
- Fixed FPS reducing in iOS browsers.
- Fixed binary loading in case tmp directory doesn't allow execution. This issue was fixed by using standard Blender tmp path, which can be configured.
- More correct extending of node editor Add menu.
- `assets.json` has been removed from all blend files.

- Fixed the reloading of binary module when pressing F8.
- Fixed HMD configurator.
- Fixed bug when the visibility of scene layers in Blender can be changed after export.
- Fixed wrong behavior of video textures in Firefox.
- Fixed shadows and reflections for dynamic grass.
- Fixed shader compilation crash if the LOW quality profile was chosen.
- Fixed object selection and shadows for objects with a node material, which had the Alpha Clip blend mode.
- Fixed the checking of unsupported texture sizes.
- Fixed the overriding bounding volumes functionality for objects with shape keys.
- Fixed the selection and the outlining of LOD objects.
- Fixed engine crash when an object had the Array Modifier applied in Blender.
- Fixed bugs related to the `set_ssao_params` method.
- The Google Closure Compiler used for compiling the engine's scripts and applications was updated to the newest version. This helped to find and fix several minor bugs.
- Fixed engine crash when applying a shape key to an object with HAIR or EMITTER particle systems.
- Fixed the "Hidden" property for EMPTY objects used as anchors.

v16.12

New Features

- Project Manager improvements.

New File and Save As buttons were added to the project file editor. Also, to simplify navigation, the editor highlights edited files.

Project Manager application builder now minifies compiled HTML files to speed-up their loading.
- New Cycles material nodes.

Emission node support has been added. This node is from the Shader category. It is responsible for the light emitting component of the material. Node inputs include Color, Strength. In Blend4Web, materials which use this node only simulate the look of the surface and are not dynamic light sources.
- Improved rendering of LOD objects.

From now on LOD objects are batched with respect to their LOD distance parameter and their proportions. Thus, the engine renders LOD objects as effectively as possible, trying to keep a reasonable amount of the combined objects at the same time. For tuning this behavior the LOD Cluster Size Multiplier parameter was added into the Scene->Objects Clustering panel.

- New API methods `prefetch` and `unfetch`.

The first allows preloading resources of a scene (textures, sounds, files of the scene) and caches them. The second allows cleaning up the cache.

- Support for object picking on VR devices.

The `pick_center` method has been added. It allows users to get an object in the center of the viewport using the object picking functionality. This method works both for general-purpose and for VR devices.

- Improved add-on interface.

Now the stand-alone add-on does not show the development server panel. Extended warnings, that the development server is not available on the standalone add-on, have been added.

- Texture caching

Now all image textures are cached and if a new texture with similar properties is requested, it will be taken from the cache. This results in saving memory and significantly speeds up the `change_image` method for multiple objects.

Changes

- Project Manager changes.

The structure of Project Manager files was upgraded. Now new projects are placed in the projects directory. All assets are placed in the project folder.

Please note that `get_std_assets_path()` no longer specifies project assets directory within the new file structure. Replace it with the `get_assets_path()` method.

The upgrade file structure button was added to [upgrade the old projects to the new structure](#).

Now text inside the project manager editor is indented with spaces instead of tabs.

- Lamp objects of the unsupported AREA type are changed to the type SUN during the export from now on. In this case, a related error message will be printed in the browser console.

Fixes

- Fixed a bug with video textures on mobile Chrome.
- Fixed a bug with Alpha Sort type of transparency for static objects.
- Fixed a bug with incorrect rendering of materials that use normal mapping.
- Fixed a bug when the LODs of a single object were switched between each other with a very noticeable delay and none of the LODs were rendered at that very moment.
- Fixed a bug with dynamic grass on WebGL 2.0.
- Fixed a bug with Wacom tablet interaction.
- Fixed “Export to different disk is forbidden” message that was showing up when using fast preview.
- Fixed crash during the export of dupli groups without any attached objects
- Alpha values greater than 1.0 are now correctly processed for transparent materials.
- PARALLAX node no longer crashes node trees if its input texture has any output nodes apart from the PARALLAX node itself.
- Shader node trees are now pre-cleaned during export to get rid of unused nodes.
- Fixed viewport alignment in VR mode.

v16.11

New Features

- Added partial support for materials powered by Cycles render nodes. List of currently supported Cycles nodes:

Material Output node is similar to Output from Blender Internal except it utilizes a shader type input socket. Surface node input is the only one currently supported. This node defines material as a physically based rendered (PBR) material.

BSDF Diffuse node is from the Shader category. It is responsible for the diffuse component of the material lighting and produces no visible reflections. Node inputs include Color, Roughness, Normal. This node has single shader type output socket.

BSDF Glossy node is from the Shader category. It is responsible for the specular component of the material lighting and reflections of the environment. Node inputs include Color, Roughness, Normal. This node has single shader type output socket. The only currently supported specular distribution is GGX. This node automatically enables real-time cube

reflections for the object, which uses the material and is not set as reflective. Reflexible environment and objects should be configured according to standard b4w pipeline. Roughness currently does not affect reflections.

Mix Shader node is from the Shader category. This node is used to mix outputs of nodes from the Shader category. Node inputs include Fac, which defines mixing ratio, and two Shader inputs. This node has single shader type output socket.

Fresnel node is from the Input category. This node computes how much light is reflected off a material layer, where the rest will be refracted through the layer. The resulting weight can be used for layering shaders with the Mix Shader node. It is dependent on the angle between the surface normal and the viewing direction. Node inputs include IOR (index of refraction) and Normal. This node has single scalar type output socket.

Layer Weight node is from the Input category. This node defines a weight typically used for layering shaders with the Mix Shader node. Node inputs include Blend and Normal. Node inputs include Fresnel and Facing.

Other supported nodes include Image Texture, Environment Texture, Object Info, Bump.

Other partially supported nodes include Texture Coordinate (From Dupli parameter is not supported), UV Map (From Dupli parameter is not supported), Geometry (Pointness and Parametric outputs are not supported).

Nodes supported in previous b4w releases, which are used in both Cycles and Blender Internal, will also work fine with new PBR materials. Such nodes include Color Ramp, Normal Map, Camera Data, Particle Info, RGB, Value, nodes from the Converter category (except Blackbody and Wavelength nodes), nodes from the Vector category, nodes from the Color category (except Light Falloff node).

- Project Manager improvements.

The project file editor was added. Now CSS, JavaScript, HTML and .b4w_project files can be edited in the Project Manager.

- New first-person (fps) add-on was added.

The add-on helps to create first person applications easier. There are two main methods in it: `enable_fps_controls` and `disable_fps_controls`. The first creates default gamepad and keyboard controls, enables mouse and touch camera movement, enables VR camera rotation if VR mode is enabled. The second disables these controls. There are also other methods in the new add-on: `bind_action`, `set_character_state_changing_cb`, `set_cam_smooth_factor`, `set_cam_sensitivity`, `set_plock_enable_cb`, `set_plock_disable_cb`.

- Improvements with 3D Navigation Mesh.

Now the `navmesh_find_path` method of the `physics` module finds 3d

path, it allows us to construct paths on vertical surfaces. Previously, one was only able to construct path on horizontal planes. The parameters of the `navmesh_find_path` method has been changed. Initialization time of navigation mesh has been reduced. A* algorithm has been improved.

- Blend4Web addon usability improvements.

Blend4Web SDK Directory field in addon properties has been removed. Now, path to Blend4Web SDK directory resolved automatically.

Changes

- API changes.

The parameters of the `shot` method and the `canvas_data_url` method have been changed.

A new function `get_camera_angles_dir` has been added into the `camera` module. It allows to get a camera's spherical coordinates from the given direction representing the view vector of a camera.

- Simplified Environment Setup.

Water now uses the default wind when the wind object is absent in a scene. A water object is now always dynamic. Procedural sky uses the default sun direction when a sun object is absent in a scene.

- NPC AI now caches all animation on initialization.

This slightly increases the loading time but removes real-time delays caused by npc animation.

- The Fast Preview button is now available in the Cycles render profile.
- The `get_all_objects`, `get_object_by_name` and `check_object_by_name` methods no longer return the engine's internal meta-objects, which are not intended to use in an application.

Fixes

- Project Manager compatibility with the old build type update was added.
- Fixed bug with specific encoding in the Project Manager.
- Fixed bug with the same module names conflicting in the Project Manager.
- Specular shading bug was fixed.

The bug, which happened when two or more lamps were used for material with the Blinn specular type, was fixed.

- NLA unloading bug was fixed.

Now all objects belonging to the unloaded scene are removed from NLA.

- Stereo blinking bug was fixed.

The bug appeared when using motion blur effect.

- Overwriting resources with the same names in temporary directory when using Fast Preview was fixed.
- Fixed Network error while downloading a screenshot.
- Fixed shader crash occurring in some scenes in LOW quality mode.
- Fixed engine crash for scenes without MESH objects.
- Fixed the `track_to_target` method, which previously performed incorrect zoom animation.
- Fixed a rare bug related to empty particle texture slots, which could lead to export crash.
- Fixed rendering of the procedural lines.
- Fixed Play Animation logic node bug when animation stopped playing after the first time.
- Fixed crash in navmesh module in web-browsers without support of `indexOf` method for `TypedArray`.
- Fixed silent failure in Project Manager during resource converting in case of `ffprobe` missing.

v16.10

New Features

- Added support for navigation meshes.

Two methods were added to physics module: `navmesh_get_island` for getting closest navmesh segment and `navmesh_find_path` for path finding.

Two types of paths are available: one path based on centers of triangles, and a more optimal - pulled string.

See example in the Code Snippets apps.

- New logic node Set Camera Move Style.

This node allows changing move styles and velocities of the camera. Target parameters for Target and Hover camera types can be set as separate coordinates or as a target object.

- Tangent shading support for edited normals.

Tangent shading is now supported for edited normals.

- Improved Project Manager usability.

Now applications, blend files and project assets open in new browser tabs. Having your Project Manager remain in the same window makes work more efficient.

compile project command was renamed as build project. This new name is more suited to the nature of this command.

- New environment texture blend types.

Now all texture blend types are supported for environment lighting.

- Sphere flag is now supported for Point and Spot lights.

This flag allows specifying a distance at which the light's intensity drops to zero.

- Rotated boundings.

Now rotated bounding boxes are used for frustum culling calculations. Also, rotated bounding ellipsoid is now supported for dynamic objects.

- JS Callback logic node can now be called synchronously.

Return true from your callback for freezing nodetree execution in this node and false when the node has finished its execution.

- New API methods `get_fog_params` and `set_fog_params`.

These methods allow controlling mist in a scene. Fog params contain `fog_intensity`, `fog_depth`, `fog_start` and `fog_height` properties.

- New API method `update`.

This method allows to update anchors positions.

- Added support for VBO buffers of different types.

Some attributes were changed to be of the type UNSIGNED BYTE and SHORT instead of FLOAT without loss in quality that reduced total GPU memory cost. This also affects performance and can increase frame rate in some demos. Along with that the size of exported .bin files was slightly decreased by changing the export type of vertex colors from SHORT to UNSIGNED BYTE.

- In ULTRA mode the correct SRGB-conversion function is now used instead of a simplified one.

The effect is mostly notable in dark areas where the simplified function doesn't yield precise colors.

- Added special buttons for enabling/disabling the World Background option in 3D VIEW panels.

These buttons are disposed in the World tab and should be used if the Render Sky option is set. Enabling the World Background shows world colors in the viewport (the same as in the engine).

Changes

- Refactored projects inside the SDKs.

Now all projects (including tutorials) inside the SDKs follow the standard Project Manager directory hierarchy.
- Removed scenes list from the Viewer app.

The same functionality (browsing and viewing project assets) can be carried out using the Project Manager.
- API documentation of the `input` module has been expanded, examples of using functions have been added.
- The number of `batches` was decreased which optimizes scene rendering.

This optimization mostly affects shadows and hair particles. It enhances frame rate in scenes that use this functionality.
- Now keyboard device is attached to document object by default.
- Added None as a new Engine Binding Type.

This means the Project Manager will not change your projects during the build phase.
- Removed the Update Engine Binding Type.

Use the Copy Engine Binding Type and the Project Manager's deployment feature to reproduce the same behavior.
- Added light versions of the SDK builds.

Now Blend4Web PRO and Blend4Web CE SDKs have lighter versions available, which do not include demo applications and tutorials. These versions are recommended for users with a slow internet connection.
- Depth textures was enabled for the Intel HD Graphics 3000 which allows the use of such effects as shadows, god rays, depth of field and others on this device.
- Now NLA animation takes frame start/end values from vertex animation itself.

This allows having multiple vertex animations controlled by NLA for one object.
- Some mobile devices (including IOS) now do not force low quality nodes in materials.
- API documentation for `BloomParams` has been added. Some parameters have been renamed.
- Changed payload of `mouse_click`, `mouse_move`, `touch_click` and `touch_move` sensors. Now it's a dictionary, containing absolute coordinates (`coords`) for all mentioned above; which for `mouse_click`; `gesture` for `touch_move`.
- `default_AND_logic_fun` and `default_AND_logic_fun` logic functions are now available in controls module.

- Removed deprecated scripts for binary module cross-compilation.
- API methods `set_nodemat_value`, `get_nodemat_value`, `set_nodemat_rgb` and `get_nodemat_rgb` are now deprecated and moved to the `material` module.

Fixes

- Fixed the `quat_to_euler` function.
- Fixed incorrect behavior of the Normal Map node with non-unit strength parameter.
- Fixed some runtime checks for objects in logic nodes.
- Fixed the inability to change a texture on one object (the `change_image` function) when it is shared between multiple materials.
- CookTorr specular model now looks similar to the one in Blender.
- Alpha Sort materials now behave correctly for non-deep copies of objects.
- Fixed the `create_pline_from_point_vec` and `set_pline_initial_point` methods.
- Walking characters with a behavior based on the `npc_ai` module now do not fall underground.
- Fixed bug when two or more anchors of type Custom Element can reference the same element id.
- Fixed reflections for spherical billboards.
- Fixed audio resuming after pausing for the Background Sound and the Positional Sound speakers in Firefox.

v16.09

New Features

- Web Player improvements.

An option to set up social network buttons located in the bottom-right corner of a loaded scene. To do this, you need to specify the `socials` attribute before the application starts.
- Coordinate System change.

Now Blender's coordinate space is used instead of OpenGL's. This new behavior can introduce various incompatibilities in application logic. Developers are advised to review their apps and make changes according to the new coordinate space (*Z* vector up).
- Optimized geometry rendering.

Geometry rendering has been optimized by implementing a new algorithm for storing data in GPU memory. Now normal and tangent data has been stored in TBN quaternions.

- Project Manager improvements.

Added the new `update_modules` command to the `project.py` utility. This command allows users to update engine's modules inside developed applications. This feature significantly simplifies updating project files to newer Blend4Web versions.

- Automatic quality detection.

By specifying the `AUTO (P_AUTO)` quality profile in the `app` module you can load your app in `LOW` or `HIGH` quality depending on your hardware specs. Also, a low-level performance benchmark can be executed using the `test_performance` method.

- PVRTC conversion support.

PVRTC conversion is now supported. This allows developers to use compressed textures on iOS and PowerVR-based Android devices.

- Shadow quality settings added.

Now it is possible to set different quality profiles for soft shadows: `16x`, `8x`, `4x`.

- Shading panel was added to the Render tab. It contains World Space Shading option and Set Recommended Options button to auto configure Blender for better Blend4Web experience.

- Added support for Blender 2.78.

World Space Shading option paired with the support for environment lighting for the GLSL mode in viewport makes rendered b4w scene maximally match it's viewport preview.

New shader node Normal Map is fully supported.

Changes

- The system for assigning shader directives was refactored. This feature reduces engine loading time and simplify debugging.
- Rendering the anchors was speeded up on some devices by using the “`translate3d`” CSS property.
- Shader validation has been improved, which decreases amount of false negative errors. More error descriptions have been added.
- Major part of shader computations was moved from matrices to TSR to increase performance.
- The Render tab panels' order was rearranged.

Fixes

- Fixed the bug in the Samsung Internet browser when it hung if there were many anchors in a scene.
- Fixed Web Player “alpha” attribute, which didn’t work.
- Fixed compilation/linking shader error message.
- Fixed rotation at angle defined by variable value in the Transform Object logic node.
- Fixed behavior of the Play Animation logic node in case of baked and non-baked versions of the action co-exist.
- Fixed quality settings for plane reflections.
- Fixed `get_translation_rel` and `get_rotation_rel` methods.
- Fixed `dof_distance` setting with `set_dof_params` method.
- Fixed the bug when an object with both Do Not Render and Enable Outlining options enabled led to the engine crash after it was selected.
- Fixed physics for particle system.

v16.08

New Features

- Materials Tangent Shading option is now supported.

This option can be used to imitate anisotropic material surfaces, such as polished metals, hair, etc.

- Shader node Normal Map is now supported.

This node allows converting color data from texture to a normal map. The input data can be in tangent, object or world coordinate space. The Strength parameter controls the mixing values extracted from the texture with an object’s default normals.

The color space of a texture image should be set to Non-Color to make Blender’s viewport preview match the final Blend4Web scene.

- Engine CPU optimizations.

Several CPU and GC (Garbage Collector) optimizations have been made in the engine’s core systems. `OES_vertex_array_object` extension was supported on appropriate hardware. Uniform and shader usage was also optimized reducing the total amount of WebGL calls. This should improve scene load time and rendering responsiveness, especially for slow CPUs.

- Interface improvements in the Viewer app.

The Tools & Debug panel has been moved and is now located directly under the Scenes panel.

The Min capabilities mode button has been added to the Tools & Debug panel. This parameter makes the Viewer app run the loaded scene as if it was running on a low-end system (such as iOS devices). This allows an artist to find out which materials in the scene may not work as intended on a low-end configuration.

- Normal editor improvements.

Added Offset mode for normal editing.

Added Average operation support for non-split normals.

Added the possibility to type the angle of normal rotation just like inputting an object's rotation.

- New API method in the `textures` module.

The `get_texture_names` method has been added. It allows us to get all object texture names.

- New API methods in the `lights` module.

The `get_light_color`, `set_light_color`, `get_light_energy` and `set_light_energy` methods have been added. These are used to work with the color and energy values of a lamp.

- Support for Hidden object property.

This flag hides objects upon scene loading.

- Support for GLSL ES 3.0 shaders.

From now the engine automatically chooses which version of the OpenGL Shading Language should be used to compile/link shaders. It depends on the WebGL context: GLSL ES 1.0 version is used for WebGL 1, and GLSL ES 3.0 - for WebGL 2. The engine's shader system and macro pre-processor was also changed to be compatible with both of these variants.

This feature lifts restrictions on implementing new functionality related to WebGL 2 without compatibility issues.

- Improvements in Shader Analyzer.

Shader Analyzer (method `analyze_shaders`) now prints low-level assembly code which helps in reviewing and optimizing shaders.

Changes

- Depth-of-field (DOF) bokeh effect algorithm improvements.

Intensity leakage (or pixel bleeding) artifact, when foreground objects in focus appear to ‘leak’ onto blurry backgrounds, has been reduced.

The Foreground Blur property has been added. When enabled, it reduces the appearance of sharp silhouettes on unfocused foreground objects against focused backgrounds.

Front Start, Front End properties for foreground and Rear Start, Rear End for background allows us to specify distances at which a blur starts and reaches the maximum value.

- World is now reflected by default.
- Shader validation algorithm has been improved.

If material cannot be rendered on low-end devices, it is replaced by error (pink) material in debug and it is removed in production.

Fixes

- Inversion vertex group length fix.

The inversion operator of HAIR particle system for vertex group length has been fixed.

- Fixed normal rotation for transformed object in Normal Editor.
- Fixed rare engine crash occurred during scene loading if logic nodes were used in a scene.
- Fixed material panel in the Viewer app. It was disabled for some materials, which are allowed to edit.
- Fixed engine crash on mobile devices.
- Fixed flickering on mobile browsers.
- Dynamic water object loading crash has been fixed.
- Fixed normalmap influence on reflections for stack materials.
- Disabled gray highlighting when tapping in WebPlayer on iPad.

v16.07

New Features

- Optimized Particle system rendering.

Now WebGL instancing capabilities are used (provided by the ANGLE_instanced_arrays extension or WebGL 2.0) to render Object-type particles. This type of rendering is more memory efficient and, in some cases, also improves rendering performance.

- Reduced input latency on mobile devices.

Now the engine ignores mouse events that represent actions that already have been handled by internal Blend4Web touch-event handlers on mobile versions of Chrome, Firefox, Safari. It reduces delays in user actions.

- Audio system improvements.

Automatic audio context creation. The Audio checkbox has been removed from the addon. If necessary, scene audio context is created automatically.

Doppler effect implementation. In recent versions of WebAudio spec Doppler effect was removed. It's now supposed that application developers should implement this effect themselves. From this release you can use in-engine implementation. A new option called Enable Doppler has been added, replacing the deprecated Disable Doppler.

Reworked audio interface. New settings have been designed to be as close as possible to the native Blender settings. This includes support for such settings as Speed, Doppler and Distance Model.

New Auto-play speaker option. This option enables speaker playback by default.

Preliminary support for complex audio loops. Using new Loop Start and Loop End options as well as `loop_stop` API method you can create complex audio loops, which include start, loop and stop sections in one audio buffer. For example, you can create basic ADSR (attack, decay, sustain, release) envelopes using this new API.

- Support for multi-touch selection in selection sensor.

Now selection sensors are able to use multi-touch selection in [Event-Driven Model](#).

- Node materials animation improvements.

Now any node animation can be applied to any node material or its nested node groups. Also, there is a new `apply_ext()` method that allows specifying material or a node group that is to be animated.

- A new method has been added into the `preloader` module: `create_preloader`.
- Configuration parameters `max_fps`, `max_fps_physics`, `use_min50`, `anisotropic_filtering`, `shadows`, `reflections`, `refractions`, `ssao`, `dof`, `god_rays`, `bloom` and `motion_blur` have been added to the `config` API module.

Changes

- Color picking optimization.

Now color picking uses very narrow frustum and a small framebuffer size (1 x 1 pix). Also, amount of `pick_object` calls has been reduced. This improves performance of selection sensor.

- Depth-of-field (DOF) effect improvements.

DOF effect performance has been increased.

An experimental DoF effect algorithm has been added. It varies the amount of blur depending on depth and produces bokeh effect on blurred objects. New algorithm can be enabled via Bokeh property from the camera properties panel in Blender.

- API changes.

The `create_simple_preloader` method of the `preloader` module has been declared deprecated and will be removed in future releases.

Fixes

- Fixed the broken Canvas Resolution Factor slider in the Scene Viewer.
- Fixed `get_matrix`, `set_matrix`, `get_matrix_rel`, `set_matrix_rel` methods of the transform module.
- Fixed definition of the `resize_to_container` method of the container module.
- Fixed performance regression caused by resizing the canvas.
- Fixed cameras linked from other scenes or dupli-groups not present in the scene.
- Fixed incorrect canvas alpha with Bloom post effect.
- Fixed Viewer Stop All animation button.
- Fixed object picking for stack material.
- Fixed glow effect on Safari.

v16.06

New Features

- Fast Preview improvements.

If necessary, the development server copies all external resources into the tmp directory. This allows previewing scenes which are placed outside the SDK (another directory, flash drive, etc).

- Project Manager improvements.

Support for material library. A new project option has been added allowing users to copy the material library sources into the project directory.

Added the new `--ignore` command property to the `project.py` utility. This option allows users to ignore files during compilation or deployment.

Added the new `check_modules` command to the `project.py` utility. This command allows users to check missing or no longer required modules.

- [Experimental support of the GearVR](#) virtual reality headset.

Support for new WebVR API 1.0 has been added to the engine allowing the use of GearVR devices.

- Support for GIF and BMP textures.

Non-animated GIF and BMP images can now be used as textures.

- Resource Converter improvements.

Now many more media extensions are supported. For detailed information see [the documentation](#).

- Automatic export path determination in Blender addon.

When projects, created using Project Manager, are exported for the first time, a path to the assets directory is automatically resolved.

- Support for parallel animations in the Logic Editor.

It is now possible to apply several parallel animations with the Logic Editor. Previously, only one animation per object was allowed in the Logic Editor. Now, an object can have one animation of each type. The maximum number of possible animations is 8.

- Improved Viewer profiling capabilities.

Added a special mode for profiling objects' rendering time in the Viewer application.

- Lens Flare material property.

A new material property has been appended to the material render panel. Note, that this works only when there is a Sun light source in a scene.

- Clip Start and Clip End options for light sources.

The Clip Start and Clip End properties have been supported for the shadow settings of Point and Spot lamps.

- HTML meta elements in Web Player app.

New HTML meta elements have been added into the WebPlayer HTML templates for compatibility with different social networks.

Changes

- Several material nodes are now using Blender's viewport world space.

- Geometry

The Normal output provides data in Blender's world coordinate space.

The View output provides data in Blender's view coordinate space.

- Texture

The Vector input for environment textures receives data in Blender's world coordinate space.

The Normal output provides data in Blender's world coordinate space.

- Material

The Normal input receives data in Blender's world coordinate space.

The Normal output provides data in Blender's world coordinate space.

- Lamp Data

The Light Vector output provides data in Blender's world coordinate space.

- B4W Vector View

The node's input receives data in Blender's world coordinate space.

- B4W Reflect

The first node's input (used for view vectors) receives data in Blender's view coordinate space.

The second node's input (used for normals) takes data in Blender's world coordinate space.

The node's output provides data in Blender's world coordinate space.

- Now color picking and anchors are disabled in stereo-mode.
- Now keyboard sensors do not active when using browser shortcuts.
- API changes.

The `resize_to_container` method of the `app` module has been declared deprecated and will be removed in future releases. `container` module's `resize_to_container()` method should be used in its stead.

- The Bloom Key option has been renamed Intensity.
- Deprecated functionality.

The following methods: `textures.get_canvas_texture_context()`, `textures.update_canvas_texture_context()` have been removed.

The following logic nodes: Select, Select & Play Timeline, Select & Play Animation have been removed.

- Export errors and warnings now include links to the documentation.
- Proper reporting of incorrect addon directory.

An incorrect addon directory name now generates a corresponding warning message.

- Dealing with cases when water is used without wind.

If the water shader is used without wind, a warning message appears.

- Debug console error messages for unsupported image, video and audio formats have been added.

Fixes

- Fixed decreased performance in stereo-mode.
- Fixed `window.screen.orientation.angle` obfuscation.
- Fixed rendering issue in Firefox browsers with enabled WebGL 2.0 context.
- Fixed right-eye rendering in stereo-mode.
- Fixed rendering for glow materials with the Terrain Dynamic Grass option enabled.
- Removed redundant angular velocity of particles if the Rotation option is disabled.
- Fixed rendering particles with non-node, non-Opaque materials.
- Fixed several GPU memory leaks.
- Fixed engine crash when using wrong callback id in the JS Callback logic node.
- Fixed engine crash in the rare case, when a node material has several Texture nodes with the same texture.
- Fixed the bug which caused the Diffuse Intensity input of the Material and Extended Material nodes to ignore the incoming link.

v16.05

New Features

- Experimental HMD configurator.

Add-on `hmd_conf.js` has been added. It allows users to set up HMD parameters manually. For now, this configurator has been implemented in the Viewer app and can be executed by the button located on the Stereo View panel. For more information see API documentation on the `hmd_conf` module.

- Experimental configurator for gamepads and other game controllers.

Add-on `gp_conf` has been added to API. It contains two main functions: `show` and `hide`. For now it supports controllers and steering devices.

To test this configurator in the Viewer app activate the Gamepad Settings check box on the Input Devices panel.

- New code snippets.

New code snippet demos have been added. Their names are Gamepad, Webcam and Change Image. The first one can help you to integrate gamepads into your project, the second shows you the Camera API in action and the third one is the implementation of the new texture functions.

- A new Vector Transform material node.

This node can be used to convert input data between object, world and camera coordinate spaces.

- A new Empty logic node.

This node can be used to simplify rerouting complex logic node configurations.

- Dynamic replacement of texture images.

A new method `change_image` has been added. It's possible now to replace textures and cubemap bitmaps via API.

- Batching based on a new clustering algorithm.

Batching, that is, the process of combining similar objects for performance reasons, is now based on a new clustering algorithm applied at export. This improves the whole batching process by making it “smarter” and more optimized in comparison with the old regular grid batching.

- Project Manager improvements.

To maintain naming consistency all command line options in `project.py` utility are now specified with `-` symbol instead of underscore, e.g `--engine_type` option has become `--engine-type`.

Added the new `--assets-dest` command property to `project.py` utility. This option allows users to specify a destination directory for storing assets in deployed projects.

- New materials in Material Library

4 new materials have been added to the Pro SDK Material Library: Gold, Ribbed Glass, Silk and Velvet.

Changes

- UI and export usability improvements for objects with no option from the Export Options list selected.

Export Shape Keys is selected automatically after adding a shape key.

Export Vertex Animation is selected automatically after baking vertex animation.

Apply Scale and Modifiers is automatically used during the export process for non-uniform scaled objects, which meet the following requirements:

Has no vertex animation.

Has no parent object.

Has no skinning.

Object physics is disabled.

Apply Modifiers is automatically used during the export process for objects, which have modifiers and meet the following requirements:

Has no vertex animation.

Has no skinning.

- Z sorting in Alpha Sort materials is now performed based on the sizes of objects.

This can lead to more frequent sorting updates which impairs performance, but fixes sorting issues on small objects.

- New frustum culling algorithm.

Now we calculate frustum culling using specific mesh materials instead of objects.

- Gamepad sensor changes.

New button and axis identifiers have been added to the `input` module. Also, gamepad sensors have been renamed as `create_gamepad_btn_sensor` and `create_gamepad_axis_sensor`.

- Entry Point logic nodes with the Run From Script option selected can now be called from API multiple times.

- API changes.

The `create_rotation_preloader` method of the `preloader` module has been declared deprecated and will be removed in further releases.

The `create_advanced_preloader` method of the `preloader` module has been declared deprecated and will be removed in further releases.

The `set_config` method has been added to the `input` module.

The `register_device` method of the `input` module has been declared deprecated and will be removed in further releases.

The `gyro_use` flag of the `config` module has been removed (not needed anymore).

Now functions of the `storage` module have an optional last parameter.

The `is_ie11` method has been added to the `util` module.

- Now the state of a keyboard button is stored in the payload of the keyboard sensor.

For more information see API documentation on the `create_keyboard_sensor` method.

- The link to the troubleshooting page in the WebPlayer “Browser could not initialize WebGL” message has been changed to a more appropriate one.

Now it refers one to the “Problems and Solutions” page in the documentation.

- The documentation has been considerably expanded with detailed descriptions for Anchor and Viewport Alignment features.

Fixes

- Fixed issue with incorrect automatic updates in addon.
- Fixed anchors behavior with logic nodes.
- Fixed JS Callback logic node obfuscation.
- Fixed issue with incorrect sensor removal in `controls.remove_sensor_manifolds` method.
- Fixed issue with incorrect age and compression ratio in distribution zip files.
- Fixed multi-sampling issue in Firefox browsers.

Disabled partially supported multi-sampling in Firefox WebGL 2.0 implementation.

- Fixed error when canvas resolution wouldn't change when Anti-Aliasing quality settings were changed.
- Fixed error when the diffuse intensity value would be applied to shadeless materials.
- Fixed engine crash in the case when `B4W_GLOW_OUTPUT` and `B4W_REFRACTION` nodes were used in the same material.
- Fixed the duplication of the Custom Properties panel in Blender's interface for the Font, Curve, Lattice, Armature and MetaBall data types.
- Fixed some errors in the compiled version of the engine.
- Fixed issues with input and controls modules.
- Fixed issue when node materials using the ColorRamp node were incorrectly batched.
- Fixed incorrect HTTP server shutdown.

v16.04

New Features

- Support for gamepads and controllers.

It's possible now to use gamepads and controllers as input devices. New functions have been added to work with these devices. The first one is `create_gamepad_btn_sensor`. It handles gamepad buttons. The second one is `create_gamepad_axes_sensor`. It handles gamepad axes.

- Node Logic Editor improvements.

Logic node JS Callback has been added. It allows to call custom JavaScript callback defined in your B4W application. Input and output parameters are supported for callbacks.

An option Run From Script has been added to Entry Point node.

Module `logic_nodes` has been added to API. It contains methods to control Node Logic Editor.

Method `append_custom_callback` has been added. It allows to register custom JavaScript callbacks to be used in JS Callback logic node.

Method `remove_custom_callback` has been added. It allows to remove registered custom JavaScript callback.

Method `run_entrypoint` has been added. It allows to activate Entry Point node from API.

- A new function has been added into the `controls` module: `create_hmd_position_sensor`.

This function allows to create a special sensor, which can track the position of an HMD device.

- The options Tilt Angle and Tilt Random are now supported for the Emitter particle systems.
- Reflection for transparent objects.

Before this release only opaque objects could be reflected. Now, transparent objects are also supported.

- Updated math modules.

Math modules `vec3`, `vec4`, `quat`, `mat3`, `mat4` are now based on glMatrix v2.3.1. This new version introduces `hermite`, `bezier`, `slerp`, `fromRotationTranslationScale` and `fromRotationTranslationScaleOrigin` methods.

- A new flag Bake only deform bones has been added to the Skeletal Animation Baker.

Previously, it was impossible to bake bones without the deform flag. This feature can be helpful in cases when some object is parented to the non-deforming bone.

- New GL Debug switch in the Viewer app.

Viewer application now has the GL Debug switch which allows to disable GL error checking. This increases the performance and can be useful while profiling a scene.

- Enable WebGL 2.0 for Firefox browser.
It's now possible to use experimental WebGL 2.0 context in Firefox browser.
- New `prevent_caching` engine configuration option.
This option enables/disables assets caching.
- New physics function has been added.
`apply_force_world` function applies a constant force to the object in the world space.

Changes

- Viewer's HUD Info now has detailed info on each column.
- Node Logic Editor changes.
 - An option to select between Number and String operand types has been added to the Conditional Jump node.
- The activation of the VR mode from now automatically changes the camera type to EYE for better user experience.

Fixes

- Fixed anchors behavior.
- Fixed a cubemap issue for some old NVIDIA GPUs in Firefox.
- Fixed the bug for particle systems with the “Length” vertex group specified when the emitter mesh has the “Apply Modifiers” option checked.
- Fixed the behavior of the `B4W_GLOW_OUTPUT` node for transparent materials.
- Fixed grass map for a single flat grass terrain object.
- Refraction vectors for stack and node materials now use correct view normal.
- Fixed God Rays Blender interface tab.
- Viewer Sky parameters updates have been fixed.
- Fixed incorrect stereo (anaglyph and HMD) rendering in specific cases.
- The Page Param node bug, which always wrote result to the variable R1, has been fixed.
- Updating variable's scope in Node Logic Editor has been fixed.
- Fixed crash with dynamically loaded scenes while using Move Camera logic node.

v16.03

New Features

- Node Logic Editor improvements.

Now you can use global variables for sharing information between threads. This significantly expands the capabilities and allows to create more complex interactive applications.

Logic node JSON has been added. It allows to parse and encode complex JSON objects.

Logic node Get Timeline has been added. It allows to get current frame from NLA or global timeline.

Logic nodes Play Animation and Stop Animation have received environment animation mode.

- New option Update Material Animation for updating animated node shaders in viewport.

This option is useful for those who often use animated shader nodes. Just turn it on to see material animation in Blender viewport.

- Separate Project Manager server from Blender addon.

Starting from this release it's possible to run the Project Manager server as a standalone application using `project_server.py` script. This eliminates the requirement to start Blender to be able to run the Project Manager.

- Add title/description to all Blend4Web demos.

This simplifies searching our demos in Google and other search engines.

- New modules have been added.

The first new mathematical module that was added is called `math`. For more information, please take a look at [the API doc](#).

Also, an `input` module has been added. This module provides an interface for input devices: mouse — `DEVICE_MOUSE`, keyboard — `DEVICE_KEYBOARD`, touchscreen device — `DEVICE_TOUCH`, gyroscope device — `DEVICE_GYRO`, head-mounted device — `DEVICE_HMD`. For more information see API documentation on the `input` module.

- Changed policy for backward compatibility with previous Blender releases.

Starting from this release we will strive to keep the addon compatibility with previous Blender versions.

- HTML links have been supported in an anchor description.

- Objects from secondary scenes(rendered to textures) can now be controlled with logic nodes.
- The Dynamic Grass option was added to the render interface.

There are 3 options available: ON to enable dynamic grass constantly, OFF to disable dynamic grass completely and AUTO to automatically detect objects with dynamic grass.

Changes

- API changes.

The `enable_controls` and `disable_controls` of `app` add-on have been declared deprecated.

Several methods of `controls` module have been declared deprecated: `register_keyboard_events`, `register_mouse_events`, `register_wheel_events`, `register_touch_events`, `register_device_orientation`, `unregister_keyboard_events`, `unregister_mouse_events`, `unregister_wheel_events`, `unregister_touch_events`, `unregister_device_orientation`.

The `create_touch_click_sensor` and `create_hmd_quat_sensor` methods have been added to the `controls` module.

The `get_hmd_device` and `reset_device` methods of `hmd` add-on have been declared deprecated.

Several methods have been added to `util` module: `deg_to_rad`, `rad_to_deg`, `quat_to_ordered_angles`.

The `get_world_by_name` method has been added to the `scenes` module.

- API for camera has been changed.

The `calc_ray()` method was changed. Now it works with parametric lines.

- Static physics behavior has been changed.

Objects, which have material with the Material -> Special: Collision property enabled, can be fully unloaded. Also, these objects can be moved, rotated, etc, as long as they are dynamic.

- Rendering optimizations.

Now we use bounding ellipsoids instead of spheres to frustum cull static objects.

- Node Logic Editor changes.

Node Send Request has been simplified. JSON parsing and encoding routine has moved to new JSON node.

- Material updates, e.g. animated or affected by dynamic lights were optimized.

- Generated water mesh has been enabled on devices without OES_depth_texture support

Fixes

- Fixed webplayer menu behavior.
- Fixed rare development server crash when the response headers contained a specific date (29Feb).
- Fixed Refractions which was set to “ON” in the absence of refractive objects.
- Fixed water material position for dynamic objects.
- Fixed crash for generated water mesh without waves.
- Fixed incorrect output for the TEXTURE node with no texture selected.

v16.02

New Features

- Extended support of Emitter type particle systems.

The support for the node materials that can be used to set particle shading parameters with sequences of basic blocks (including the Particle Info node). This function is available for the particle systems with the Billboard rendering type.

The shader for particles with the Halo type rendering has been rewritten. The support for the Rings, Lines and Star Tips parameters has been added. Maximum particle size limit (caused by the hardware limitations on some platforms) has been removed.

Maximum number of gradient control points limit in the Ramp procedural texture (used for coloring particles) has been removed.

- Extended node material support.

Two new nodes, Vector Curves and RGB Curves, have been added.

The ColorRamp node support has been added. For now, this node supports Linear and Constant type interpolation.

The Particle Info node support has been added. For now, it is fully supported by the Emitter type particle systems with the Billboard rendering type.

- Project Manager improvements.
 - An option to export multiple projects into one archive.

This function makes updating the SDK and migrating projects from one workstation to another significantly easier.

- New project deploying options.

Project deployment is required for uploading finished project to the server, sending them by mail and so on. Starting with the current release, project deployment can be performed directly from the Project Manager's graphical interface. During deployment, projects are packed into a zip archive.

Also, starting with the current release, deployment is available for any type of project (including External type).

- Improvements in the Web Player HTML and Web Player JSON type projects.

Now, during the creation of these projects, you can set the Web Player application parameters such as FPS counter, automatic camera rotation, turning off social network buttons and so on.

Also, projects of these types can now be created with a bundle option which means that all application resources will be located in the same directory.

- Graphical interface improvements.

An option to add and show application icons has been added to make navigation easier and to give users a quick preview of an application in development.

An option to view project info. By clicking the [info] link located at the right side of the project name, a list of detailed information regarding the project can be accessed.

For convenience, the type of a project is now indicated by the prefix at the right side of the link: `player:` for Web Player HTML or Web Player JSON type projects, `dev:` for projects under development and `build:` for compiled (obfuscated) version of an application.

The elements of the Project Manager interface now have pop-up tips.

- The possibility to animate environment settings.

The possibility to animate environment parameters located in the Sky (Horizon Color, Zenith Color), Environment Lighting (Energy), and Mist (Minimum, Start, Depth, Height, Fog Color) tabs has been added. These functions are also available for the NLA animation.

The Animation tab has been added to Blender's World panel. It has Apply Default Animation and Behavior parameters.

For all exported environments, WORLD type meta-object are added to the scenes. These objects can be used to control the animation of the environment settings. You can access these objects the same way you can access any standard object in the scene.

- Camera improvements.

An option to set the limits for vertical movement of camera's pivot point has been added. This function is also available via the API by using the `target_set_pivot_limits()` and `target_get_pivot_limits()` methods.

The new `static_setup()`, `eye_setup()`, `target_setup()`, `hover_setup()` and `hover_setup_rel()` methods have been added for changing and complete setup of the camera behavior. At the same time, the `set_move_style()` has been declared deprecated.

The `target_switch_panning()` method has been added for controlling camera panning, and the `get_view_vector()` method has been added for retrieving the camera's line of sight vector.

The examples of use the camera API are now described in the [corresponding chapter of the documentation](#). This chapter can also be accessed from the [camera.js API module documentation page](#).

- Node Logic Editor improvements.

The Content-Type option has been added to the Send Request node. It can be used to reassign the title field of an HTTP request.

- A new sensor has been added to the controls module.

Gyro Quat (`create_gyro_quat_sensor` method) is the sensor for working with gyroscopes on mobile devices. It can be used to handle device rotation quaternion.

- Experimental UC Browser support has been added.
- User Manual has been reworked and expanded significantly.

Changes

- The Generate Shadows light source parameter has been renamed to Shadow and now also enables shadow rendering in the Blender Viewport.
- Design of the SDK main page has been changed.

Project list is now located in the Project Manager. Links to run frequently used applications, Viewer and Code Snippets, have been added.

- The `get_coords_x()` and `get_coords_y()` can now receive the `target_touches` parameter.

In case of multitouch, this parameter can be used to use only the touches that are inside of the current target element (the `targetTouches` parameter).

- camera API module changes.

The `has_vertical_limits()` and `has_horizontal_limits()` methods have been declared deprecated. The `has_vertical_rot_limits()` and `has_horizontal_rot_limits()` are recommended to use instead of them.

- Changes in the naming rules for the files of the projects under development.
Now, the HTML files of the projects under development (located in the `apps_dev` directory) do not include the `_dev` suffix in their names. To distinguish these projects from the compiled ones, prefixes has been added to the Project Manager.
- When you open the SDK main page, presence of the local development server is checked. If it starts from the local file system, an appropriate warning is shown.

Fixes

- Incorrect behavior of the `canvas_resolution_factor` engine parameter on Apple iOS devices has been fixed.
- Engine error that occurred in case of absence of the selected object in the Show Object and Hide Object logic nodes has been fixed.
- The incorrect coordinate rounding along the Y- and Z-axis while using variables as parameters in the Transform Object logic node has been fixed.
- Node logic blocking in case some nodes are not linked with the Entry Point node has been fixed.
- The issue with the rendering of dynamic objects the RTT-scenes has been fixed.
- Fullscreen switching issue in the Safari browser has been fixed.
- The issue with the Add-on interface (caused by Emitter type particle systems without a material assigned to the object) has been fixed.
- The Factor output of the `B4W_GLOW_OUTPUT` node in the materials with the Alpha Clip type transparency now works correctly.
- Dupli groups with None duplication type are not exported and not rendered.
- The `append_ray_test()` method now works correctly if its first parameter is an empty object.
- Several water settings has been optimized and fixed.
- Physical objects that have parent object will now correctly update their position in the case the physics is disabled in the scene.
- The behavior of the Camera Data and B4W Vector View nodes for reflected objects has been fixed.
- NLA animation of the RGB node in materials has been fixed.
- Now, HAIR type particle system will not be rendered if the emitter object has the Do Not Render parameter enabled.

- The work of the `auto_rotate()` method for EYE type cameras has been fixed.
- The export of Hair type particles from non-active scenes in Blender has been fixed.
- Runtime libraries for Windows have been added to fix the resource conversion error.
- Shader generation error that occurred in case there were more than 10 textures in the material has been fixed.

Known Issues

Starting with this release, the list of all known problems and possible solutions is located in the [dedicated chapter](#).

v16.01

New Features

- Line rendering.

Procedurally generated line rendering is now supported. Special type of object, activated by the Line Renderer option in blender, is provided for it, as well as several API functions: `draw_line`, `get_line_params` and `set_line_params`.
- New logic editor nodes.
 - The Transform Object node can be used to move an object in world, parent or local coordinate space.
 - The String Operation node can be used to perform operations with string constants and variables, like the Math Operation node.
- Simplified SDK installation.

Now, to [install SDK](#), you just need to specify the path to SDK in the File->Scripts section of the User Preferences panel.
- WebPlayer application improvements.

An option to turn off social network buttons located in the bottom-right corner of a loaded scene. To do this, you need to specify the `no_social_attribute` before the application starts.

Escape characters in the Web Player's address bar are now processed correctly.
- Rendering quality improvements for Head-Mounted Displays (HMD).

Means to correct distortion and disable chromatic aberration while using Head-Mounted Displays have been added. Use `set_hmd_params()` function to set up these parameters.

- Two new sensors have been added to the `controls` module.

Touch Rotate (`create_touch_rotate_sensor()` method) sensor can be used to process rotation using two fingers on touch devices.

Callback (`create_callback_sensor()` method) is a sensor whose value is defined by a callback function called every frame.

- Resource converter utility improvements.

The `-verbose` and `-jobs` parameters have been added to the `resource converter utility` `converter.py`, which can be used to output detailed information and to set maximum number of the parallel processes during conversion, respectively.

- Several API methods have been added.

`is_line()` checks whether the object has LINE type.

`is_idle()` checks whether the scene loader has finished all planned tasks.

`hover_switch_horiz_rotation()` can be used to enable and disable horizontal rotation of HOVER type cameras.

- Node tree refresh algorithm has been optimized.

Changes

- Using cubic reflections has been simplified.

Cubic reflection is now rendered from the object's geometric center and not from its Blender origin point. Also, flat reflection is no longer rendered when rendering cubic reflection, which caused artifacts before.

- Changes in API.

The following methods have been added to the `camera` module: `get_vertical_axis()`, `set_vertical_axis()`. “EYE” type camera rotation to a “phi” angle is now performed along the vector returned by the `get_vertical_axis()` function.

The `correct_up()` method now accepts the `strict` flag as a parameter. This parameter can be used to align camera codirectionally with the `y_axis` vector and not simply parallel to it.

`eye_get_vertical_limits`, `eye_get_horizontal_limits`, `target_get_vertical_limits` and `target_get_horizontal_limits` methods can now return limits set in both world and local coordinate spaces. This can be defined by the `local` parameter.

- Logic node changes.

The nodes have been separated into categories.

- An option to select between Number and String variable types has been added to the Variable Store node.

- An option to use string variables to store the entire body of the server request and response has been added to the Send Request node.
- Deprecated Mass Reexporter tool has been removed.

The Mass Reexporter tool panel has been removed, as automatic scene reexport function is already present in the Project Manager (re-export scenes operation).

- Deprecated functionality.

The following methods: `mouse.enable_mouse_hover_glow()`, `mouse.disable_mouse_hover_glow()`, `anim.get_actions()`, `anim.get_current_action()`, `anim.set_current_frame_float()`, `anim.get_current_frame_float()`, `anim.get_frame_range()`, `anim.cyclic()`, `anim.is_cyclic()`, `anim.update_object_animation()`, `controls.remove_sensor_manifolds()`, `main.redraw()`, `scenes.set_glow_intensity()`, `scenes.get_glow_intensity()`, `scenes.apply_glow_anim()`, `scenes.apply_glow_anim_def()`, `scenes.clear_glow_anim()`, `scenes.set_glow_color()`, `scenes.get_glow_color()`, `sfx.speaker_play()`, `sfx.speaker_stop()`, `sfx.speaker_playback_rate()`, `sfx.get_speakers()`, `trans.set_rotation_quat()`, `trans.set_rotation_quat_v()`, `trans.get_rotation_quat()` have been removed.

The `set_camera_move_style()` method and `SPACE_WORLD` and `SPACE_LOCAL` constants have been declared deprecated.

The `has_vertical_limits()` and `has_horizontal_limits()` methods have also been declared deprecated. The new methods `has_vertical_rot_limits()`, `has_horizontal_rot_limits()`, `has_vertical_trans_limits()` and `has_horizontal_trans_limits()` have been added to replace them.

Fixes

- Positioning and flickering of the particle systems with world coordinates have been fixed.
- Front Facing for cubic reflections has been fixed.
- Stereo mode rendering errors have been fixed.
- Incorrect positioning in the child object animation has been fixed.
- Scene loading freeze in the Safari browser while using .ogg audio files with Background Music type speakers has been fixed.
- The Move Camera node bug, which disabled Duration parameter after .blend file reopening, has been fixed.
- System crash while exporting particle system with complex mesh emitter has been fixed.

- The Switch Select node error that led to incorrect switches has been fixed.
- Several camera limit rendering issues in the Blender viewport have been fixed.
- The issue with exporting materials attached directly to the object and not to the mesh has been fixed.
- The RenderCallback function set by the `set_render_callback()` method has been fixed.

The RenderCallback function are now called right before rendering the current frame, so the scene and objects are up-to-date.

- Issues with rendering shadows from multiple light sources of different types (such as POINT and SUN) have been fixed.
- Environment texture rendering while using the texture as the world map and in a stock material at the same time has been corrected.

Known Issues

- Problems with updating of the add-on.

It's strongly advised to restart Blender after installing a newer version of Addon/SDK.

- NVIDIA 331 driver in Linux can cause WebGL errors.
- Changed texture filtering on some platforms.

An incorrect texture filtering was disabled on iPad and Internet Explorer for materials with Alpha Clip type of transparency.

- Some devices with Mail GPU require manual WebGL activation in browser settings.
- For the local development server to work on Apple macOS and Blender 2.76, you may need to install [Python 3.4](#). This is due to a bug in Blender <https://developer.blender.org/T46623>. This bug has been fixed in Blender 2.76b, so updating it is advised.
- Skeletal animation can work incorrectly while using Nouveau drivers.

v15.12

New Features

- Support for shadows from multiple sources.

Support for shadows from multiple sources has been added. This feature can be used to greatly improve the realism of scenes lit by multiple light sources. Its functions and limitations are described in the [documentation](#).

- [Experimental support of the HMD \(Head-mounted display\)](#).

Experimental support for the head-mounted displays with the WebVR API has been added. For now, using this technology requires a web browser with WebVR support and an Oculus Rift device. More details in the documentation.

- Aligning objects with the camera in the viewport.

The new Viewport Alignment option can be used to attach objects to the camera in the viewport. This feature can be used to create UI elements attached to the center, edge or corner of the screen. Unlike parent-child alignment, the position of an aligned object will automatically change when screen resolution or aspect ratio is changed.

Functionality of the `append_stiff_viewport()` method used for Stiff Viewport constraint has also been expanded.

- An option to show camera limits in Blender viewport.

To make the task of setting camera limits up simpler, the Display limits in viewport option has been added to the Data panel of the camera object. When enabled, it will show the limits right in the Blender viewport. Default settings of the limits has also been changed.

- Anaglyph rendering improvements.

New anaglyph rendering algorithm has been implemented. It has better color rendering. Also, plane of convergence of the left and right image for a TARGET type camera will now be calculated automatically based on a point around which the camera is rotated.

- New logic editor nodes.

- Move To: Can be used to move an object to another object.
- Console Print: Can be used to print various information (including variables values) to the web browser console.

- A Stereo View button has been added to the Web Player.

Can be used to switch to the HMD mode (if the web browser supports this technology) or to anaglyph mode.

- New methods for working with objects.

The new methods `get_selectable_objects` and `get_outlining_objects` have been added to make working with objects simpler.

- Dynamic objects can now be deleted.

Before, only objects copied by the user could have been deleted.

- The option to choose an annotation of an object based on the canvas coordinates has been added.

The `pick_object` function now returns the object's annotation, if the object is present in the sent coordinates.

- A new method to initialize media resources for mobile devices has been added.

Before, forced canvas block was used as a workaround of the mobile browsers restriction of loading media resources (video and audio), and a user had to click a popup icon to start the application. Now, you can manually initialize media resources by using `activate_media` method. This function can be useful if the application already have elements that require user input, such as Start button, sound mute button and so on.

- New sensor manifold type - CT_POSITIVE

The new CT_POSITIVE sensor manifold type activates event handler if the logic function result isn't zero.

Changes

- The Fast Preview button has been duplicated in the UI low panel.

This button can be used to preview the scene without switching to the Development Server scene settings panel.

- Canvas texture API has been changed.

Now working with a canvas texture is simpler. New methods `get_canvas_ctx` and `update_canvas_ctx` have been added. The `get_canvas_texture_context` and `update_canvas_texture_context` methods have been declared deprecated and are not recommended to use. The Source ID interface field for the canvas texture has also been removed.

- Wrong behavior of the shadows from Alpha Clip materials has been fixed.

Incorrect behavior of the shadows casted by the objects with Alpha Clip materials without transparency value has been fixed.

Fixes

- Incorrect physics of a copied object has been fixed.

Incorrect physics behavior of a copied object (which occurred if the object was moved before being added to the scene) has been fixed.

- Incorrect fog behavior if a water plane was added to the scene has been fixed.
- Misplacing of the Blender interface panels in basic scene for a new project has been fixed.
- Cubemap rendering issue on the NVIDIA GeForce 200 series GPU has been fixed.
- Engine workflow on iPhone (4, 4S and 5), iPad (2nd, 3rd and 4th generations) and iPad Mini (1st and 2nd generations) has been improved.
- Incorrect rendering of the shadows casted by billboard objects has been fixed.

Known Issues

- Problems with updating of the add-on.

It's strongly advised to restart Blender after installing a newer version of Addon/SDK.

- NVIDIA 331 driver in Linux can cause WebGL errors.
- Changed texture filtering on some platforms.

An incorrect texture filtering was disabled on iPad and Internet Explorer for materials with Alpha Clip type of transparency.

- Incorrect Depth texture behavior on Windows OS.

Depth textures are unstable on Google Chrome 32 bit on Windows. This problem is fixed in the beta version of the browser.

- Some devices with Mail GPU require manual WebGL activation in browser settings.
- For the local development server to work on Apple macOS and Blender 2.76, you may need to install [Python 3.4](#). This is due to a bug in Blender <https://developer.blender.org/T46623>. This bug has been fixed in Blender 2.76b, so updating it is advised.

v15.11

New Features

- Initial support of WebGL 2.0 technology.

New API features are automatically provided with compatible browser and hardware

- New Logic Editor Features:

- Camera animation.

The option to smoothly change camera's position has been added to the Move Camera node.

- New: behavior animation.

The Play Animation node can now add Behavior animation to an object.

- New Stop Animation node

Can be used to stop object's animation

- New Stop Sound node

Can be used to stop a speaker's sound playback

- New Stop Timeline node

Can be used to stop NLA animation

- MSAA support

This antialiasing algorithm is used in systems compatible with WebGL 2.0. For now, it allows the highest image quality on the ULTRA settings by using 16x MSAA algorithm.

- Viewer interface improvements.

A Home button has been added. When pushed, it will open the basic scene specified in the application's URL parameters, or, if there isn't any, a placeholder scene with Blend4Web cubic logo will be opened.

The Reset button has been moved to the right side of the application's upper panel and will now reset not only internal but also URL parameters (such as loaded basic scene) of the Viewer.

The Auto View Mode button used for automatic walkthrough of all scenes has been moved to the Tools & Debug panel.

- High precision rendering performance measure mechanic.

Using the WebGL extension `EXT_disjoint_timer_query` allows high precision timers to be created, which can be used to measure the performance of GPU operations. With the activation of the debug mode in the Viewer ('HUD Info' option in the Tools & Debug panel), the time (in milliseconds) the GPU needs to render part of the scene (subscene) is shown in the last column of the debug information.

- Web player improvements.

Now, the cursor changes appearance while the camera is moving.

- There are numerous additions and improvements in the documentation.

Changes

- The Copy Cursor Location button has been renamed to Look At Cursor, and its behavior has also been changed.

Now, by pressing this button, you can rotate the camera to the pointed direction.

- Changes API.

For compatibility with third-party applications, `set_matrix`, `get_matrix`, `set_matrix_rel` and `get_matrix_rel` methods has been added, but for optimization purposes, using `set_tsr`, `get_tsr`, `set_tsr_rel` and `get_tsr_rel` methods is recommended.

Now the `hide_object` and `show_object` functions will, by default, change the visibility of an object and all its children. To change only the current object's visibility, `ignore_children` parameter with true value should be sent.

The following method has been declared deprecated and will be removed in further releases: `create_sep()` (`tsr` module). `tsr` module's `set_sep()` method should be used instead of it.

`camera` module API has been changed considerably. Deprecated methods `is_camera()`, `rotate_pivot()`, `rotate_hover_cam()`, `get_hover_cam_angle()`, `set_hover_cam_angle()`, `translate_hover_cam_v()`, `set_eye_params()`, `rotate()`, `get_angles()` have been removed. The following methods have also been declared deprecated: `set_look_at`, `rotate_eye_camera`, `rotate_target_camera`, `set_trans_pivot`, `zoom_object`, `set_pivot`, `rotate_hover_camera`, `get_hover_cam_pivot`, `get_eye`, `get_pivot`, `hover_cam_set_translation`, `set_hover_pivot`, `get_hover_angle_limits`, `get_cam_dist_limits`, `apply_vertical_limits`, `clear_hover_angle_limits`, `apply_hover_angle_limits`, `apply_distance_limits`, `clear_distance_limits`, `get_vertical_limits`, `apply_horizontal_limits`, `get_horizontal_limits`, `clear_vertical_limits`, `clear_horizontal_limits`. In their place, we recommend using methods starting with camera type prefix: `target_...`, `eye_...`, `static_...`, `hover_...`. Methods `set_velocity_params` and `get_velocity_params` have also been declared deprecated, and instead of them, using `set_velocities` and `b4wref:camera.get_velocities`, respectively, is recommended.

For working with the distance between the current TARGET or HOVER camera and the pivot point, `target_get_distance`, `target_set_distance` and `hover_get_distance` methods have been added

- In the Viewer, Play All and Stop All buttons have been added for playing and stopping all animations, respectively.
- Logic editor changes:
 - Select node and Select & Play Animation and Select & Play Timeline nodes based on it, have been declared deprecated. As a replacement, using the combination of Switch Select, Play Animation and Play Timeline nodes is recommended.
 - SDK examples, which were using aforementioned deprecated nodes, have been updated.
 - For the logic nodes behavior transparency, Cyclic NLA option has been switched off.
- Behavior of the HOVER camera in the absence of limits has been changed.
 - HOVER camera will now be hanging over pivot point at a fixed distance and fixed angle.

- Glow effect changes.

Light sources will now influence [glow effect](#), if Material or Extended Material nodes are present.

Fixes

- Project Manager errors were fixed.

Links to the developer's applications included in the project are now showing in the list.

Formatting in the compiled applications' HTML files has been fixed.

- Skinning on the mobile platforms has been improved.

- Addon's translation files connection error has been fixed.

An error that could have happened on some devices because of system's inability to process addon's translation files, has been fixed.

- Particle objects shadow casting improvements.

Fix behavior of the shadows casted by "Hair" particles (used as billboards) while changing the size of the main canvas.

- Engine workflow on the Mali 400 series GPU has been fixed.

- Flat reflections and fog for `double_sided_lighting` materials have been fixed.

- Local Storage limited quota on the Safari browser in the incognito mode no longer causes error.

- Functionality of the Render Glow Over Transparent Objects' option in the Blender's [glow settings](#) has been restored.

- Several video texture playback issues have been fixed.

Known Issues

- Problems with updating of the add-on.

It's strongly advised to restart Blender after installing a newer version of Addon/SDK.

- NVIDIA 331 driver in Linux can cause WebGL errors.

- Changed texture filtering on some platforms.

An incorrect texture filtering was disabled on iPad and Internet Explorer for materials with Alpha Clip type of transparency.

- Incorrect Depth texture behavior on Windows OS.

Depth textures are unstable on Google Chrome 32 bit on Windows. This problem is fixed in the beta version of the browser.

- Some devices with Mail GPU require manual WebGL activation in browser settings.
- You may require to install Python 3.4 on the systems with Apple macOS and Blender 2.76. This issue is connected with Blender bug <https://developer.blender.org/T46623>.

v15.10

New Features

- New Project Manager features.

It is now possible to export/import projects. This simplifies updating projects to newer versions of the SDK and also allows users to run and debug projects on various platforms. You can also share your projects with other developers in an efficient way.

You can now create WebPlayer JSON and WebPlayer HTML projects. Such options allow you to create projects specifically for WebPlayer app which do not require writing any additional code.

To simplify navigation between your projects, two features have been added. The first one is the possibility to sort projects by name, and the second one is the possibility to show/hide SDK's stock projects.

It is now possible to remove projects from the SDK.

Improved Windows support. We now provide a Windows version of Java with the SDK, so you are no longer required to install any additional dependencies in order to build projects.

- Anti-aliasing improvements.

A new option AA Quality has been added to the Render > Anti-Aliasing panel in Blender. This option allows you to select quality level of **anti-aliasing**. Also, the anti-aliasing algorithm is now based on FXAA 3.11, which increases both quality and performance especially for HIGH and ULTRA quality profiles.

- Node Logic Editor improvements.

- Move Camera node.

Allows you to specify the camera's location and target.

- Play Sound node.

Allows you to play back sound from a selected speaker.

- Switch Select node.

This node works the same way as Select but allows you to select multiple objects in more flexible and convenient way.

- Support for random numbers generation has been added to the Math Operation node.
- Support for POST requests in the Send Request node.
- Repeat mapping type for non-power-of-two textures is now supported.

Repeat mapping type is now supported for non-power-of-two textures (i.e. textures whose dimensions are not 256, 512, 1024, etc). Also the mipmapping technique (trilinear filtering) is also supported for such textures.
- Automatic rescaling of textures is now performed if their dimensions exceed platform limits.

In the cases when texture dimensions exceed platform limits, textures will be automatically downscaled. The only exception is compressed textures.
- New button Fast Preview to perform fast scene previews.

The button is located on the Render > Development Server panel.
- Support for Intensity and Color animation of lamp objects.

It is now possible to animate intensity and color of lamp objects, both when using conventional and NLA animation.

Changes

- Project Manager interface has been improved.

Improved UI, added Development Server > Project Manager button to run the Project Manager in the default browser.
- Speakers functioning has been improved.

The `is_play()` method now correctly notifies about finishing sound playback, with a minimal delay.
- Some new export warnings have been added.

Upon exporting some objects, their type will be changed to EMPTY in case of empty geometry or in the case when the sound file for the SPEAKER object does not exist. Messages on such facts are now displayed in the browser console.
- Displaying the object selector for logic nodes has been improved.
- Gamma correction behavior in node materials has been changed.

[Gamma correction in node materials](#) is now performed differently because of changes in Blender 2.76.
- Changes API.

The `resize` method is now deprecated and will be deleted from the `main` module. The `resize` method from the `container` module should be used instead.

Fixes

- Project Manager errors were fixed.
- Stability on mobile devices has been improved for scenes with too many lamps.
- Stability on Unix systems has been increased.

Stability on Unix-systems using AMD GPUs and open source drivers has been increased.

- An error related to annotations being added to a scene has been fixed.

Fixed an error which occurred when annotations without the Object -> Meta Tags property were added to the scene.

- Fixed an error with incorrect audio playback during browser tabs switch.
- Several video texture errors have been fixed.
- Fixed an error occurred when an empty node group was used inside a node material.
- Fixed an error with a particle system which use an object with LOD as a particle.
- The Delay node error when using a variable as a parameter has been fixed in the logic editor.
- Fixed an error in the logic editor which occurred upon deleting an Entry Point node.
- Fixed an error in the logic editor with duplicated variables in the dropdown list.
- Fixed an error in scenes which use both the Play Animation logic node and the switched off NLA flag.
- The behavior of the Math->Power and Gamma shader nodes has been fixed and is now consistent with Blender.

Known Issues

- Problems with updating of the add-on.

It's strongly advised to restart Blender after installing a newer version of Addon/SDK.

- NVIDIA 331 driver in Linux can cause WebGL errors.
- Changed texture filtering on some platforms.

An incorrect texture filtering was disabled on iPad and Internet Explorer for materials with Alpha Clip type of transparency.

- Incorrect Depth texture behavior on Windows OS.

Depth textures are unstable on Google Chrome 32 bit on Windows. This problem is fixed in the beta version of the browser.

- Some devices with Mail GPU require manual WebGL activation in browser settings.
- You may require to install [Python 3.4](#) on the systems with Apple macOS and Blender 2.76. This issue is connected with Blender bug <https://developer.blender.org/T46623>.

v15.09

New Features

- Project Management.

A new project management system allows one to:

- show the list and info about existing projects
- execute apps, load scenes in the Viewer app, load scene files in Blender.
- create and configure new applications, optionally using prefabricated app/scene starter files to simplify creating new applications
- build applications, create versions suitable for deployment on a server
- convert application resources (textures, sounds and video) to alternative formats
- automatically reexport all application scenes including json and html files

There are two methods to manage projects: by using `project.py` utility which has a simple self-documented command line interface, or using a GUI web application, which is run on the developer server. This server does not require any additional configuration and as before is executed by the Open SDK button in Blender.

The project management system works on all operating systems, however, some operations may require additional dependencies. To find out more about the configuration of this system check out the following [topic](#) in documentation.

- Controlling armature bones.

Enhanced features to control armature objects.

Added a new `armature` module which includes methods to get or assign bone positions both in armature coordinate space (`get_bone_tsr()`, `set_bone_tsr()`) and in bone-relative coordinate space

(`get_bone_tsr_rel()`, `set_bone_tsr_rel()`). By using these methods, it's possible to program armature behavior. For example, animate interactive characters or create sophisticated armature-based objects with multiple moving parts.

Support for COPY_TRANSFORMS constraints on bones. This allows bones to follow movements of any objects located on the scene, e.g create physically simulated “Ragdoll” objects.

- New logic editor nodes.
 - Play Animation: play animation of an object.
 - Send Request: send HTTP GET request to a server and parse its response.
 - Inherit Material: copy material properties from one object to another.
 - Set Shader Node Param: change outputs of Value and RGB shader nodes.
 - Delay: delay program execution for a given amount of time.
 - Apply Shape Key: change shape key value for an object.
 - Outline: control object outlining effect.
- New Allow NLA settings for video textures, which enables/disables NLA-animation for a given texture.
- New features in the material module.

New APIs added `set_specular_color_factor` and `get_specular_color_factor`.
- New features on the SDK index web page.

Index page of the SDK now contains a Tools section, which in turn includes Project Manager and WebGL Report tools.
- Web player improvements.

A new optional alpha setting has been added, which is used to set rendering canvas transparency. The [Outline on Select](#) feature is now supported.
- New app compilation type update has been added to `project.py` utility.

This type of app compilation allows one to update the engine inside a project directory. The app itself is not compiled with this option. The feature is useful for basic applications and tutorials.
- New features in the app module.

A new param `disable_zoom` has been added to the `enable_camera_controls()` method. This parameter disables zoom movements of the camera.

A new method `queue_animate()` has been added to the `app` module.
- New features in the scenes module.

A new method `has_picking_subs()` has been added to the `scenes` module.

- New features in the debug module.

A new method `fake_load()` has been added to the `debug` module.

Changes

- Add-ons (such as `app`, `mouse` and others) are now a part of the compiled engine version:
 - `b4w.min.js` - advanced optimization (`b4w.full.min.js` previously)
 - `b4w.simple.min.js` - simple optimization
 - `b4w.whitespace.min.js` - optimization of whitespaces used in the code

The correct version is chosen according to the `application compilation` settings.

- Node Logic Editor improvements.
 - Play -> Play Timeline; Select & Jump -> Select, Register Store -> Variable Store nodes were renamed.
 - Now it is possible to create user-defined variables apart from register-variables.
- The rarely used combine engine building method was removed.
- Documentation for the `resource converter` was revised.
- Documentation for the `addon translator` was revised
- The export of UV-layers and vertex colors was changed.

Now the behavior of UV-layers and vertex colors resembles that in Blender even more.

- Support for NLA-animation and video-textures was extended. They act similar to those in Blender.
- A message about the lack of animation channels was added to the `export errors`.
- A non-critical export error on the selection of unsupported Render Type in particle systems was added.
- The Specular Color Factor property is now being inherited during material inheritance (`inherit_material` API method).
- Changes API.

The following methods are marked as deprecated and will be removed in future releases: `is_camera`, `is_mesh`, `is_armature`.

The following methods of the `objects` module should be used instead: `is_camera`, `is_mesh`, `is_armature`

Also, there are the following new methods: `is_speaker`, `is_lamp` and `is_empty`.

The `get_object_by_dupli_name_list` method now returns null, if the `name_list` parameter is given incorrectly. The `get_object_name_hierarchy` method for receiving the full list of names with respect to object duplication was added. The value returned by this method is a valid input for the `get_object_by_dupli_name_list` function.

The `wireframe_mode` parameter in the `set_debug_params` method now has a value of one of the following constants: `WM_NONE`, `WM_OPAQUE_WIREFRAME`, `WM_TRANSPARENT_WIREFRAME`, `WM_FRONT_BACK_VIEW`, `WM_DEBUG_SPHERES`.

- NLA Animation Behavior for dynamically loaded scenes changes.

If there are objects with NLA-animation in such scenes, they are now influenced by the NLA settings of the main scene. Previously, such animation was not supported.

- The refactoring of the objects' internal structure was continued.
- Export error was added.

Now when an object with a type other than "Mesh" is used as a "Hair" particle, a non-critical export error will occur.

- Licensing information was added to the distribution sources.
- Now texture slots with Environment Maps containing video textures are not exported.

A non-critical export error, stating that a video cannot be used as an Environment Map, was added.

Fixes

- Render Above All option now works correctly with node materials.
- Fixed `remove_object()` function.
- "Hair" particles have become more stable.

Fixed the bug that appeared while using an object with the "Hair" particle modifier.

- Improved Windows Phone support.

- Fixed the bug that appeared while copying physical objects.
- Fixed the bug with Orco vector output when an object has zero scale in one or several axes.
- Fixed the bug in particle emitters: it appeared when an object with physics settings was chosen as a particle.
- Fixed the bug in NLA animation: it could not start from a frame other than 0 before.
- Fixed Lamp Data behavior: previously the information about light sources was not always refreshed during scene loading.
- Fixed the bug in calculations of Normal vector output in node Geometry on the back side of a polygon.
- Fixed the bug of Orco vector output in node Geometry that appeared if object was translated relatively to its origin in Blender.
- Fixed calculation of the last frame of NLA animation for video textures.
- Fixed the engine bug related to different setting combinations of objects' selection and outlining.
- Wind bending effect has become more stable.
- Fixed bugs in Alpha Clip materials rendering.
- Fixed specular texture reproduction during material inheritance.
- Fixed the bug with light sources in apps with multiple scenes.

Known Issues

- Problems with updating of the add-on.
 - It's strongly advised to restart Blender after installing a newer version of Addon/SDK.
- NVIDIA 331 driver in Linux can cause WebGL errors.
- Changed texture filtering on some platforms.
 - An incorrect texture filtering was disabled on iPad and Internet Explorer for materials with Alpha Clip type of transparency.
- Some devices with Mail GPU require manual WebGL activation in browser settings.

v15.08

New Features

- Node-based logic editor.

This new logic editor allows to add interactivity to your apps more easily by using a tree of connected nodes. The NLA Script tool which was previously used for this purpose has been removed, the old scripts are automatically converted to the newer format during blend file loading.

- Support for various shading models inside MATERIAL and MATERIAL_EXT nodes.

Now the diffuse and specular shading models are selected based on materials inside such nodes. This is different from the previous behavior when the shading was the same for all nodes and was assigned by node material itself. This feature allows mixing different basic materials (non-textured) inside node-based ones.

- Improvements in transformation API.

New transform methods to perform relative objects transformations: `set_translation_rel()`, `set_translation_rel_v()`, `get_translation_rel()`, `set_rotation_rel()`, `set_rotation_rel_v()`, `get_rotation_rel()`, `set_scale_rel()`, `get_scale_rel()`, `set_tsr_rel()`, `get_tsr_rel()`.

Methods without `_rel` suffix now always perform transformations in world coordinate space, even if they are children of other objects.

Also new methods to perform local rotations `rotate_x_local()`, `rotate_y_local()`, `rotate_z_local()` have been added to transform module.

- Improved support for OS Windows.

Support for OS Windows in `resource converter`. Now Windows users can create cross-browser applications which use media resources in different formats. Also the `application builder` app can also be run in Windows.

- Support for the Microsoft Edge browser.
- Support for physics simulation in the main (non-worker) browser process.

This feature is useful for eliminating delays in physics calculations in some mobile browsers. Earlier, all simulations took place in separate Worker threads. The feature is controlled by `physics_use_worker` parameter of the engine's initialization.

- Support for bounding box recalculation.

A new method `update_boundings()` has been added to the `objects` module. This method performs recalculations of the object's boundings such as box, sphere, ellipsoid, cylinder, cone and capsule.

- Documentation improvements.

A new theme has been selected for the user manual. This theme improves documentation readability on displays with different screen resolutions.

Greatly improved and extended documentation for `application developers`.

- New APIs in camera_ anim module.
New methods `stop_cam_moving()` and `stop_cam_rotating()` in the `b4wmod:camera_ anim` module.
- Binary compatibility checks.
Now the version checks between `.bin` and `.json` files and the current engine version are performed while scenes load.

Changes

- Changes in node material editor.
Custom shader nodes have been moved from the Group menu to the Blend4Web menu. Also, an error with duplicated menu entries has been fixed.
- Refactoring of object structure.
Complete refactoring of an object structure has been initiated. Object structures now have strong typing and include less redundant data. This improves overall engine performance.
- Changes API.
The following methods are now deprecated and will be removed in future engine releases: `get_object_dg_parent()` (scenes module), `get_parent()` (constraints module). Instead, it is recommended to use `get_parent()` and `get_dg_parent()` from the `objects` module.
- Improved interaction between the development server and multiple Blender instances.

Fixes

- Fixed a compilation error in the `project.py` utility when a project is compiled to some external directory.
- Fixed a web server error which could arise due corrupted Windows registry.
- Fixed an export freeze for some corrupted `.blend` files.
- Fixed incorrect non-uniform scale warnings upon exporting Metaball objects.
- Fixed an error with Auto View mode in the Viewer app if were an empty scene category.
- Fixed rendering of dynamically loaded materials if they have the same name.
- Fixed an export error for scenes using Copy Transforms constraints.
- Fixed an error with rendering depth textures in the Microsoft Edge browser.
- Fixed a bug with touch events in the Microsoft Edge browser.

Known Issues

- In the logic editor, some of looped links are highlighted in red. This issue has only cosmetic effect and can be safely ignored.

v15.07

New Features

- Support for Alpha Clip transparency for node materials.

It is now possible to specify a transparency mask for Alpha Clip materials using node logic.

- Support for soft particles.

The new property Soft Particles has been added to the Render panel of the Emitter particle system. When activated, this property renders smooth edges near opaque objects located on the scene. This effect is available only for materials with Alpha Sort, Alpha Blend or Add type of transparency.

- New preprocessor for shader instructions.

This new preprocessor has more straightforward architecture and works faster, which, in turn, greatly reduces overall scene loading time, especially in cases with many different shaders.

- Improved Viewer app performance.

Performance problems caused by event handling in jQuery Mobile library have been fixed.

- Zero level property for HOVER cameras.

This property represents a Z coordinate of the reference plane in which the camera's pivot point is located.

- New sensor manifold type: CT_CHANGE.

Along with CT_CONTINUOUS, CT_TRIGGER, CT_SHOT and CT_LEVEL manifold types the new CT_CHANGE type can now be used. This type allows to execute a manifold's callback right after any of the sensors' values in the manifold has been changed.

- New APIs in camera_anim module.

New API methods such as `move_camera_to_point()`, `rotate_camera()`, `is_moving()` and `is_rotating()` have been added to module `camera_anim`.

- A new option to assign materials to objects.

Until now it has not been possible to assign materials on objects using Object property. Now, this feature is supported.

- Support for external requests to the local development server.

This feature is enabled by the Enable external requests property in addon preferences.

- New method `clear_animation()` in the `time` module.
- New camera APIs.

APIs of `camera` module has been extended by `get_vertical_limits()` and `has_vertical_limits()` methods which are used to get or check the camera's vertical rotation and translation limits.

- Documentation improvements.

New user manual design optimized for devices of all kind.

The differences between coordinate systems used in Blender and Blend4Web are now specified in documentation.

- Support for addon `i18n`.

This feature allows translation of addon interface to different languages. The translation into Russian is almost complete.

Changes

- Various usability improvements in the addon interface.
- New `force_container_ratio` option in the `init()` method.
- Simplified usage of water caustics.

Water caustics effect is now activated by the Caustics option located on the material's Water panel.

- New way of evaluating mouse movement sensors.

Now all elements inside the Canvas Container element (e.g Anchors) do not lock mouse events, thus allowing us to prevent glitches during camera movement.

- Option to change quality of reflections.

Now it is possible to choose one of three predefined reflection quality modes: LOW, MEDIUM or HIGH.

- New properties `--project` and `--app` in the `project.py` utility.
- New animation APIs.

New methods to simplify frame setting:
`set_first_frame()/set_last_frame()`.

- New behavior of plane reflections.

It is now possible to omit specifying the reflection normal by leaving the Reflection Plane option empty. In this case, local Z axis will be used instead.

- New SSAO behavior.

Now there is no need to have shadow casters in the scene to use the SSAO effect.

- New texture anisotropic filtering settings.

There is a new Default value for anisotropic filtering option assigned to textures. By selecting this value you can use the anisotropic filtering specified on the scene. If you need to disable anisotropic filtering on all textures, again, use the setting from the scene.

- New specular alpha shading behavior to match Blender's.
- The physics mask/group, assigned for collision materials, has been extended from 8 to 16 bits.
- New asynchronous shader loader for developer version of Blend4Web.
- Elimination of shaders module.

The methods of this module is now available from the [debug](#) module.

- New script for batch processing exported json/html files.

The scripts reexporter.py and resaver.py have been combined into process_blend.py, which has options for processing exported json/html files.

- Minor refactoring and improvements in API documentation.

Fixes

- Fixed a bug with incorrect Canvas element size appeared on the engine's startup.
- Fixed a lighting bug on objects with the negative Scale option.

This condition is properly handled and reported to the user (in the browser console).

- Fixed a bug with object's vertex animation.
- Fixed a bug with animation played in reverse.
- Fixed an error with incorrect state of Collision and Ray sensors which appeared after deleting physics objects.
- Environment textures with dimensions exceeding the supported ones are now processed correctly.

Now, such textures are not being turned off but rendered in reduced scale instead. Dimensions are reduced synthetically for NVIDIA GeForce 8000 GPUs on Windows Chrome.

- Fixed an issue with incorrectly reported error which appeared while loading scenes with missing camera/world.
- Fixed a Blender startup error with the world missing from the scene.
- Fixed a bug in the Webplayer app when the sound button was missing in some scenes.
- Fixed a bug in the scenes when motion blur is the only effect to appear.
- Fixed the `get_material_extended_params()` method in the `material` module.
- Fixed Firefox Mobile crashes when using shadows. Improved overall stability for this browser.
- Improved reexporter stability.

Known Issues

- Problems with updating of the add-on.

It's strongly advised to restart Blender after installing a newer version of Addon/SDK.
- NVIDIA 331 driver in Linux can cause WebGL errors.
- There is a [bug](#) with video textures on Chrome 43 for Android.

Please update your Chrome browser to Beta or wait until the next Chrome update.
- Fixed issues with the Background Music speakers in the scenes exported to html.

Currently, there is a bug in Google Chrome ([Issue 511251](#)), related to an error with audio file origin. Currently, this issue is partially resolved by our workaround with forced `crossOrigin` attribute on audio sources.
- Changed texture filtering on some platforms.

An incorrect texture filtering was disabled on iPad and Internet Explorer for materials with Alpha Clip type of transparency.

v15.06

New Features

- New add-on user interface.

Add-on interface has been redesigned. It is now activated by the new rendering profile, Blend4Web, which only contains panels and options explicitly supported by the engine. To simplify navigation, the old multi-line Blend4Web panels have been re-grouped into the smaller ones, based on functionality.

Also, there is a new feature to automatically assign graphic effects required for a scene. In particular, shadows, refraction, Glow and Outline effects acquired the new AUTO property which automatically activates them if some objects or materials located on the scene require such effects.

- New normal editor.

The normal editor has been substantially upgraded. Now it is fully compatible with the native Blender datablock used to store normals. This new editor has more efficient UI and also allows to edit split normals.

- Support for new material nodes.

Orco and Local outputs of Geometry node are now supported. There are also some preliminary steps to support RGB Curves, Vector Curves, ColorRamp and Cycles nodes.

- New shading models.

Minnaert/Toon diffuse shaders and Blinn specular shader have been implemented. Thus, starting from this release the engine supports all shading models of Blender.

- Support for Blender 2.75

- Multiple physics improvements.

Code for collision detection has been rewritten. Now it is possible to determine colliding objects, and also the coordinates and the normal at the collision point.

Improved ray casting API. In particular, one can specify an option to perform an automatic cleanup of the ray test object and also another option to cast a ray through multiple objects. As in the case of collision detection, this new API allows to determine the target object and the position/normal of the hit point. There is also a new possibility to cast rays from point to point in global space, without requirement to specify a source object.

Extended possibilities of Collision and Ray sensors.

Support for deleting physics objects and automatic recalculation of collision/ray tests after physics objects have been added/removed.

- A new tool for reexporting multiple scenes.

A new Mass Reexporter tool has been added to addon. This tool allows to automatically reexport all scenes from the specified list of directories.

- Possibility to check for updates.

You can now enable a Check for Updates on Startup option in addon settings to perform automatic checks for the new versions of Blend4Web.

- API to control Motion Blur postprocessing effect.

New methods to control Motion Blur effect `get_mb_params()` and `set_mb_params()` has been added to `scenes.js` module.

- Support for Timeline markers.

To extract frame numbers from timeline markers a new method `marker_frame()` has been implemented in `scenes.js` module.

- New NLA APIs.

A new set of methods: `set_range()`, `reset_range()`, `set_cyclic()` and `clear_callback()` has been added to `nla.js` module. Also, it's now possible to specify callback in `play()` method.

- New API to change Canvas resolution.

To change Canvas resolution it's sufficient to execute method `set()` from `config.js` module with the following parameters: `canvas_resolution_factor` and `value`, where `value` is the new resolution of Canvas. This feature is particularly useful for creating high-definition screenshots.

- Support for Vertex Groups -> Length option in Hair particle system.

- New API documentation.

To document types used by Blend4Web applications we developed a new formal type system. For example, in our old API docs 3D vectors had `Float32Array` type. Now they have formal `Vec3` type. This solution allows us to formulate more clear and intelligible descriptions for API and, more importantly, helps our users to develop more readable and reliable applications.

- New colors API.

To work with colors in efficient way two new modules: `rgb` and `rgba` have been created. They include APIs to create new color vectors and convert them between different profiles.

- Automatic determination of path to SDK.

Addon option `Blend4Web SDK Directory` is filled up automatically, if the addon is located in default `blender_scripts` directory inside SDK.

- API for correct calculation of Canvas 2D coordinates.

For proper manipulations with mouse cursor and touchscreen devices the engine requires correct 2D Canvas coordinates.

Details about calculation and use cases of such coordinates are described in the separate [topic](#).

To support this feature the following methods have been added to engine's APIs: `client_to_canvas_coords()`, `set_canvas_offsets()`, `update_canvas_offsets()` and `force_offsets_updating()`. Also, there is a new configuration option: `track_container_position`.

- API to change smooth factors of the camera's movement.

To change smooth factors of the camera's movement the following APIs have been implemented: `set_plock_smooth_factor()` and `get_plock_smooth_factor()` in `mouse.js` module (for Pointer Lock mode) and also `set_camera_smooth_factor()` and `get_camera_smooth_factor()` in `app.js` addon (for general use cases).

- New favicon picture has been added to Webplayer.

Changes

- New API spec for collision detection and ray casting.

Methods `append_collision_test()` and `append_ray_test()`, as well as `create_collision_sensor()` and `create_ray_sensor()` now have new spec, which is incompatible with the previous versions of Blend4Web engine. All developers should consider upgrading their applications to match this new behavior.

- Rendering to texture changes.

It's now possible to render scene into texture cyclically, e.g. when two scenes render one into another. The main constraint here is the requirement to have at least one scene, into which is nothing is being rendered.

- The option Apply Default Animation is now disabled if an object already have an NLA animation attached.

In cases when the object already have an NLA animation attached, the option Apply Default Animation is disabled to eliminate possible animation conflicts.

- Changed Hemi lamp behavior.

If the object is being illuminated by the Hemi lamp, the Lambert shading model will always be applied to its materials. This is done to match the Blender's behavior.

- Support for exported-to-HTML video textures in Firefox browser.

Since Firefox 38 an error with video textures exported to base64 was fixed, so it's now possible to use them in such browsers.

- Changed assignment of UV layers to match Blender's behavior.

Missing from node materials UV layers are determined automatically as it's done in Blender.

- Improved stability of exported to HTML video textures.

- Optimizations of CSM shadows.

- Depth shader optimizations.

- Billboard objects optimizations.

- Configuration option `resolution_factor` was renamed to `render_resolution_factor`.
- Improved support for particle emitters which have several materials.
 - Distribution of the particles to emitters as well as [vertex colors inheritance](#) is being done taking into account each material i.e mesh part.
- Changed Wind Bending inheritance on particle systems.
 - If Wind Bending Inheritance property is set to Instance then Wind bending property for emitter object is not switched off anymore.
- Updated messages about addon/engine version incompatibilities.
 - For more info see [version errors](#).
- Remove sensor locks API.
 - Unused sensor locks API was removed from `controls.js` module.
- Fixed behavior of node materials with missing Output node.

Fixes

- Fixes in `screenshooter.js` addon.
 - Fixed an error with impossibility to take a screenshot.
- Fixed a bug in `set_frame()` method from `nla.js` module.
 - Fixed `set_frame()` inaccuracy.
- Improved exported stability.
- Fixed a bug with addon removal/update on Windows.
 - Refined binary loader in addon.
- Fixed a bug with shading from SPOT/POINT lamps.
- Fixed incorrect behavior of coordinate calculations in methods `get_coords_x()` and `get_coords_y()` from `mouse.js` addon.
- Fixed calculations of alpha channel in Outline effect.
- Fixed Wind Bending effect error.
- Fixed an error when particle's Scale was not taken into account on particle systems.
- Fixed synchronization error on animated EMITTER particle systems.
- Fixed a bug with shadows on billboard objects.
- Fixed incorrect exporting of Override Mesh Boundings settings.
- Fixed a bug with billboard rendering on iPad.

Known Issues

- Problems with updating of the add-on.

It's strongly advised to restart Blender after installing a newer version of Addon/SDK.

- NVIDIA 331 driver in Linux can cause WebGL errors.
- There is a [bug](#) with video textures on Chrome 43 for Android.

Please update your Chrome browser to Beta or wait until the next Chrome update.

v15.05

New Features

- Glow effect.

Supported [an effect](#) which occurs when the light scatters in the atmosphere and inside of the human eye and looks like a halo around glowing objects.

- The local development server runs automatically.

A new option has been added to the addon settings. This option turns on automatic start of [local development server](#) upon opening Blender. With the help of this functional web applications in development can be run without any preparations.

- Cube reflections.

Apart from plane reflections, there are now cube reflections available. There is a new Reflection Type option available when Reflective flag is set on the object. Setting it to Cube turns this feature on.

- More NLA options supported.

Added support of Blender's NLA tools: Scale, Muted, Reversed and Repeat. The support of these tools broadens capabilities of interactive scene developers.

Furthermore, to control NLA through API a new `nla.js` module was added. This module contains methods like `play()`, `stop()`, `get_frame()`, `set_frame()` that can play/stop NLA and get/set the current frame. New methods have been involved in implementing control panel interface in the Viewer app.

- Increased rendering possibilities for sky textures.

Influence parameters for sky texture rendering are now supported. Those parameters are: Blend, Horizon, Zenith Up, Zenith Down, “Blend“, Negative, RGB to Intensity, DVar.

- In node materials, the engine now correctly processes connections between inputs and outputs of different types.

It is now possible to connect outputs of one type with inputs of another type ([Non-critical error](#)). Now Blender’s native behavior is supported by the engine.

- For Hair particles the options on the Rotation panel are now supported.

Now the engine fully supports the state of particles set in Blender. In particular not only location and scale are supported now, but rotation as well.

- Some demos for postprocessing effects demonstration were added.

Examples were prepared for the following effects: Bloom, Depth of Field, God Rays, Motion Blur and SSAO.

- Added a new module `container.js`.

DOM tree elements can be added with a specific depth relative to the depth of the canvas element with the help of `container.js`’s `insert_to_container()` method. This method replaces CSS property `z-index` because location depth of elements is now determined by their position in the container element.

- Improvements in the physical engine.

Margin property of physical elements and materials is now supported. This option allows for improved stability of object collision simulation. Bullet engine was updated to version 2.83.

- API for changing camera controls mode.

Added methods of [changing movement style of the camera](#). The control mode switch example can be found in [Code Snippets](#) app in the “Camera Move Styles” section. Also has been added `set_hover_pivot()` method. This method allows to shift the control point of HOVER camera.

Changes

- Reorganized SDK’s scene list.

All the scenes in the Viewer app has been sorted by groups: App contains finished apps, Demos contains demo-scenes and examples, Tutorial Exports contains tutorials source files.

- Added syntax highlight in Code Snippets app.

Code Snippets app now has a new design. Also it was optimized for low-resolution screens.

- API controls of video and canvas textures have been changed.

A new parameter `data_id` has been added to these textures' control methods. This parameter contains an ID of dynamically loaded scene.
- Handling of animated bone excess has been changed.

The skeletal animation now just turns off when exceeding the maximum number of bones. It resulted in shader compilation error and unstable application behavior before.
- Some particle system properties has been renamed and now they are turned off by default.

In particular, Hair particle system's properties Randomize Location And Size and Randomize Initial Rotation are turned off by default now.
- Doppler effect for speakers is now turned off in some browsers.

Doppler effect support in Web Audio has been pronounced as deprecated and will be removed in Chrome starting from version 45. Other browsers still support this functionality.
- Changed objects' behavior when both skeletal and vertex animation are applied.

If an object has both armature modifier and vertex animation applied on it, the armature modifier won't be exported.
- Rendering of particle system procedural animation (Wind Bending effect) has been optimized.
- The main `.json` and `.bin` scene files loading error handling has been improved.
- Windows 32 version of Blend4Web addon is now compiled natively.

This feature improves compatibility of the add-on with such systems.

Fixes

- The error that led to the wrong height of the description element in module "anchors.js" has been fixed.
- Support for Epiphany and other WebKit-based browsers.

Achieved by fixing the code which works differently in the different JavaScript engines.
- Gestures on Internet Explorer 11 were disabled for Microsoft Windows touch devices.

Previously, gestures usage (Windows Touch Gestures) was leading to unnecessary HTML-elements scaling and movement on such configurations. It is expected that correct gestures' behavior will be supported in further browser releases.
- Vertex animation with animated armature bake error was fixed.

- The error with rendering billboard objects on the iPad has been fixed.
- Node material's NLA animation applied to several objects was fixed.
- Fixed a bug related to the Motion Blur effect.

Known Issues

- Problems with updating of the add-on.

It's strongly advised to restart Blender after installing a newer version of Addon/SDK.

v15.04

New Features

- Deformations by using Shape Keys (Morphing).

Added support for object's [Morph targets](#) (known as [Shape Keys](#) in Blender). To apply such keys, use the `set_shape_key_value` method of the `geometry.js` module. Simple example of how to use such functionality is given in the [Code Snippets](#) app.

- Support for Horizon Color and Zenith Color background settings.

It's now possible to tweak scene background by using the [Horizon Color](#) and [Zenith Color](#) properties as well as the [Paper Sky](#), [Blend Sky](#) and [Real Sky](#) options directly from Blender.

- Support for the Gamma node.

We have implemented the [Gamma node](#) back in Blender v2.74. Now this node is finally supported by Blend4Web.

- Various improvements in the [Anchors](#) tool.

It's now possible to limit the pixel size of an annotation. Added support for dynamic loading/unloading of [Anchors](#). Implemented the possibility to hide and show [Anchors](#) by using the `show()/hide()` API functions and/or by the [NLA Script](#) tool.

- Shader optimizations.

Shader compiler improvements. Added the following features: local variables optimizations, brackets removal. Improved the performance of node materials.

- Physics engine optimizations.

To save the load time, the physics modules are now loaded only when explicitly required. Overall size of the modules has been decreased by 20%.

- Extended tools for physics debugging.

The new `physics_stat()` method has been added to the `debug` module. This method returns physics statistics such as the number of physics objects (separated by type), amount of geometry and other info. It is now also possible to display the number of physics iterations per second aka Physics FPS (activated in the config module).

- The new API method to attach objects to the camera independently from the camera's aspect ratio or the field of view.

Implemented in the `append_stiff_viewport()` method of the `constraints` module.

- The new module to perform transformations: “tsr.js”.

This new module makes it possible to apply a variety of transformations to objects by using versatile TSR vectors. Each TSR vector combines translation, scale and rotation (hence the name). These vectors may be used instead of matrices as a more convenient and effective way to apply transformations.

- The possibility to exclude any directories from being converted by the resource converter.

To exclude some directory from being converted by the `resource converter`, it is enough to place a file named `.b4w_no_conv` to this directory.

Changes

- The API documentation has changed its appearance. Links for quick access to methods and properties were added.
- Skeletal animation now takes into account the relative translation of an armature and a skinned object.

Native Blender's behavior is now supported. There is now no need to position an armature and an animated object in the same place and with the same rotation and scale.

- Independent translation, rotation and scale animations are now supported.

The animation system no more forces keyframes to be present in every channel, which makes it possible to save original values in unused channels or change them with API.

- World background support.

Background and sky can be enabled with the Sky Settings > Render Sky option under the World tab. It is turned off by default.

- The Uranium physics engine now consists of two modules.

There are now two physics modules instead of one: `uranium.js` - the engine's code and `uranium.js.mem` - the file for memory initialization. Both modules must be placed in the same directory.

- The glow effect together with its related components was renamed to Outline.

The new name better describes the principle of this effect: highlighting objects' edges.

- Limiting the camera translation using the “`append_semi_stiff_cam`” method of the “`constraints.js`” module is now possible only for the “EYE” type.

- Local Development Server in Blender changes.

Now, instead of the standard Python SimpleHTTPServer, the Tornado web server is used as the [local development server](#). The new server has greater performance and it also offers more options to disable browser cache.

- Keyboard controls for sliders in the Viewer application were added.

You can now control sliders with `<` and `>` keys.

- Changes in the “`update_object_animation`” method of the “`animation.js`” module.

The optional “`force_update`” parameter was added. It forces animated objects to be updated even when their animation is not being played back.

- API changes in the `mouse.js` module.

The `enable_mouse_hover_outline` and `disable_mouse_hover_outline` methods were added.

The following methods were declared deprecated and will be removed in the next releases: `enable_mouse_hover_glow` and `disable_mouse_hover_glow`.

- API changes in the `scenes.js` module.

The `outlining_is_enabled`, `set_outline_intensity`, `get_outline_intensity`, `apply_outline_anim`, `apply_outline_anim_def`, `clear_outline_anim`, `set_outline_color` and `get_outline_color` methods were added.

The following methods were declared deprecated and will be removed in the next releases: `set_glow_intensity`, `get_glow_intensity`, `apply_glow_anim`, `apply_glow_anim_def`, `clear_glow_anim`, `set_glow_color` and `get_glow_color`.

- Some settings were changed in the Object > Blend4Web panel.

The Enable Outline option was added to enable using the [outline effect](#) on the given object. Also, the Outline on Select option was added to activate

glow animation when the object is selected (previously this behavior was defined by the Selectable flag).

- New settings were added to the Scene > Blend4Web panel.

The Enable Object Outlining option was added to control the overall possibility of outlining. Similarly, the new Enable Object Selectable option controls the overall possibility of objects' selection.

- Now the following object properties: Apply Scale, Apply Modifiers, Export Vertex Animation, Export Edited Normals and Export Shape Keys are mutually exclusive.
- API changes in modules.

The new `is_armature` method was added to the API of the `util.js` module. It checks if the given object is of the `ARMATURE` type.

The new `get_parent` method was added to the API of the `constraints.js` module. It returns the parent object of the given object.

Fixes

- Fixed a bug in the “anchors.js” module which caused objects' descriptions to disappear.
- Fixed a bug in the Animation Baker script that occurred when there were armature objects in hidden layers.
- Fixed the camera's behavior while using “append_semi_stiff_cam” method of the “constraints.js” module.

Fixed correction of the camera's vertical axis relative to the parent object. Also the original camera orientation is now being taken into account. This can require some adjustments of the camera's rotation limits that are passed to this function.

- Fixed a bug with reloading of the playlist when it was empty.
- Fixed the buggy behavior of physical objects that occurred after deleting at least one of them from the scene.
- Fixed a bug that occurred when there were zero-scaled objects instanced through DupliGroups.
- Fixed a compilation error of the water shader occurred on Windows and some mobile devices.
- Fixed a bug that occurred when there were duplicates of animation keyframes.
- Actions from different files sharing one name can be now used for NLA animation.
- Fixed duplication of event listeners that occurred when the “pointerlock” function was repeatedly called.
- Fixed behavior of the “Alpha sort” transparency type for dynamic objects.

- Fixed an add-on compilation error that occurred on Windows without C++ 2010 runtime installed.
- Fixed a bug with billboard rendering on iPad.

v15.03

New Features

- New tool for adding annotations to 3D objects.

Now it is possible to assign anchors to empty objects. These anchors can be of three different types: “Annotations” - information from object’s meta-tags is used, “Custom Element” - a custom HTML-element from the current web-page can be used as annotation, “Generic” - an invisible anchor with coordinates calculated using anchors.js module API.

- Animation and API methods for Value and RGB nodes in node materials.

Now it is possible to animate not only Value nodes but also RGB nodes. Also, the corresponding API methods for changing such nodes were added in the objects.js module.

- New “Code Snippets” application.

This [application](#) was created to simplify access to the examples of engine’s functionality. It is also possible to look at the examples’ scripts. This application can be launched from the index.html file located in the Blend4Web SDK’s root directory.

- New control functions for the Glow effect.

New APIs were added in the scenes module: `get_glow_intensity()` and `get_glow_color()`.

- Improvements in the Scene Viewer.

Design of the “Home” button was changed. A new button “All objects selectable” was added. It allows to turn off automatic “Selectable” option assignment for all scene objects. Also, it is now possible to see the total number of shaders on the loaded scene.

- Dynamic copying of scene objects (instancing).

Now it is possible to dynamically [copy and remove](#) scene objects (to create and remove instances).

- Handling errors related to the B4W_PARALLAX Blend4Web-specific node.

In case of incorrect usage of the B4W_PARALLAX node, an [export error warning](#) is generated.

- New options in the application’s builder.

There are now new options in the application builder: `-j` and `-c`. They add scripts and styles correspondingly to the exceptions in order to be not compiled.

- Experimental Blend4Web render engine.

It can be turned on in the addon settings using the “Register Blend4Web render engine (Experimental)” flag. This mode is designed to simplify customization of scene properties. Also, it simplifies the interface by removing unsupported panels. At the moment, it is not possible to edit shader node tree in the Blend4Web render mode.

Changes

- Origin for counting off the camera limits has been changed.

Setting camera movement limits via API now perfectly corresponds to [values](#) measured in the engine’s coordinate system. Setting horizontal limits for the TARGET camera in the Blender’s world space has been changed. Thus, it may require changeovers for old scenes.

- Documentation update for the camera settings.
- Horizontal and vertical limits of the camera rotation are completely independent from each other.
- Some APIs in the camera.js module were changed.

APIs of the camera.js module have undergone a number of changes.

New methods were added: `is_target_camera`, `is_eye_camera`, `is_hover_camera`, `rotate_camera`, `rotate_target_camera`, `rotate_eye_camera`, `rotate_hover_camera`, `get_camera_angles`, `hover_cam_set_translation`.

The following methods were declared as deprecated and will be removed in the next releases: `rotate_pivot`, `rotate_hover_cam`, `rotate`, `set_eye_params`, `get_angles`, `translate_hover_cam_v`, `set_hover_cam_angle`.

The `set_ortho_scale` and `get_ortho_scale` methods now print error message when they are applied to the Orthographic camera. The behavior of the `get_hover_angle_limits` method was also changed. This method now returns angle limits for the HOVER camera in the [down, up] format instead of [up, down] as it was before.

- The lighting system was significantly optimized.

Many of the lamp props are calculated at the compile time now. Now, there is no 4 lamp restriction is imposed for some mobile devices.

- The HTML layout method was changed for apps using the app module.

Now, upon initializing an application using the `app.js` module, the dimensions of the created `<canvas>` element are completely determined by the size of the container element. Thus, if a `<div>` element is used as a container, the size of `<canvas>` will be zero by default since `div`'s default size is zero. You can set correct parameters for the container with CSS and `inline-style`. Also, you have to use `resize_to_container()` method from the `app` module when the container is changed. The same effect may be achieved if the `autoresize` option is set upon initializing the application (in the `app.init()` function). The low level method for changing the element's dimensions with `main.resize()` function is still supported.

- Now, the `enable_controls()` function from the `app` module should be called without any parameters.
- Deprecated API methods were removed.

`textures.js` module : `stop_video`.

`scenes.js` module: `add_object`, `get_screen_scenes`, `set_light_pos`, `set_light_direction`, `set_dir_light_color`, `get_lights_names`, `remove_all`, `check_collision`, `check_ray_hit`, `get_appended_objs`, `get_object_by_empty_name`.

`physics.js` module: `set_character_dist_to_water`.

`material.js` module: `set_batch_param`, `set_max_bones`, `max_bones`.

`main.js` module: `set_shaders_dir`, `set_texture_quality`.

`data.js` module: `get_bpy_world`.

`controls.js` module: `sensor_make_positive`, `sensor_make_negative`.

`camera.js` module: `change_eye_target_dist` (deprecated `MS_CONTROLS` was also removed).

- There are now new conditions to allow changing object's position via API.

The functions from the `transform.js` module related to changing object position can be now applied to [dynamic objects](#) only.

- You can now use `TEXTURE` nodes without textures.

In this case the rendering of the node material completely corresponds to Blender.

- Updated the procedure of compatibility checks for versions of exported files and the engine itself.

The engine will report about the scene's incompatibility by printing [messages in the browser console](#).

- The “Do Not Batch” property was renamed to “Force Dynamic Object”

This option instructs the engine that the object must be dynamic regardless of other settings. Now its name is more clear.

Fixes

- Fixed camera autorotate feature of the web player.
- Fixed an error related to the fullscreen mode in the Web Player.
- Fixed an error related to the determination of the camera's angular coordinates in some positions.
- Fixed an error with camera autorotation if the horizontal limits are enabled.
- Fixed an error when Blend4Web-specific nodes were being added multiple times to a .blend file.
- Fixed a bug with replacing materials by using the “inherit_material” function from the “material.js” module.
- Fixed an error occurred while rendering reflections on an object which has been changed through the “material.js” module APIs.
- Fixed generation of the debugging wireframe spheres.
- Fixed optimization of the TEXTURE nodes in node materials.
- Fixed “Clamp” option behavior in the MixRGB (Linear Light) node.
- Fixed an export error occurred when an object shares its mesh with another object and one of the following flags is set to true: “Apply Scale”, “Apply Modifiers”, “Export Vertex Animation” or “Export Edited Normals”.
- Fixed an error with “Blend4Web > Preserve Global Orientation and Scale” option on some mobile devices.
- Fixed fog rendering error in some versions of Chrome/Firefox under Windows.

Known Issues

- Problems with updating of the add-on.

It's strongly advised to restart Blender after installing a newer version of Addon/SDK.
- Video textures do not work in Firefox for scenes exported as HTML files.

v15.02

New Features

- The local development server can be run from Blender.

It's possible now to run [local development server](#) when using Blend4Web SDK. This server allows fast access to the Blend4Web SDK content and

also make it possible to [automatically open exported scenes](#) in the Viewer application.

- Support for Spot lights shadows.

Shadows for Spot lamps were processed in the same way as for Sun lamps. Now the calculations are performed in the same way as it's done in blender i.e the light scattering is taken into account.

- Added/improved support for “Metaball”, “Surface” and “Curve” objects.

Support for Metaball, Surface and Curve objects was added. Objects of these types are automatically converted into meshes during export. Support for Curve objects in modifiers was preserved.

- Social networks buttons are added to the Web Player.

These buttons allow placing a link and a description to the 3D scene in one of the four popular social networks.

- Added support for editing the list of Viewer scenes directly in Blender.

It is now possible to [edit assets.json file](#) with a list of Viewer scenes inside Blender. This works only when using Blend4Web SDK.

- Screenshots can now be taken in the Viewer application.

- New `fallback_video` option is added to the Web Player.

Now the user can choose a video file to play instead of 3D content on systems without WebGL support. It is possible with the help of the new `fallback_video=/path/to/video/` option.

- Improved rendering to texture functionality.

Added support for rendering scenes into several textures at a time. Scenes now can have any nesting level.

- Billboards now can save orientation and scale in world coordinates.

To use the feature you need to set [Blend4Web > Preserve global orientation and scale flag](#) in the object's settings panel.

- Improvements on the main SDK web page.

It is now possible to find out the version of the SDK and check the system for WebGL compatibility on the main web page.

- Added support for the Clamp flag in MATH and MIX_RGB nodes

At first this functionality was released in Blender 2.73, and now it's also supported in the engine.

- Considerable improvements in rendering quality on systems without depth-texture support.

Supported rendering features on systems without depth-texture support were extended. There are such effects available now: reflections, bloom, glow, motion blur, anti-aliasing.

- New documentation is added.

Added documentation for the `vec3`, `vec4`, `quat`, `mat3`, `mat4` modules and for the global namespace `b4w`. Documentation web pages design was improved.

- Support for several engine instances on the same web page.

Several engine instances can now work simultaneously, by specifying the namespace on engine's initialization stage.

- Possibility to use SDK on Apple macOS.

On macOS all SDK functionality including engine and applications building, resource conversation and documentation generation is now available.

- The new `set_trans_pivot()` method is added to the camera module.

This function allows setting an arbitrary position of the pivot point and the position of the camera of the `Target` type.

- A new “version“ property is added to the “project.py“ utility.

This property allows adding a version to the scripts and styles of the compiled application.

Changes

- Now it is possible to add options with the same names via browser address bar.

A new optional parameter `allow_param_array` is added to `get_url_params()` function of `app` module. It is set to `false` by default. Setting this parameter to `true` leads to a merge of identical functions into a massive, other way the last one will be used.

- Improved “Background Music“ speaker.

Now the user can specify parameters of delay and playback time.

- Blend-file now includes special Blend4Web nodes by default.

Now there's no need to add [Blend4Web special nodes](#) into a file. It is available in both SDK and addon versions of Blend4Web.

- Changed export of empty “Mesh” objects.

Now Mesh objects without polygons are exported as `Empty`.

- Changes in the “light.js” module.

Added function `get_light_type`; functions `get_light_params` and `set_light_params` now get object LAMP instead of objects name. Also

the user now can change `spot_blend`, `spot_size` and `distance` properties of the SPOT light source through those functions.

- Improved refractions on LOW quality settings.

New simplified (without distortion) refraction model is now used when LOW quality is chosen.

- Shader nodes optimization.
- Now automatic camera rotation can be turned off by touching touch screen.

Fixes

- Corrected behavior of the preloader for the Web Player.

Some artifacts could be visible on B4W logo while opening Web Player.

- Fixed an error in rendering of one-cascaded shadows. The error was related to appearing of a hard non-lighted line on the cascade border.
- Fixed an error related to names collision while linking objects in Blender.
- Fixed an error with optimization of SDK apps.
- Fixed export error of flat shaded meshes on Linux x32.
- Fixed incorrect behavior of Target camera in particular cases.
- Fixed an error when using a shadow map with size exceeding device limits.
- Fixed an error that leads to FPS drop in Firefox 35/36 on Windows when shadows are turned ON.

Known Issues

- Problems with updating of the add-on.

It's strongly advised to restart Blender after installing a newer version of Addon/SDK.

- Video textures do not work in Firefox for scenes exported as HTML files.

v15.01

New Features

- Support for panning on touchscreen devices.

Panning is performed by swiping two fingers on the surface of the screen.

- Support for “Text” objects.

These objects are now automatically converted to meshes during export.

- Extended support for the NLA Script tool.

Added new logic slots: Show Object and Hide Object used for hiding and showing the objects, Page Redirect - for redirecting to other webpages, Page Param - for storing any webpage parameter in given numerical register. Simplified usage of Select & Jump and Select & Play slots. Now it's not required to specify Selectable property on selectable objects.

- Support for high definition displays (HIDPI, Retina).

The HIDPI mode allows to achieve considerable improvement of picture quality on devices with high resolution. This mode is activated automatically upon application startup if ULTRA quality profile has been selected. If necessary, high resolution can be turned on for other quality profiles.

- Support orthographic camera scaling.

An API to change the Orthographic camera scale has been added (Orthographic scale in Blender).

- “autorotate” option has been added to the webplayer.

The option `autorotate` is used to turn on the automatic camera rotation as soon as the scene loads.

- Simplified keyboard control mode has been added to function `enable_camera_controls`.

The mode is enabled by passing the optional parameter `disable_letter_controls`. Thus, the keyboard controls with letter keys (WASD and so on) will be turned off. This feature can be used in cases when you need to use the letter keys for purposes other than moving the camera.

- Support for gyroscope on mobile devices.

To work with gyroscope on mobile devices the two sensors was implemented. The first sensor allows to operate with current device position compared with the previous one (position delta). It's created by using the function `create_gyro_delta_sensor` from “controls.js” module. The second sensor returns current device angle and created by `create_gyro_angles_sensor` from “controls.js” module. It's worth to mention that all angles are given in radians. Also the special addon “gyroscope.js” was created. This addon implements simple camera movements due to device rotation. You can find an example of using such feature in our Viewer application by selecting the “Gyroscope” menu option.

- New “Do not Render” property has been added to material settings.

Enabling the property allows to hide parts of the scene objects which use such material.

- Support for video-textures on IE 11 and iPhone.

The support is achieved by creating a new video-sequence format, *.seq. For more info check the following [topic in documentation](#).

- Support for “title” tag in Web Player.

The Web Player’s title (shown as web browser header) is now extracted from JSON file of the loaded scene. For more info about this feature check the following [topic in documentation](#).

- Support for meta tags in Blender.

It’s now possible to append meta tag information to scenes and objects in Blender. Possible tags for scenes are “title” and “description”. Possible tags for objects are “title”, “description” and “category”.

- Added support for execution of user-defined functions every frame.

To help users to create sophisticated application the new function `append_loop_cb` has been added to “main.js” module. This function allows to execute given callback every frame. This callback has two parameters: time since the application start and time delta between current and previous frame. Both parameters are in seconds. To cancel the callback execution every frame you should remove it by using the `remove_loop_cb` function from the module “main.js”.

- Added support for simple preloader screen animation.

To create an application with animated preloader pass an option “preloader_fadeout” with the value “true” to the function `create_simple_preloader` from “preloader.js” module.

- Added support to export converted media files to HTML file.

Now then you export HTML files it’s possible to store converted files in them. To do so you need to enable “Export Converted Media” option in the [export options](#).

- Added support for using min50 and dds textures in Web Player.

To enable this feature pass “compressed_textures” parameter to Web Player.

Changes

- SDK file hierarchy was simplified.

The external directory was removed, all its content was moved to the upper level - in the root directory of the SDK. The file with the list of the scenes used by the Viewer application is now located in `apps_dev/viewer` directory.

- Changed camera autorotation behavior (experimental).

If the camera limits are present, the camera smoothly slows down when approaching the limits, then moves in the opposite direction.

- The usage of “Special: Collision“ property was changed.
Earlier, enabling the option automatically resulted in objects’ hiding. Now, to do the same thing, you have to specify Do not Render property in the material settings.
- Changed suffix for converted media files.
Old *.lossconv.* suffix was replaced by *.altconv.*.
- Behavior of “Do not render” object property was changed.
Now, when the option is activated, an object’s physics is not disabled. The object simply becomes invisible.
- Improved the SDK structure.
Free and Pro SDK now come with the new and more polished examples; old and arid examples were dropped.

Fixes

- When using “Panoramic” camera type in Blender the camera automatically obtains “Perspective” type when exported.
- Fixed bug with “Target” camera dragging in rare cases.
- Minor fixes in the “B4W Anim Baker” addon.
- Fixed issue with sound for scenes with multiple cameras.
- Improved stability of “Timer” sensors in “controls” module.
- Fixed issue when browsing exported HTMLs in IE browser.
- Video texture optimizations. Now the video texture is not updated for suspended video playback.
- Fixed rendering issue in node materials with “REFRACTION“ node.

Known Issues

- Problems with updating of the add-on.
It’s strongly advised to restart Blender after installing a newer version of Addon/SDK.
- Video textures do not work in Firefox for scenes exported as HTML files.
- Slow and unstable rendering of depth textures in Firefox 35.
In various scenes the FPS is degraded when shadows are turned on. There is also an incorrect rendering of transparent materials. The issue is reported [here](#) and is to be fixed in the future browser updates.

v14.12

New Features

- Camera velocity settings are now available.

Now `camera movement velocity` can be set up, including translation, rotation and zooming. Velocity for all camera types (Target, Hover, Eye) can be tweaked both using Blender UI and through Blend4Web API.

- Mipmapping is now supported for Canvas textures.

We have added mipmapping support for `Canvas textures`.

- Full support for the “MAPPING” node.

Now all Vector type options available for the MAPPING node are supported, including Texture, Point, Vector and Normal.

- Glow on mouse over.

API in the `mouse.js` module were created for the effect of outlining the objects under the mouse pointer. Also, for purposes of controlling this effect, `enable_mouse_hover_glow()` and `disable_mouse_hover_glow()` methods were added. The objects should have `Object > Blend4Web > Selectable` checkbox enabled.

- A brand new app building system.

Now, the users can develop their apps right in the SDK thanks to the new `project.py` utility. [This script](#) makes it possible to build the apps together with the engine, to minify JavaScript and CSS files and to export the final apps to be deployed on a server.

Changes

- Removed support for deprecated “UV translation velocity” texture settings.

We recommend to use node materials instead.

- Removed deprecated “Levels of Detail” user interface.

This functionality can be used through Blender’s standard “Levels of Detail” tool.

- The `pointerlock.js` add-on was renamed into `mouse.js`.

- A `mouseup` event is now fired when the mouse pointer is leaving the app viewport.

So the problem with broken camera controls is no longer observed.

- Error message about “Clear parent inverse” is no more shown.

Before, when using parenting, it was required to reset translation, rotation and scale of child objects (Object > Parent > Clear Parent Inverse). Now such transformation is natively supported by the engine.

- “Apply scale” option no longer applies modifiers.

As before, [Apply modifiers](#) should be used in order to apply modifiers.

- Use of normal maps in node materials no longer requires a Material or Extended Material node.

In some cases (e.g. refraction) normal maps can be used in shadeless materials.

Fixes

- Fixed audio playback error occurred when using NLA.

This happened due to insufficient float number precision.

- Fixed incorrect rendering of light sources on mobile devices.
- Layering shadows is fixed when multiple active light sources are present.

Now the shadows are calculated like in Blender, that is areas illuminated by other light sources are not darkened.

- Node material rendering error has been fixed.

The error occurred when a MATERIAL node (or MATERIAL_EXT) with a linked (from another .blend file) material was used.

- Animation baker (“B4W Animation Bake” operator) no longer resets an armature pose.

Now, when using the [animation baking tool](#), the armature pose is being left intact.

- Fixed jerky camera movement upon application startup.
- Fixed error with incorrect determination of the camera’s horizontal movement limits.
- Fixed error occurred when unused textures were exported.

Known Issues

- Problems with updating of the add-on.

It’s strongly advised to restart Blender after installing a newer version of Addon/SDK.

- Video textures do not work in Firefox for scenes exported as HTML files.

v14.11

New Features

- Video textures support.

Video textures are now supported for Image or Movie textures.

- Frame rate.

Frame rate for animation and video textures can now be changed through the Scene > Dimensions > Frame rate option.

- Canvas textures support.

A canvas HTML element can be now used as a [texture](#). The workflow is described in the [manual](#).

- Camera panning.

In the mode when the camera is rotating around a single point (Target) the users now have the ability to move the pivot point within the view plane (so called camera panning) while the right or middle mouse buttons are pressed. This function is turned on by default and can be turned off in Blender settings at need.

- New camera control mode - Hover.

The Hover mode is now available when the camera is gliding over the horizontal plane (including zooming in and out). This camera mode makes it possible to realize scenarios for a convenient viewing of scenes which are spread in two dimensions (rooms, game levels).

- The SDK now contains a root index HTML webpage for simplifying navigation within the distribution.

- The resource converter now has the ability to convert videos.

- We have added a build system which was absent in previous public SDK distributions.

- The export Strict mode is implemented in the add-on.

Activating Strict mode gives the possibility to display all possible errors and warnings connected with incorrect scene settings. The option is useful for final scene debugging for getting the most correct and optimized resource files.

- Audio playback support for iOS devices.

Changes

- The webplayer's "bg" parameter is renamed to "fallback_image".

This option also has changed its behavior. If the `fallback_image` is defined the error message that WebGL is unavailable is not shown anymore, instead the user sees just the image.

- If there are no sound sources in the scene the sound mute button is no longer shown in the webplayer.
- Generic materials workflow is now more predictable.
- The “`mouse_down`” sensor provides the code of the mouse button pressed. This code can be obtained from the payload sensor’s parameter.
- Hair particle systems can be now exported significantly faster.

Fixes

- Normal maps now work with Generated and Normal texture coordinates.
Using UV layers is no more required for normal maps.
- Fixed the problem with the wrong path to the physics engine in the webplayer.
This error arose when `uranium.js` was moved out of the directory containing the main HTML file of the webplayer.
- In the add-on we have fixed the problem with packed textures. Export crashed when the “Automatically Pack Into `.blend`” option was enabled.

Known Issues

- Problems with updating of the add-on.
It’s strongly advised to restart Blender after installing a newer version of Addon/SDK.

v14.10

New Features

- A new Web Player.
The new minimalistic Web Player design blends perfectly with any 3D scenes. It has a simplified user interface and build-in help. The Web Player works on all devices including mobile ones.
- Improved shadows.
It’s now possible to choose a non-cascaded shadow model, based on a single optimized shadow map. Such model is easier to configure and suits well for relatively small scenes. For more info see the [docs](#).

- Many NLA system improvements.

It's now possible to create a complex logic using the Conditional Jump, Register Store, Math Operation NLA Script logic blocks and register-stored variables.

It's now possible to use all types of supported animations in the NLA, including sound playback, vertex animation and particle emission. It's now possible to play different animation types simultaneously.

- Supported objects billboarding.

The objects received the new set of [options](#), allowing to configure billboarding.

- The “XYZ Euler” mode is supported for animating rotations.

Object and skeletal animations now support the XYZ Euler mode for rotations.

- Support for the GENERATED texture coordinates.
- Support for Cross-origin resource sharing (CORS).
- Scene export process simplified.

The range of material export errors are now not blocking the export. Instead, this material will be highlighted pink at scene loading. Detailed error descriptions can be found in the [manual](#).

- Added support for the “Do not export” option for particle systems.
- Improved stability on iOS devices.

Changes

- Changed SDK path setting for HTML export.

It's now needed to set the SDK path setting for HTML export to SDK root directory. Earlier it was required to provide the full path to embed application. Pay attention, the old behavior is not supported anymore.

- Deprecated the “UV translation velocity” option.

The option will be removed since version 14.12.

- Removed option “Do not export” from the “Object data” panel.
- Removed “Blend4Web > Animation > Cyclic” option from the object properties panel.

Instead, one should use Blend4Web > Animation > Behavior option located in the same place. Scenes with default animations may work incorrectly, so they need behavior property to be set to Cyclic.

- Modified SSAO algorithm realization.

The new implementation is much faster and shows better quality. The settings of the algorithm are changed too. For more info see the [manual section](#).

Fixes

- Fixed rendering error for HALO materials.
- Fixed a rendering error when an object with the enabled “Force Dynamic Object” property has a parent object.
- Fixed error with keyboard shortcuts in Blender.

Fixed error with inability to assign keyboard shortcuts in Blender for export menu items:File->Export->Blend4Web(.json) and File->Export->Blend4Web(.html).

- Fixed crash when loading textures with size exceeding device limits.
- Fixed node material errors resulting in unstable engine behavior.
- Fixed error in node materials that contained complex Node Groups.
- Fixed errors of shaders compilation on devices with mobile graphics Qualcomm Adreno 305.
- Fixed rendering error when using REFRACTION nodes in transparent materials.
- Fixed an issue in “B4W Vertex Anim Baker” tool when current frame reset was occurred after using bake.

Known Issues

- Problems with updating of the add-on.

It's strongly advised to restart Blender after installing a newer version of Addon/SDK.

- Normal maps don't work for Generated texture type.

It is necessary to use UV mapping for normal maps.

v14.09

New Features

- ABSOLUTE type support for the MATH node.
- Support for LEVELS_OF_QUALITY special node.

Allows to control the material's complexity depending on the quality profile which is specified by the user upon engine start.

- Support for SMOOTHSTEP special node.

Simplifies the creation of some effects in node materials.

- Node groups support.

Node groups allow the sharing of node blocks between materials.

- The ability to output intermediate rendering results for debugging.

The rendering result for a certain stage can be now output above the main picture. This can be set up in the config.js module through the debug_sub options.

- The logic for controlling Blender's NLA animation using a visual editor has been implemented.

The NLA Script tool has been added to Blender's interface to allow the implementing of simple scenarios using visual blocks, for example playing an animation in response to the user actions.

- Multiple sensor system improvements.

It is now permitted to register sensor manifolds globally using a controls module method with no connection to any object. To do this null should be passed into the corresponding API. The sensor logic is processed in a more predictable and robust way according to the sequence in which their manifolds are created. Callbacks of the user action events are now assigned using the register_<input_type>_events() functions. To these functions it is now possible to pass the prevent_default flag which allows to unblock the standard browser behavior for the corresponding events.

- The Web Player now supports physics.

Works only in the Web Player version where JSON files are loaded separately. Physics still not supported in the single HTML files.

- Skeletal animation mixing is now supported.

The animation.js module now contains API for smooth transitions between skeletal animations: get_skel_mix_factor() - for getting the current mixing factor value and set_skel_mix_factor() - for setting it.

- The Value node can now be animated in node materials.

The functionality is similar to other animation types. Working in NLA is also supported.

- Diffuse and Specular lamp's properties are now supported.

- The possibility to render a transparent object above other objects on the scene.

Activated with the Render above all checkbox for transparent materials (i.e. not Opaque).

- Scale is applied automatically to the object mesh.
Activated by enabling the Apply scale checkbox in the object settings.
- High quality profile (including shadows, dynamic reflections and anti-aliasing) has been implemented for iOS.

Changes

- Shadow rendering improved.
Shadow rendering system is significantly changed: it is now based on the Stable Cascaded Shadow Maps technique. This technique allows to greatly diminish the flickering of shadow edges when the camera moves. Smoothing is implemented between cascades. Also shadows of the last cascade fade out at distancing. Softened shadows are rendered using the Percentage Closer Shadows technique. The shadows' user settings are reworked and simplified. Now its possible to tweak the size of shadow maps, blur ratio and the setting for removing self-shadowing artifacts. The new settings are [documented](#) in detail.
- In the Web Player graphics quality settings are now saved independently for each scene.
- The behavior of the app configuration parameters has been changed: `physics_uranium_path`, `smaa_search_texture_path` and `smaa_area_texture_path`.
These parameters are now calculated automatically depending on the running HTML files location, if they haven't been overridden during the app's initialization.
- Transition is completed to the system of modules which are linked via `b4w.require()` call.
This also means that starting from the current version its impossible to call modules in the engine's release version using the old `b4w.<module>` namespaces. For compatibility purposes the `ns_compat.js` add-on has been implemented, the linking of which allows to restore the old behavior.
- The Web Player's control panel can now be hidden.
- Skeletal animation is now applied to armature objects only.
There is no need to apply skeletal animation to MESH objects. If they are linked to some animated armature, their skinning will be automatic.
- Demos and tutorials are updated according to the newly implemented features.

Fixes

- The preloader didn't disappear in case of a loading error (texture or sound file).

- Lagging during scaling and turning on mobile devices is fixed.
- TARGET-type camera shimmering has been removed for small turnings.
- EYE-type camera controls was fixed for mobile devices.
- The Farm demo controls are improved for Safari browser.
- Errors concerning using the unsupported shading models in node materials are now fixed.
- “Selectable” option now works for the objects without materials.
- There is no longer need to enable “Force Dynamic Object” for the objects that are animated using NLA.
- The particle system error when the object being instanced is parented to another object, has been fixed.

Known Issues

- Problems with updating of the add-on.

It's strongly advised to restart Blender after installing a newer version of Addon/SDK.

- Armature animation mixing doesn't work with some browsers.

If skeletal animation mixing API brings unexpected errors, it is necessary to override standard `Math.sign` function as follows:

```
var m_util = require("util");  
Math.sign = m_util.sign;
```

- `genindex`
- `search`

Symbols

3D Modeling, 3

A

add-on, 89

addon

 initialization errors, 100

anaglyph, 311

animation, 357

anti-aliasing, 311

B

background, 299

batch, 72

Blend4Web, 1

Blender, 3

boundings, 72

browser, 4

browser technologies, 4

C

cluster, 72

Color Correction, 392

compiling shaders, 450

 errors, 454

 import/export directives, 452

 obfuscation, 451

 optimization, 451

 recommendations and limitations, 452

 validation, 451

 WebGL Extensions, 454

crepuscular rays, 307

D

depth of field, 303

diffuse map, 320

DOF, 303

drivers, 5

E

engine, 1

engine features, 5

export, 42

 errors, 102

 warnings about export errors, 104

G

get object, 152

git, 456

 adding and removing files, 460

 checking the status, 458

 commit, 461

 individual settings, 458

 preparing for commit, 459

 resolving conflicts, 464

 synchronization between repositories,
 462

 tags, 467

god rays, 307

graphics engine, 1

I

interactive graphics, 5

L

light sources, 288

lighting, 286

M

matcap, 319

material capture, 319

materials, 200

 halo, 210

 lighting parameters, 201

 nodes, 225, 227, 228

- reflection, 205
- rendering properties, 208
- specific parameters, 210
- transparency, 203
- viewport properties, 209

motion blur, 302

N

- normals, 167
 - editor, 167

O

Object Transform API, 151

outline glow, 308

P

parallax mapping, 321

- particle system
 - fluids, 335
 - instancing, 345

Q

quaternion, 155

R

- reflection, 205
 - dynamic, 206
 - fresnel effect, 207
 - static, 205

release notes, 479

render, 72

render-to-texture, 332

RTT, 332

S

scene, 112

screen-space ambient occlusion, 305

- sensor, 436
 - manifold, 436

- shading, 287
 - types, 287

shoreline, 379

shoreline data, 379

skydome, 330

SSAO, 305

T

- textures, 317
 - diffuse, 320

- environment map, 327

- height map, 321

- mirror map, 329

- normal map, 321

- render to, 332

- settings, 319

- sky, 330

- specular map, 320

- stencil map, 323

- types, 318

three-dimensional engine, 1

tools

- debug, 72

transparency, 203

- settings, 205

- types, 203

V

version

- errors, 101

video card, 5

view, 72

viewer, 69

- adding scenes, 42
- launch, 94

W

web player, 83

- WebGL, 2
 - advantages, 3
 - browser support, 2

wireframe, 72